

ENGINEERING
TOMORROW

Danfoss

Global Master Catalog

Danfoss Hansen® Quick Disconnect Couplings



Table of Contents

Fluid transfer & Hydraulic	9	High Pressure	105	Industrial Gas	157
Ball latch poppet		Screw to connect		Thread to connect	
H15000 Series	11	HP3 Series	107	LF Series	159
IA Series	13	W56000 Series	108	600/700 Series	161
5600 Series	16	Ball latch			
H5000 Series	23	FD35 Series	109		
FD72/76 Series	32	UH Series	111		
HK Series	33				
LL4KP26	42	Water blast	112	Food and Beverage	166
LL2MS	43	FD69 Series	114	Push to connect	
HKFR Series	44			2HKGL Series	167
2HKIG/IL Series	45	Check valves	116		
FD48 Series	48	R4000 Series	117	Pneumatic	171
Ball latch straight through				Push button	
ST Series	49	Diagnostic	124	Safeline Series	175
L7000 Series	53	Screw to connect		Ball latch	
Flat face		FD15 Series	126	1000/400/500 Series	186
FF Series	62	FD90 Series	128	G600/1900/T1100/T1300 Series	194
FFCUP Series	67	FF14802 pressure gauge kit Series	130	Push to connect	
MLFF Series	69	FS Flow sensor Series	132	3000/4000/5000/6000 Series	203
Multi-FF Series	70			AutoFlo23/24 Series	213
FD49 Series	74	Breathing air	133	210/310 Series	217
FD96 Series	76	Screw to connect		100 Series	220
K8000 Series	78	FD17 Series	135	180/280 Series	222
Q9000 Series	79	Push to connect		Full Bore Series	224
MLDB Series	80	Safe Breathe Series	136	Gas-mate Series	226
Safety breakaway Series	82	Ball latch		Push to connect with ring lock sleeve	
Screw to connect		2500 Series	138	2RL/3RL Series	228
W36000 Series	84			Accessory	
GA90090 Series	87	Thermal Management	139	Flex-Air Series	233
IP Series	89	Flat face		Blowguns	235
W6000 Series	90	ADB Series	141	Adapters	236
5100 Series	96	Bajonette			
FD85 Series	100	FD83 Series	143	FLOCS	241
FD86 Series	102	Push to connect		FD14 Series	243
W46000 Series	104	UQD Series	145	FLOCS	254
		Thread to connect			
		Flo-Temp Series	147	Quick Seal	261
				PR Series	265
		Refrigerant	150	TC/MTC/RTC/OTC Series	267
		Thread to connect		H and K Series	270
		5400 Series	152		

Introduction to Danfoss Quick Disconnect Couplings

Since the invention of the quick-release coupling by Fred Hansen in 1915, the Hansen name has been known for setting new industry standards in fluid conveyance—building a strong global reputation for performance, resilience and reliability.

The innovative design of Danfoss Hansen quick disconnect couplings enables higher flow rates with an optimized flow path, reducing pressure drops and increasing overall system efficiency. In turn, this decreases component wear and tear, lowers application energy consumption, and reduces system space and weight—all of which can slash both fuel consumption and cost of ownership.

Danfoss Hansen quick disconnect couplings also come with Dura-Kote™ plating as standard, offering exceptional corrosion protection that prevents red rust for up to 1000 hours, extending their lifespan and reducing maintenance demands.

"Danfoss Hansen quick disconnect couplings are well known for outstanding performance and robust design, driving leak-free operations". "Our Danfoss Hansen brand recalls this long heritage of application excellence across a multitude of different markets."

At the same time, it also marks the opening of a new chapter in engineering tomorrow for hydraulic, pneumatic, and fluid transfer applications. Our experts will continue pioneering new improvements to ensure Danfoss Hansen couplings remain a clear market leader long into the future.

The updated Danfoss Hansen product line also offers customers a plethora of options. Available in a wide variety of materials and sizes, along with optimized sealing solutions, the couplings are highly customizable based on the performance and cost demands of a customer's specific application.



Safety Information for Danfoss Quick Disconnect Couplings

1.0 General Instructions.

1.1 Scope. The scope of this safety bulletin is to warn against improper selection, use, installation, etc. of Danfoss coupling products.

1.2 Distribution. A copy of this safety bulletin should be distributed to all individuals responsible for using and/or selecting Danfoss coupling products.

1.3 Fail-Safe. Design all systems and equipment for fail-safe operation such that failure of any component does not result in personal injury and/or property damage.

1.4 User Responsibility. It is the sole responsibility of the user to select and determine that the Danfoss product is compatible with the end use application. The user is responsible for reading and following this safety bulletin as well as any instructions or literature on the Danfoss product being used. The user must provide necessary product warnings for Danfoss couplings products, used with systems or equipment, to the operators of the systems or equipment.

1.5 Usage with other Manufacturers' Products. When using Danfoss coupling products with other manufacturers' adapters, hoses, etc., do not exceed the lowest pressure rating of any of the components being used or rupture may result.

2.0 Selection of Danfoss Couplings.

2.1 Pressure. Ensure that the maximum operating pressure of the system or equipment does not exceed the rated operating pressure of the Danfoss coupling product or rupture may result.

2.2 Fluid Compatibility. Verify that all components (seals, metals, etc.) are compatible with the fluid being conveyed. Failure to do so may result in high speed fluid discharge and/or leakage of fluids which may be flammable, toxic, at extreme temperatures, or otherwise harmful.

2.3 Temperature. Ensure that the maximum operating temperature of the system or equipment does not exceed the rated operating temperature of the Danfoss coupling product (including seals) or rupture may result.

2.4 Coupling Size. Use properly sized couplings such that there is not a large pressure drop across them thus avoiding system damage due to excessive heat generation or failure of internal components.

2.5 Sleeve Lock. Use sleeve locks or threaded couplings where there is the possibility of accidental disconnection. Failure to utilize sleeve locks or threaded couplings in these applications may result in hose whip, expelled components, high speed fluid discharge, system damage, or leakage of fluids which may be flammable, toxic, at extreme temperatures, or otherwise harmful.

2.6 Connect or Disconnect Under Pressure.

If connection and/or disconnection of couplings under pressure is a requirement, only use couplings designed for connection/disconnection under pressure. Failure to utilize this type of coupling in that application may result in hose whip, expelled components, high speed fluid discharge, and/or system damage. Be certain not to confuse the rated operating pressure with the rated connect/disconnect under pressure.

2.7 Environment. Ensure that Danfoss couplings are compatible with the surrounding environment. The surrounding environment may be heat, salt water, moisture, chemicals, and the like. Failure to protect against an adverse environment may cause system damage, premature failure, and/or leakage of fluids which may be flammable, toxic, at extreme temperatures, or otherwise harmful.

2.8 External Loads. Avoid any external loads such as side loads, tensile loads, vibration, etc. Failure to do so may result in accidental disconnection, premature failure, system damage, and/or leakage of fluids which may be flammable, toxic, at extreme temperatures, or otherwise harmful.

2.9 Welding & Brazing. Extreme heating of plated products above +450°F (+232°C) such as welding, brazing, baking, etc., where the plating is burned off, may result in the release of deadly gases.

3.0 Installation of Danfoss Couplings.

3.1 Inspection of Product. Prior to installation, ensure that the Danfoss product meets all of the requirements of the system and/or equipment it is to be used on. Ensure you have the correct part number, function test the coupling by connecting it with a mating half. The function test should result in smooth, non-binding operation or premature failure may result.

3.2 Cleanliness. Use end caps and plugs to reduce the risk of system contamination or damage to critical sealing surfaces. Failure to do so may result in leakage of fluids which may be flammable, toxic, at extreme temperatures, or otherwise harmful. Caps and plugs are not a secondary seal unless explicitly noted.

3.3 Location. Place Danfoss couplings in a safe location such as not to expose the user to personal injury (slippage, tripping, falling, etc.) during installation, connection, disconnection and maintenance.

4.0 Product Maintenance. A maintenance schedule should be put in place to ensure that Danfoss couplings are functioning properly. Danfoss is not responsible for product failures resulting from modification or improper maintenance.

4.1 Inspection. Visually inspect to ensure that there is no leakage, cracked components, corrosion build-up, contamination build-up, wear, etc. If any abnormality is encountered, the coupling should be replaced immediately.

Fluid Compatibility

This chart indicates the suitability of various elastomers and metals for use with fluids to be conveyed. It is intended for use with Danfoss couplings and should not be used to determine compatibility for other products. It is intended as a guide only and is not a guarantee. Final selection of the proper seal or material of metal components is further dependent on many factors including pressure, fluid and ambient temperature, concentration, duration of exposure, etc.

How to Use the Chart

- Both the elastomer and the metal must be considered when determining suitability of combination for a coupling.
- Locate the fluid to be conveyed and determine the suitability of the elastomeric and metal components according to the resistance rating shown for each.
- Dimensional and operation specifications for each coupling can be found on the catalog pages.
- Information on seal options for couplings, and how to specify them, are shown in the respective sections of this catalog.
- Be sure to check the table below for maximum operating temperature range of the elastomer desired.
- For further details on the products shown in this catalog, and their applications, consult your Danfoss Sales Representative or Danfoss Technical Support.
- Coupling component materials may differ from body material. Refer to specific catalog pages.

Resistance Rating Key

E = Excellent – Fluid has little or no effect

G = Good – Fluid has minor to moderate effect

C = Conditional – Service conditions should be described to Danfoss for determination of suitability for application

U = Unsatisfactory

The differences between ratings “E” and “G” are relative. Both indicate satisfactory service. Where there is a choice, the materials rated “E” may be expected to give better or longer service than those rated “G”.

The charts below are intended for reference use only. The information in this chart pertains strictly to material compatibility and is not intended to be used as an application guide.

E=Excellent
G=Good
C=Conditional
U=Unsatisfactory

Fluid	Seals								Metal			
	Nitrile (NBR)	Neoprene	FPDM/EPDM	FKM	Steel	Brass	Stainless Steel	Aluminum	Steel	Brass	Stainless Steel	Aluminum
Acetaldehyde	U	C	C	U	G	E	E	E	G	E	E	E
Acetic Acid, 10%	U	U	E	G	U	U	C	C	U	U	C	C
Acetic Acid, Glacial	U	U	C	U	U	U	C	C	U	U	C	C
Acetone	U	U	G	U	E	E	E	E	U	U	E	E
Acetophenone	U	U	E	U	E	E	E	C	U	U	E	E
Acetyl Acetone	U	U	G	U	U	C	C	C	U	U	C	C
Acetyl Chloride	U	U	U	E	C	C	C	U	U	U	C	U
Acetylene (1)	G	U	G	E	E	E	E	E	U	U	C	U
Air, Hot (Up to +160°F)	E	E	E	E	E	E	E	E	U	U	C	U
Air, Hot (161°F – 200°F)	C	G	E	E	E	E	E	E	U	U	C	U
Air, Hot (201°F – 300°F)	U	U	G	E	E	E	E	E	U	U	C	U
Air Wet, below 160°F	E	E	E	E	U	G	E	E	U	U	C	U
Aluminum Chloride, 10% aq	E	E	E	E	U	U	U	U	U	U	C	U
Aluminum Fluoride, 10% aq	E	E	E	E	U	U	U	E	U	U	C	U
Aluminum Nitrate, 10% aq	E	E	E	E	U	U	C	C	U	U	C	U

Fluid	Seals								Metal			
	Nitrile (NBR)	Neoprene	FPDM/EPDM	FKM	Steel	Brass	Stainless Steel	Aluminum	Steel	Brass	Stainless Steel	Aluminum
Aluminum Sulfate, 10% aq	E	E	E	E	U	C	E	C	U	C	E	C
Alums, 10% aq	E	E	E	E	U	C	E	C	U	C	E	C
Ammonia, Cold	E	E	E	U	E	U	E	E	U	U	E	E
Ammonia, Hot	U	G	G	U	E	U	E	E	U	U	E	E
Ammonia, Anhydrous	G	G	E	U	E	U	E	E	U	U	E	E
Ammonia, Aqueous	E	E	E	U	E	U	E	E	U	U	E	E
Ammonium Carbonate, 10% aq	U	E	E	U	C	U	C	C	U	C	E	C
Ammonium Chloride, 10% aq	E	E	E	U	U	U	C	U	U	C	U	U
Ammonium Hydroxide, 10% aq	C	C	E	C	G	U	C	C	U	C	E	C
Ammonium Nitrate, 10% aq	E	G	E	U	G	U	G	G	U	C	E	C
Ammonium Phosphate, 10% aq	E	E	E	-	U	C	G	U	U	C	E	C
Ammonium Sulfate/Sulfide, 10% aq	E	E	E	U	U	U	G	U	U	C	E	C
Amyl Acetate	U	U	G	U	E	E	E	E	U	C	E	C
Amyl Alcohol	G	C	E	G	G	G	E	U	U	C	E	C
Aniline, Aniline Oil	U	U	G	U	E	U	E	G	U	C	E	C

Fluid Compatibility

E=Excellent
G=Good
C=Conditional
U=Unsatisfactory

Fluid	Seals				Metal			
	Nitrile (NBR)	Neoprene	FPDM/EPDM	FKM	Steel	Brass	Stainless Steel	Aluminum
Aniline Dyes	U	G	G	G	U	C	G	C
Asphalt, < 200°F	G	C	U	E	E	G	E	C
IRM 901 Oil	E	E	C	E	E	E	E	E
IRM 902 Oil	E	G	U	E	E	E	E	E
IRM 903 Oil	E	C	U	E	E	E	E	E
Automatic Trans. Fluid	E	C	U	E	E	E	E	E
Barium Chloride, 10% aq	E	E	E	E	U	G	G	G
Barium Hydroxide, 10% aq	E	E	E	E	G	U	G	U
Barium Sulfide, 10% aq	E	E	E	E	C	U	G	U
Benzene, Benzol	U	U	U	E	G	E	E	G
Benzoic Acid	U	U	U	E	U	G	G	G
Benzyl Alcohol	U	G	G	E	E	G	E	G
BioDiesel (<B20)	G	C	U	E				
BioDiesel (>B20)	G	C	U	E				
Black Sulfate Liquor	C	C	C	E	E	C	E	U
Blast Furnace Gas	U	U	U	E	E	C	E	U
Borax, 10% aq	G	G	E	E	E	E	E	G
Boric Acid, 10% aq	G	G	G	E	U	G	C	C
Brine	E	G	E	E	U	G	G	U
Bromine, Dry	U	U	U	E	U	C	U	C
Butane	E	C	U	E	E	E	E	E
Butyl Acetate	U	U	G	U	E	E	E	E
Butyl Alcohol	E	E	G	E	G	G	G	G
Butyl Cellosolve	U	U	G	U	E	E	E	E
Butylene (Butene)	C	U	U	E	E	E	E	E
Butyl Stearate	G	U	U	E	G	G	G	G
Butyraldehyde	U	U	G	U	E	E	E	E
Calcium Acetate, 10% aq	G	G	E	U	G	G	G	C
Calcium Bisulfate, 10% aq	E	E	U	E	U	C	C	U
Calcium Chloride, 10% aq	E	E	E	E	G	G	G	C
Calcium Hydroxide, 10% aq	E	E	E	E	G	G	G	U
Calcium Hypochlorite, 10% aq	U	U	E	E	U	G	C	U
Calcium Nitrate, 10% aq	E	E	E	E	G	G	G	G
Carbitol	G	G	G	G	E	E	E	E
Carbolic Acid (Phenol)	U	U	G	E	U	E	E	-
Carbonic Acid	G	E	E	E	U	C	E	G
Carbon Dioxide, Dry Gas	G	G	E	E	E	E	E	E
Carbon Disulfide	U	U	U	E	G	G	G	E
Carbon Monoxide	G	G	E	E	E	E	E	E
Carbon Tetrachloride	U	U	U	E	U	G	G	U
Castor Oil	E	E	G	E	E	E	E	E
Cellosolve Acetate	U	U	G	U	U	U	E	G
China Wood Oil (Tung Oil)	G	G	U	E	E	G	E	E
Chlorine Gas, Dry	U	U	U	G	C	C	C	C
Chloroacetic Acid	U	U	G	U	U	U	U	U
Chloroacetone	U	U	E	U	G	G	G	U
Chlorobenzene	U	U	U	G	G	G	G	G
Chloroform	U	U	U	E	G	G	G	G
O-Chlorophenol	U	U	U	E	G	G	G	U
Chlosulfonic Acid	U	U	U	U	G	U	G	G
Chrome Plating Solution	U	U	G	E	C	U	U	U

Fluid	Seals				Metal			
	Nitrile (NBR)	Neoprene	FPDM/EPDM	FKM	Steel	Brass	Stainless Steel	Aluminum
Chromic Acid	U	U	C	E	C	U	U	U
Citric Acid	E	E	E	E	C	C	C	C
Coke Oven Gas	U	U	U	E	E	C	E	U
Copper Chloride, 10% aq	E	E	E	E	U	U	U	U
Copper Cyanide, 10% aq	E	E	E	E	E	U	G	U
Copper Sulfate, 10% aq	E	E	E	E	U	C	G	U
Cotton Seed Oil	E	G	C	E	E	E	E	E
Creosote (Coal Tar)	G	C	U	E	E	C	E	E
Crude Oil	E	G	U	E	G	U	G	U
Cyclohexanol	E	G	U	E	E	E	E	C
Cyclohexanone	U	U	G	U	E	E	E	C
Detergent/Water Solution	E	E	E	E	G	E	E	E
Diacetone Alcohol (Acetol)	U	U	E	U	E	E	E	E
Dibenzyl Ether	U	U	G	U	G	G	G	G
Diesel Oil	E	C	U	E	E	E	E	E
Diethylamine	G	G	G	U	E	U	E	-
Diethyl Phthalate (DOP)	U	U	G	G	E	E	E	E
DOT #3 / #4 Brake fluid	C	U	E	U	E	C	E	E
Dowtherm A&E	U	U	U	E	G	U	E	E
Ethyl Alcohol (Ethanol)	E	E	E	E	E	E	E	G
Ethyl Acetate	U	U	G	U	E	E	E	E
Ethyl Benzene	U	U	U	E	E	G	G	G
Ethyl Cellulose	G	G	G	U	E	G	G	G
Ethyl Chloride	U	U	U	E	E	E	E	G
Ethylene Dichloride	U	U	U	G	G	C	G	G
Ethylene Glycol	E	E	E	E	U	G	E	E
Ferric Chloride, 10% aq	E	G	E	E	U	U	U	U
Ferric Nitrate, 10% aq	E	E	E	E	U	U	G	U
Ferric Sulfate, 10% aq	G	G	G	E	U	U	E	U
Formaldehyde	C	C	G	G	E	E	E	G
Formic Acid	C	G	E	U	U	C	C	C
Fuel Oil	E	C	U	E	E	E	E	E
Furfural	C	C	G	U	G	G	G	G
Gallic Acid, Solution	G	G	G	E	U	-	G	C
Gasoline	E	U	U	E	E	E	E	E
Gasohol	G	U	U	E	E	E	E	G
Glycerine/Glycerol	E	E	E	E	E	G	E	E
Green Sulfate Liquor	G	G	E	E	U	U	E	U
Helium (1)	E	E	E	E	E	E	E	E
Heptane	E	G	U	E	E	E	E	E
Hexaldehyde	U	G	G	U	G	G	E	E
Hexane	E	G	U	E	E	E	E	E
Hydraulic Oils, petroleum based	G	C	U	E	E	E	E	E
Ester Blend	E	U	U	E	E	E	E	E
Phos. Ester/Petroleum Blend	U	U	U	C	E	E	E	E
Silicone Oils	E	E	E	E	E	E	E	E
Straight Petroleum Base	E	C	U	E	E	E	E	E
Straight Phosphate Ester	U	U	G	C	E	E	E	E
Water Glycol	E	E	E	E	E	E	E	G
Water Petroleum Emulsion	E	G	U	E	C	E	E	G
Hydrobromic Acid	U	U	E	E	E	U	E	E

Fluid Compatibility

E=Excellent
G=Good
C=Conditional
U=Unsatisfactory

Fluid	Seals				Metal			
	Nitrile (NBR)	Neoprene	FPDM/EPDM	FKM	Steel	Brass	Stainless Steel	Aluminum
Hydrochloric Acid, Cold	U	U	G	E	U	U	U	U
Hydrocyanic Acid	C	C	E	E	E	E	G	E
Hydrofluoric Acid	U	U	C	U	U	U	U	U
Hydrofluorosilic Acid	G	G	E	E	U	U	U	U
Hydrogen	E	E	E	E	E	E	E	E
Hydrogen Peroxide	G	G	G	E	U	U	G	E
Hydrogen Sulfide, Dry	U	G	E	U	E	G	G	G
Isocyanate	U	U	G	E	G	-	G	-
Iso Octane	E	G	U	E	E	E	E	E
Isopropyl Acetate	U	U	G	U	E	-	E	E
Isopropyl Alcohol	G	G	E	E	E	E	E	G
Isopropyl Ether	G	U	U	U	G	G	G	-
JP-4, JP-5	E	U	U	E	E	E	E	E
Kerosene	E	U	U	E	E	E	E	E
Lacquer/Lacquer Solvents	U	U	U	U	E	E	E	E
Lime Sulfur	U	E	E	E	G	U	G	-
Linseed Oil	E	G	U	E	E	E	E	E
LPG	E	G	U	E	E	E	E	E
Magnesium Chloride, 10% aq	E	E	E	E	E	C	C	G
Magnesium Hydroxide, 10% aq	G	G	E	E	E	G	E	G
Magnesium Sulfate, 10% aq	E	E	E	E	E	E	E	E
Maleic Acid	U	U	U	E	E	G	G	G
Maleic Anhydride	U	U	U	E	G	U	E	G
Malic Acid	G	G	U	G	U	-	E	G
Mercuric Chloride	E	E	E	E	U	U	U	U
Mercury	E	E	E	E	E	U	E	U
Methanol	G	G	E	U	G	G	E	C
Methyl Bromide	G	U	U	E	E	E	G	U
Methyl Chloride	U	U	U	E	E	E	E	U
Methyl Butyl Ketone	U	U	E	U	E	E	E	-
Methyl Ethyl Ketone	U	U	E	U	G	G	G	G
Methylene Chloride	U	U	U	G	G	G	G	G
Methyl Isobutyl Ketone	U	U	U	U	G	G	G	G
Methyl Isopropyl Ketone	U	U	U	U	G	G	G	G
Methyl Salicylate	U	U	C	U	E	G	G	E
MIL-L-2104	E	G	U	E	E	E	E	-
MIL-H-5606	E	G	U	E	E	E	E	E
MIL-H-6083	E	E	U	E	E	E	E	-
MIL-L-7808	G	U	U	E	G	G	E	-
MIL-L-23699	G	U	U	E	E	E	E	E
MIL-H-46170	E	G	U	E	E	E	E	-
MIL-H-83282	E	U	U	E	E	E	E	-
Mineral Oils	E	C	U	E	E	E	E	E
Naphtha	C	U	U	E	-	-	-	-
Naphthalene	U	U	U	E	E	G	E	G
Naphthenic Acid	C	U	U	E	-	G	E	G
Natural Gas	E	E	U	E	G	G	G	G
Nickel Acetate, 10% aq	C	C	E	G	G	C	E	G
Nickel Chloride, 10% aq	E	G	E	E	U	U	G	U
Nickel Sulfate, 10% aq	E	E	E	E	U	G	G	U
Nitric Acid, to 10%	U	U	U	E	U	U	E	U

Fluid	Seals				Metal			
	Nitrile (NBR)	Neoprene	FPDM/EPDM	FKM	Steel	Brass	Stainless Steel	Aluminum
Nitric Acid, over 10%	U	U	U	G	U	U	E	C
Nitrobenzene	U	U	U	G	E	G	E	E
Nitrogen	E	E	E	E	E	E	E	E
Octyl Alcohol	E	E	E	E	E	E	E	E
Oleic Acid	U	U	C	G	C	E	G	C
Oleum, fuming sulfuric acid	U	U	U	E	E	E	E	E
Ortho-Dichlorobenzene	U	U	U	E	G	G	G	G
Oxalic Acid, 10% aq	G	G	E	E	U	C	C	C
Oxygen	-	-	E	E	G	G	G	G
Palmitic Acid	E	G	G	E	G	-	E	G
Para-Dichlorobenzene	U	U	U	E	G	G	G	G
Pentane	E	E	U	E	G	G	G	E
Perchloric Acid	E	G	G	E	U	U	U	U
Perchloroethylene	U	U	U	E	C	G	G	G
Petroleum Base Oils	E	G	U	E	E	E	E	E
Phenol (Carbolic Acid)	U	U	G	E	U	E	E	E
Phosphate Ester	U	U	G	C	E	E	E	E
Phosphoric Acid 20%	U	U	G	E	U	E	U	C
Phosphorous Trichloride	U	U	E	E	C	U	C	E
Potassium Acetate, 10% aq	G	G	E	U	C	G	C	U
Potassium Chloride, 10% aq	E	E	E	E	E	C	E	U
Potassium Cyanide, 10% aq	E	E	E	E	C	U	G	U
Potassium Dichromate, 10% aq	E	E	E	E	C	C	C	C
Potassium Hydroxide, to 10%	G	G	E	G	G	G	G	U
Potassium Hydroxide, over 10%	C	C	E	U	G	G	G	U
Potassium Nitrate, 10% aq	E	E	E	E	G	G	E	G
Potassium Sulfate, 10% aq	E	E	E	E	-	-	-	-
Propane (Liquified)	C	G	-	E	E	E	E	E
Propyl Acetate	U	U	G	U	E	-	E	E
Propyl Alcohol	E	E	E	E	E	E	E	E
Propylene	U	U	U	E	E	E	E	E
Rapeseed oil (B100)	G	C	U	E				
Refrigerant R-12	G	E	C	E	E	E	E	E
Refrigerant R-13	G	E	C	E	E	E	E	E
Refrigerant R-22	U	E	C	U	E	E	E	E
Refrigerant R-134a	E	C	G	U	E	E	E	E
Sewage	E	E	E	E	G	G	G	G
Silicone Oils	E	E	E	E	E	E	E	E
Soap (Water Solutions)	E	E	E	E	E	E	E	U
Sodium Acetate, 10% aq	G	G	E	U	E	E	G	E
Sodium Bicarbonate, 10% aq	E	E	E	E	G	G	E	G
Sodium Borate, 10% aq	E	E	E	E	E	E	E	G
Sodium Carbonate, 10% aq	E	E	E	E	E	G	E	U
Sodium Chloride, 10% aq	E	E	E	E	U	C	C	C
Sodium Cyanide, 10% aq	E	E	E	E	E	-	C	U
Sodium Hydroxide, to 10%	U	G	E	E	C	G	C	U
Sodium Hydroxide, over 10%	U	U	G	E	C	C	C	U
Sodium Hypochlorite, 10% aq	C	C	E	C	U	U	U	U
Sodium Metaphosphate, 10% aq	E	E	E	E	E	G	G	U
Sodium Nitrate, 10% aq	G	G	E	-	E	C	E	E
Sodium Perborate, 10% aq	G	G	E	E	C	U	C	U

Seal information

Seal Information for Danfoss Hansen and Gromelle Products

Dash Number	Compound	Max. Operation temperature range
-***	Nitrile (NBR) – 70 Durometer	-25°C +100°C/-13°F +212°F
-115	PTFE	--
-118	Neoprene	-54°C +100°C/-65°F +212°F
-143	FKM	-29°C +204°C/-15°F +400°F
-146	Nitrile (NBR) – 70 Durometer	-25°C +100°C/-13°F +212°F
-192*	EPDM – 75 Durometer	-54°C +149°C/-65°F +300°F
-235†	Kalrez® 4079 – 78 Durometer	-20°C +275°C/-4°F +527°F
-236*	EPDM – 90 Durometer	-54°C +149°C/-65°F +300°F
-242	(Kalrez 6375 – 75 Durometer)	-20°C +275°C/-4°F +527°F
-503	(FFKM - 75 Durometer)	-15°C +275°C/+5°F +527°F
-292	(EPDM- 70 Durometer)	-54°C +149°C/-65°F +300°F

***No Dash Number required for standard seal material.

*-192 and -236 compounds are not compatible with mineral-based greases or oils.

†Kalrez seals available by special quotation.

Flow data information

For each series presented in our Danfoss Hansen quick disconnect catalog, there is a Flow chart.

Please note that the flow rate data is given for an optimal situation. The data may therefore vary depending on the type of adapter used.

On the right is an example of a flow chart (given for the HK series).

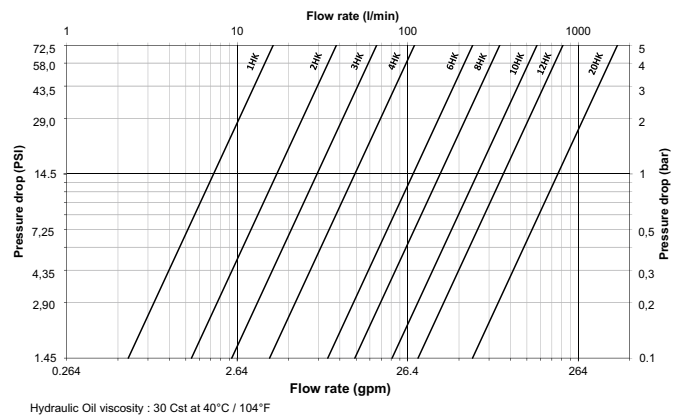

Couplings for fluid transfer and hydraulic applications



Table of Contents

Ball latch poppet

H15000 Series	11
IA Series	13
5600 Series.....	16
H5000 Series	23
FD72/76 Series.....	32
HK Series	33
LL4KP26	42
LL2MS.....	43
HKFR Series.....	44
2HKIG/IL Series.....	45
FD48 Series.....	48

Ball latch straight through

ST Series.....	49
L7000 Series	53

Flat face

FF Series.....	62
FFCUP Series.....	67
MLFF Series.....	69
Multi-FF Series	70
FD49 Series.....	74
FD96 Series.....	76
K8000 Series.....	78
Q9000 Series.....	79
MLDB Series	80
Safety breakaway Series	82

Screw to connect

W36000 Series	84
GA90090 Series.....	87
IP Series.....	89
W6000 Series.....	90
5100 Series.....	96
FD85 Series.....	100
FD86 Series.....	102
W46000 Series	104

H15000 Series

ISO 7241-1 A Interchange

Fluid transfer & Hydraulic application

The H15000 Series is a general purpose industrial interchange coupling that meets the ISO 7241-1 Series A standard. The H15000 Series features a rugged ball latch mechanism with self-sealing poppet valves.



Product Features

- Meets the requirements of ISO 7241-1 Series A
- Designed and manufactured under Article 4.3 of the European Pressure Equipment Directive 2014/68/EU.
- ½" size available in push-pull version (double acting sleeve, bulkhead-mounted)
- Double shut off valves with ball locking
- Standard body material: Zinc trivalent plated steel
- Standard seal material: Buna-N

Physical Characteristics

ISO Size	Coupling Size	Nominal Flow Diameter (mm)	Max. Operating Pressure		Rated Flow**		Fluid Loss ml max
	(in)		(bar)	(psi)	(lpm)	(gpm)	
6.3	¼	5.3	315	4,565	10	2.6	0.35
10	⅜	7.3	315	4,565	20	5.3	1.5
12.5	½	10.2	250	3,625	40	10.6	2.6
20	¾	13	250	3,625	75	19.8	8.5
25	1	16.9	200	2,900	140	37	13

*The ISO size corresponds to the internal diameter of the hose or the external diameter of the rigid tube (as defined in ISO 4397 Standard).

**Indicated values refer to a 1 bar/14.5 psi pressure drop.

Applications & Markets

- Hydraulic Circuits and Equipment
- Hydraulic Fluids
- Agriculture

Flow Data

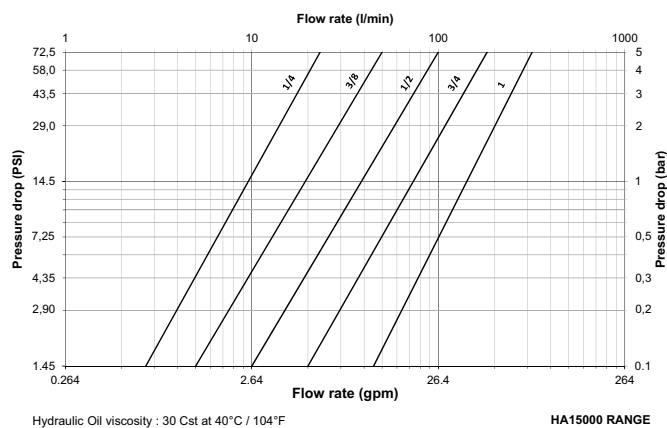

H15000 Series

ISO 7241-1 A Interchange

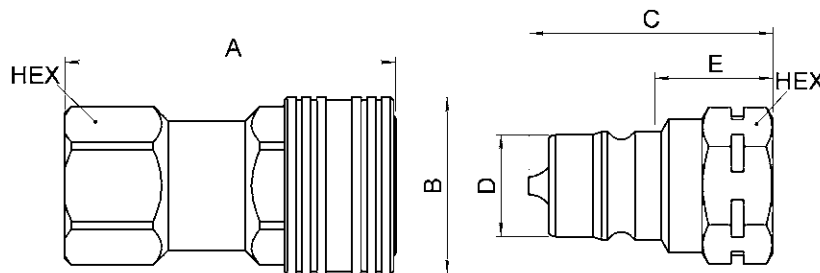

Figure 1

Figure 2

Part Number	Nominal Flow Diameter	ISO	Size	Coupling Type	Thread Size	Fig.	Dimensions			
							A	B	Hex	Weight
	(mm)	(mm)	(in)				(mm)	(mm)	(mm)	(g)
HA1501100	5.3	6.3	¼	Socket/Female	G ¼	1	48	25	19	94
HA1521100	5.3	6.3	¼	Socket/Female	¼ NPT	1	48	25	19	94
HA1502100	7.3	10	⅜	Socket/Female	G ⅜	1	56	30	23	139
HA1522100	7.3	10	⅜	Socket/Female	⅜ NPT	1	56	30	23	139
HA1503100	10.2	12.5	½	Socket/Female	G ½	1	67	38	27	238
HA1503600	10.2	12.5	½	Socket/Female	G ½ push-pull	1	67	38	27	238
HA1523100	10.2	12.5	½	Socket/Female	½ NPT	1	67	38	27	238
HA1504100	13	20	¾	Socket/Female	G ¾	1	83	48	35	484
HA1524100	13	20	¾	Socket/Female	¾ NPT	1	83	48	35	484
HA1505100	16.9	25	1	Socket/Female	G 1	1	98	53	41	670
HA1525100	16.9	25	1	Socket/Female	1 NPT	1	98	53	41	670

Part Number	Nominal Flow Diameter	ISO	Size	Coupling Type	Thread Size	Fig.	Dimensions				
							C	D	E	Hex	Weight
	(mm)	(mm)	(in)				(mm)	(mm)	(mm)	(g)	
HA1501200	5.3	6.3	¼	Plug/Male	G ¼	2	36	11.8	20	19	36
HA1521200	5.3	6.3	¼	Plug/Male	¼ NPT	2	36	11.8	20	19	36
HA1502200	7.3	10	⅜	Plug/Male	G ⅜	2	41.5	17.3	20	23	62
HA1522200	7.3	10	⅜	Plug/Male	⅜ NPT	2	41.5	17.3	20	23	62
HA1503200	10.2	12.5	½	Plug/Male	G ½	2	49	20.5	24	27	88
HA1523200	10.2	12.5	½	Plug/Male	½ NPT	2	49	20.5	24	27	88
HA1504200	13	20	¾	Plug/Male	G ¾	2	61.5	29.1	23	35	194
HA1524200	13	20	¾	Plug/Male	¾ NPT	2	61.5	29.1	27	35	194
HA1505200	16.9	25	1	Plug/Male	G 1	2	71.5	34.3	30	41	306
HA1525200	16.9	25	1	Plug/Male	1 NPT	2	71.5	34.3	30	41	306

To obtain connected length of coupling, add dimensions A (Fig. 1) and E (Fig. 2) together.

Dust Caps and Dust Plugs

Series	Dust Plug	Dust Cap
6.3	HP1511100	HP1511200
10	HP1512100	HP1512200
12.5	HP1513100	HP1513200
20	HP1514100	HP1514200
25	HP1515100	HP1515200



Seal Kit for Servicing Sockets (Female)

Body size	Seal & Back-up Ring Kit*	Qty
(in)	NBR seals & PTFE back-up rings	
1/4	HG 15011 00	50 O-rings + 50 Backup rings
3/8	HG 15021 00	50 O-rings + 50 Backup rings
1/2	HG 05031 00	50 O-rings + 50 Backup rings
3/4	HG 15041 00	50 O-rings + 50 Backup rings
1	HG 15051 00	50 O-rings + 50 Backup rings

*The valve seal is not included in our repair kits

IA Series

ISO 7241-1 A Interchange

Fluid transfer & Hydraulic application



The IA Series meets ISO 7241-1 A Standard requirements and has a push-pull design, which allows the socket to be bulkhead-mounted. This configuration provides automatic connection or disconnection via a simple push or pull of the plug. Our IA Series is available in 1/2", with female or male end connections such as tube fittings, NPT, metric or SAE threads. It is widely used in agriculture and forestry applications.

Product Features

- ISO size: 12.5 mm (1/2")
- Standard body material: Zinc trivalent plated steel
- Wide offering of end connections, among which metric threads designed in accordance with ISO Standard 8434/1
- Standard seal material: NBR
- Optional PVC dust caps and plugs
- Designed and manufactured in accordance with Article 3.3 of the European Pressure Equipment Directive PED 201468/EU
- Meets dimensional requirements of ISO Standard 7241/1 Series A
- Push-to-connect: the push-pull sleeve on the bulkhead-mounted socket provides automatic connection or disconnection via a simple push or pull of the plug. In the event of pull on the hose, the double-action sleeve gives immediate and automatic disconnection

Physical Characteristics

Body Size (in)	ISO Size*	Nominal Flow Diameter (mm)	Max. Operating Pressure bar (psi)	Rated Flow** L/min (gpm)	Fluid Loss ml-cc.
1/2	12.5	6 8 10 10.3	250 3,625	45 11.9	2.6

* The ISO size corresponds to the internal diameter of the hose or the external diameter of the rigid tube (as defined in ISO 4397 Standard).

** Indicated values refer to a 1 bar/14.5 psi pressure drop.

Applications & Markets

- Agriculture
- Forestry Machinery

Flow Data

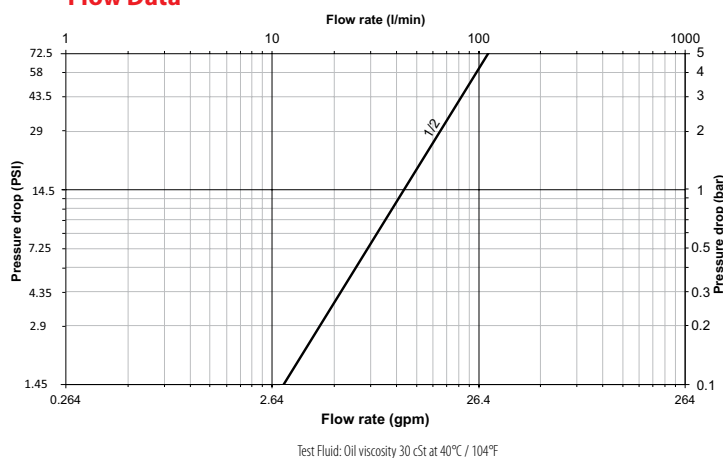

Seal Elastomer Data*

Seal Elastomer	Max. Operation Temperature Range
Buna-N	-20°C +100°C / -4°F +212°F

*For reference only, based on Danfoss recommended temperatures.
Contact Danfoss technical support for further information on fluid compatibility.

IA Series

ISO 7241-1 A Interchange

End Connections

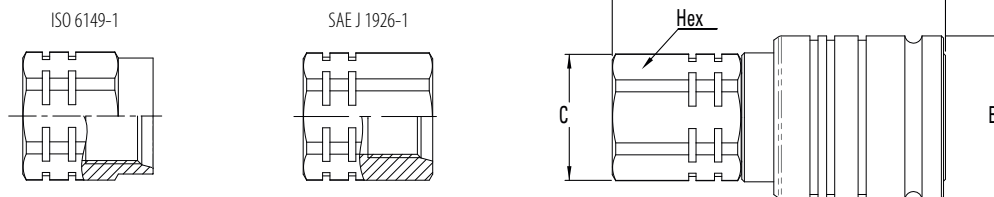

Sockets (Female) with Internal Thread

Part Number	Body Size	ISO Size	Nominal Flow Diameter	Thread Size (Female)				Dimensions								Weight		
				NPT	BSPP	ISO 6149-1	SAE J 1926-1	Fig.	A (in)	B (in)	C (in)	Hex (in)	A (mm)	B (mm)	C (mm)	Hex (mm)	lbs	grams
12IAS37BS				-	3/8-19	-	-	1	2.95	1.50	1.20	1.06	75	38	29.5	27	0.67	305
12IAS37				3/8-18	-	-	-	1	2.95	1.50	1.20	1.06	75	38	29.5	27	0.67	305
12IAS50BS				-	1/2-14	-	-	1	3.07	1.50	1.20	1.06	78	38	29.5	27	0.66	300
12IAS50	1/2	12.5	10.3	1/2-14	-	-	-	1	3.07	1.50	1.20	1.06	78	38	29.5	27	0.67	305
12IAS16FMET				-	-	M16x1.5	-	1	2.95	1.50	1.20	1.06	75	38	29.5	27	0.66	300
12IAS56UN				-	-	-	3/8 18f UNF	1	3.07	1.50	1.20	1.06	78	38	29.5	27	0.71	320
12IAS75UN				-	-	-	3/4 16f UNF	1	3.07	1.50	1.20	1.06	78	38	29.5	27	0.67	305
12IAS87UN				-	-	-	7/8 14f UNF	1	3.19	1.50	1.30	1.18	81	38	33	30	0.74	335

To obtain connected length of coupling add dimensions A (Fig. 1) and K (Fig. 3) or P (Fig. 4) together.

End Connections

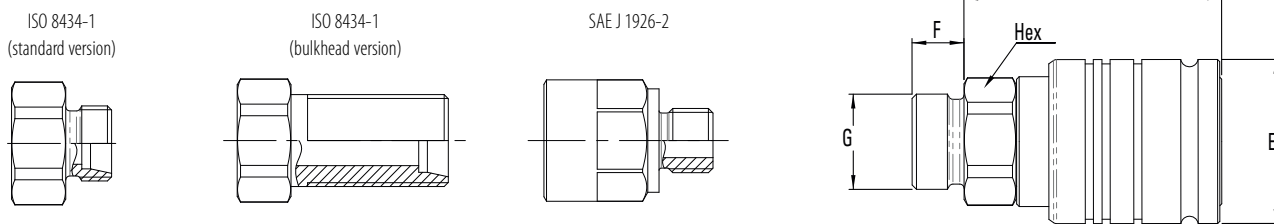

Sockets (Female) with External Thread

Part Number	Body Size	ISO Size	Nominal Flow Diameter	Thread Size (Male)			Dimensions										Weight	
				ISO 8434-1	SAE J 1926-2	Fig.	D (in)	E (in)	F (in)	G (in)	Hex (in)	D (mm)	E (mm)	F (mm)	G (mm)	Hex (mm)	lbs	grams
12IAS56ORM			10.3	-	3/8 18f UNF	2	2.87	1.50	0.47	0.56	0.94	73	38	12	14.2	23.8	0.67	305
12IAS75ORM			10.3	-	3/4 16f UNF	2	2.87	1.50	0.55	0.75	0.94	73	38	14	19	23.8	0.68	310
12IAS8L			6	8L - M14x1.5	-	2	2.44	1.50	0.39	0.55	1.06	62	38	10	14	27	0.61	275
12IAS10L			8	10L - M16x1.5	-	2	2.40	1.50	0.43	0.63	1.06	61	38	11	16	27	0.60	270
12IAS10LBH			8	10L - M16x1.5 Bulkhead	-	2	2.44	1.50	1.38	0.63	1.06	62	38	35	16	27	0.68	310
12IAS12L	1/2	12.5	10	12L - M18x1.5	-	2	2.40	1.50	0.43	0.71	1.06	61	38	11	18	27	0.61	275
12IAS12LBH			10	12L - M18x1.5 Bulkhead	-	2	2.40	1.50	1.42	0.71	1.06	61	38	36	18	27	0.70	316
12IAS12S			8	12S - M20x1.5	-	2	2.40	1.50	0.47	0.79	1.06	61	38	12	20	27	0.62	282
12IAS15L			10.3	15L - M22x1.5	-	2	2.36	1.50	0.47	0.87	1.06	60	38	12	22	27	0.61	275
12IAS15LBH			10.3	15L - M22x1.5 Bulkhead	-	2	2.40	1.50	1.50	0.87	1.06	61	38	38	22	27	0.75	340
12IAS16S			10.3	16S - M24x1.5	-	2	2.36	1.50	0.55	0.94	1.06	60	38	14	24	27	0.62	280

To obtain connected length of coupling add dimensions D (Fig. 2) and K (Fig. 3) or P (Fig. 4) together.

IA Series

ISO 7241-1 A Interchange

End Connections

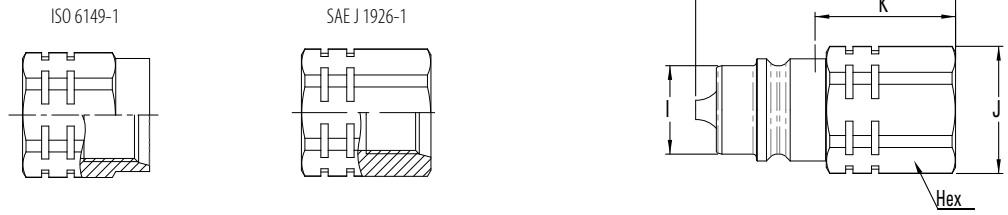

Plugs (Male) with Internal Thread

Part Number	Body Size	ISO Size	Nominal Flow Diameter	Thread Size (Female)				Dimensions										Weight		
				NPT	BSPP	ISO 6149-1	SAE J 1926-1	Fig.	H (in)	I (in)	J (in)	K (in)	Hex (in)	H (mm)	I (mm)	J (mm)	K (mm)	Hex (mm)	lbs	grams
12IAP37BS				-	3/8-19	-	-	3	2.24	0.84	1.20	1.22	1.06	57	20.5	29.5	31	27	0.28	125
12IAP37				3/8-18	-	-	-	3	2.24	0.84	1.20	1.22	1.06	57	20.5	29.5	31	27	0.29	130
12IAP50BS				-	1/2-14	-	-	3	2.36	0.84	1.20	1.34	1.06	60	20.5	29.5	34	27	0.28	125
12IAP50	1/2	12.5	10.3	1/2-14	-	-	-	3	2.36	0.84	1.20	1.34	1.06	60	20.5	29.5	34	27	0.28	125
12IAP16FMET				-	-	M16x1.5	-	3	2.24	0.84	1.20	1.22	1.06	57	20.5	29.5	31	27	0.26	120
12IAP56UN				-	-	-	3/8 18f UNF	3	2.36	0.84	1.20	1.34	1.06	60	20.5	29.5	34	27	0.31	140
12IAP75UN				-	-	-	3/4 16f UNF	3	2.36	0.84	1.20	1.34	1.06	60	20.5	29.5	34	27	0.28	125
12IAP87UN				-	-	-	7/8 14f UNF	3	2.48	0.84	1.30	1.46	1.18	63	20.5	33	37	30	0.34	155

To obtain connected length of coupling add dimensions K (Fig. 3) and A (Fig. 1) or D (Fig. 2) together.

End Connections

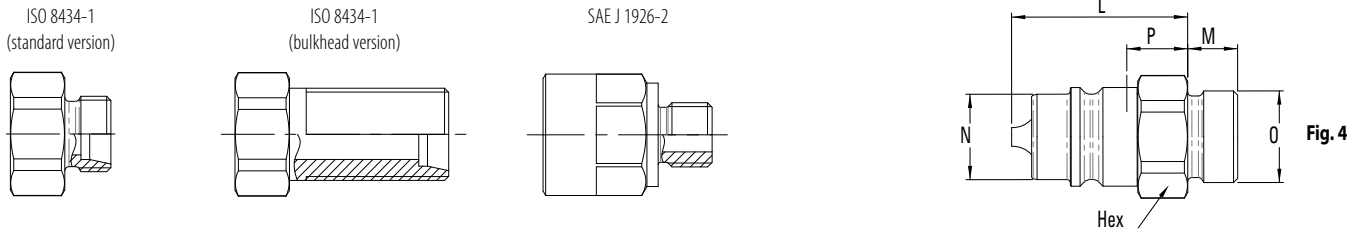

Plugs (Male) with External Thread

Part Number	Body Size	ISO Size	Nominal Flow Diameter	Thread Size (Male)			Dimensions										Weight			
				ISO 8434-1	SAE J 1926-2	Fig.	L (in)	M (in)	N (in)	O (in)	P (in)	Hex (in)	L (mm)	M (mm)	N (mm)	O (mm)	P (mm)	Hex (mm)	lbs	grams
12IAP56ORM			10.3	-	3/8 18f UNF	4	2.20	0.47	0.84	0.56	1.18	0.94	56	12	20.5	14.2	30	23.8	0.28	125
12IAP75ORM			10.3	-	3/4 16f UNF	4	2.20	0.55	0.84	0.75	1.18	0.94	56	14	20.5	19	30	23.8	0.29	130
12IAP8L			6	8L - M14x1.5	-	4	1.75	0.39	0.84	0.55	0.71	1.06	44.5	10	20.5	14	18	27	0.21	95
12IAP10L			8	10L - M16x1.5	-	4	1.71	0.43	0.84	0.63	0.67	1.06	43.5	11	20.5	16	17	27	0.21	95
12IAP10LBH			8	10L - M16x1.5 Bulkhead	-	4	1.75	1.38	0.84	0.63	0.71	1.06	44.5	35	20.5	16	18	27	0.30	135
12IAP12L	1/2	12.5	10	12L - M18x1.5	-	4	1.71	0.43	0.84	0.71	0.67	1.06	43.5	11	20.5	18	17	27	0.21	95
12IAP12LBH			10	12L - M18x1.5 Bulkhead	-	4	1.71	1.42	0.84	0.71	0.67	1.06	43.5	36	20.5	18	17	27	0.30	136
12IAP12S			8	12S - M20x1.5	-	4	1.71	0.47	0.84	0.79	0.67	1.06	43.5	12	20.5	20	17	27	0.22	102
12IAP15L			10.3	15L - M22x1.5	-	4	1.67	0.47	0.84	0.87	0.63	1.06	42.5	12	20.5	22	16	27	0.21	95
12IAP15LBH			10.3	15L - M22x1.5 Bulkhead	-	4	1.71	1.50	0.84	0.87	0.67	1.06	43.5	38	20.5	22	17	27	0.35	160
12IAP16S			10.3	16S - M24x1.5	-	4	1.67	0.55	0.84	0.94	0.63	1.06	42.5	14	20.5	24	16	27	0.22	100

To obtain connected length of coupling add dimensions P (Fig. 4) and A (Fig. 1) or D (Fig. 2) together.

Dust Plugs and Dust Caps

Body Size	Socket Dust Plug Part Number	Plug Dust Cap Part Number
(in)	Plastic	Plastic
1/2	HP1513100	HP1513200



5600 Series (Carbon Steel)

ISO 7241-1 A Interchange

Fluid transfer & Hydraulic application

Danfoss Hansen 5600 Series features a rugged ball latch mechanism with self-sealing poppet valves in a wide array of port configurations and multiple valved and non-valved configurations.



Product Features

- Meets dimensional requirements to ISO standard 7241-1 Series A
- Self-sealing poppet valve provides excellent high and low pressure sealing
- Streamlined valving provides minimum pressure drop
- Standard seal materials: Buna-N, EPDM and FKM
- Standard body material: High resistance carbon steel with zinc trivalent plating (Brass poppet guide in -04 size)

Physical Characteristics

Body Size (in)	Max. Operating Pressure		Min. Burst Pressure Connected		Vacuum Connected Only	Rated Flow		Air Inclusion	Fluid Loss
	(bar)	(psi)	(bar)	(psi)	(in./Hg)	(lpm)	(gpm)	cc. max.	cc.max.
1/4	350	5,000	1,050	15,000	28	4	1	0.50	0.50
3/8	280	4,000	840	12,000	28	23	6	1.5	1.3
5/8	280	4,000	840	12,000	28	45	12	2.8	2.8
3/4	280	4,000	840	12,000	28	106	28	10.0	8.2
1	280	4,000	840	12,000	28	189	50	14.2	14.2

Applications & Markets

- Hydraulic fluid transfer
- Agricultural equipment
- Construction equipment
- Dump, snow plow and maintenance vehicles
- In-plant manufacturing

Flow Data

Pressure Drop Versus Flow Graph

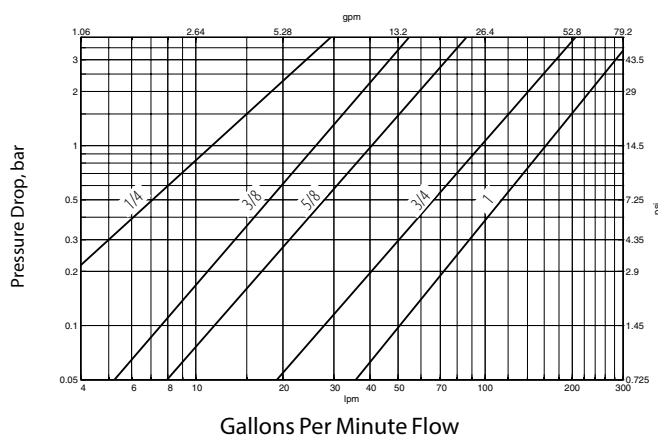

Test Fluid: MIL-H-5606 Oil at 100°F

5600 Series (Carbon Steel)

ISO 7241-1 A Interchange

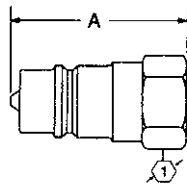

Figure 1

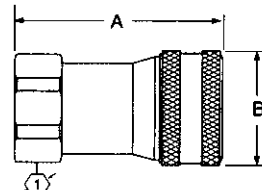

Figure 2

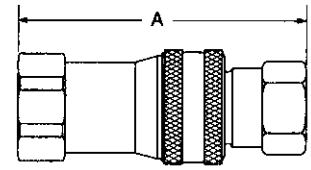

Figure 3

Dimensions (Female NPT, Valved)

Part Number Buna-N	FKM	Coupling EPDM	Body Type	Port Size	Size	Thread	Type	Fig.	Dimensions				Hex ^①			
									A		B					
5602-2-4S	FD56-1062-02-04	5644-2-4S	Plug/Male	1/4	1/8	1/8-27	Female NPT	1	31.5	(1.24)	-	-	14.2	(.56)		
5601-2-4S	FD56-1064-02-04	5643-2-4S	Socket/Female	1/4	1/8	1/8-27	Female NPT	2	46	(1.81)	27.4	(1.08)	22.4	(.88)		
5600-2-4S	FD56-1065-02-04	5642-2-4S	Complete	1/4	1/8	1/8-27	Female NPT	3	61.5	(2.42)	-	-	-	-		
5602-4-4S	FD56-1062-04-04	5644-4-4S	Plug/Male	1/4	1/4	1/4-18	Female NPT	1	33.3	(1.31)	-	-	19.1	(.75)		
5601-4-4S	FD56-1064-04-04	5643-4-4S	Socket/Female	1/4	1/4	1/4-18	Female NPT	2	46	(1.81)	27.4	(1.08)	22.4	(.88)		
5600-4-4S	FD56-1065-04-04	5642-4-4S	Complete	1/4	1/4	1/4-18	Female NPT	3	63.2	(2.49)	-	-	-	-		
5602-6-6S	FD56-1062-06-06	5644-6-6S	Plug/Male	3/8	3/8	3/8-18	Female NPT	1	37.3	(1.47)	-	-	22.4	(.88)		
5601-6-6S	FD56-1064-06-06	5643-6-6S	Socket/Female	3/8	3/8	3/8-18	Female NPT	2	54.6	(2.15)	31.2	(1.23)	25.4	(1.00)		
5600-6-6S	FD56-1065-06-06	5642-6-6S	Complete	3/8	3/8	3/8-18	Female NPT	3	71.1	(2.80)	-	-	-	-		
5602-8-10S	FD56-1062-08-10	5644-8-10S	Plug/Male	5/8	1/2	1/2-14	Female NPT	1	51.3	(2.02)	-	-	26.9	(1.06)		
5601-8-10S	FD56-1064-08-10	5643-8-10S	Socket/Female	5/8	1/2	1/2-14	Female NPT	2	66.3	(2.61)	38.1	(1.50)	30.2	(1.19)		
5600-8-10S	FD56-1065-08-10	5642-8-10S	Complete	5/8	1/2	1/2-14	Female NPT	3	96	(3.78)	-	-	-	-		
5602-12-10S	FD56-1062-12-10	5644-12-10S	Plug/Male	5/8	3/4	3/4-14	Female NPT	1	54.9	(2.16)	-	-	35.1	(1.38)		
5601-12-10S	FD56-1064-12-10	5643-12-10S	Socket/Female	5/8	3/4	3/4-14	Female NPT	2	66.3	(2.61)	38.1	(1.50)	33.3	(1.31)		
5600-12-10S	FD56-1065-12-10	5642-12-10S	Complete	5/8	3/4	3/4-14	Female NPT	3	103.1	(4.06)	-	-	-	-		
5602-12-12S	FD56-1062-12-12	5644-12-12S	Plug/Male	3/4	3/4	3/4-14	Female NPT	1	64.8	(2.55)	-	-	35.1	(1.38)		
5601-12-12S	FD56-1064-12-12	5643-12-12S	Socket/Female	3/4	3/4	3/4-14	Female NPT	2	82.6	(3.25)	46	(1.81)	38.1	(1.50)		
5600-12-12S	FD56-1065-12-12	5642-12-12S	Complete	3/4	3/4	3/4-14	Female NPT	3	115.8	(4.56)	-	-	-	-		
5602-16-16S	FD56-1062-16-16	5644-16-16S	Plug/Male	1	1	1-11 1/2	Female NPT	1	78.7	(3.10)	-	-	41.1	(1.62)		
5601-16-16S	FD56-1064-16-16	5643-16-16S	Socket/Female	1	1	1-11 1/2	Female NPT	2	97	(3.82)	53.3	(2.10)	42.9	(1.69)		
5600-16-16S	FD56-1065-16-16	5642-16-16S	Complete	1	1	1-11 1/2	Female NPT	3	123.4	(4.86)	-	-	-	-		

Dimensions (Female NPT, Valved with Sleeve Lock)

Part Number Buna-N	Coupling Type	Body Size	Port Size	Thread	Type	Fig.	Dimensions				Hex ^①			
							A		B					
FD56-1239-08-10	Socket/Female	5/8	1/2	1/2-14	Female NPT	2	66.3	(2.61)	38.1	(1.50)	30.2	(1.19)		
FD56-1239-12-12	Socket/Female	3/4	3/4	3/4-14	Female NPT	2	82.6	(3.25)	46.7	(1.84)	38.1	(1.50)		
FD56-1239-16-16	Socket/Female	1	1	1-11 1/2	Female NPT	2	97.0	(3.82)	54.1	(2.13)	42.9	(1.69)		

5600 Series (Carbon Steel)

ISO 7241-1 A Interchange

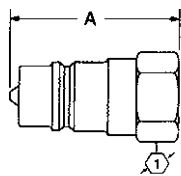

Figure 1

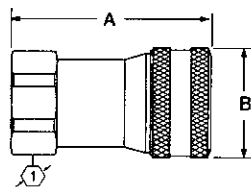

Figure 2

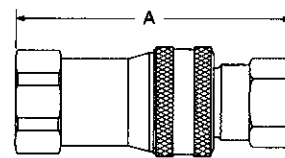

Figure 3

Dimensions (Female NPT, Non-Valved)

Part Number Buna-N	FKM	EPDM	Coupling Type	Body Size	Port Size	Thread	Type	Fig.	Dimensions					
									A		B		Hex ①	
								mm (in)		mm (in)		mm (in)		
FD56-1037-04-04	FD56-1037-04-04	FD56-1037-04-04	Plug/Male*	1/4	1/4	1/4-18	Female NPT	1	31.5	(1.24)	-	-	19.1	(.75)
FD56-1225-04-04	FD56-1207-04-04	FD56-1204-04-04	Socket/Female	1/4	1/4	1/4-18	Female NPT	2	46.0	(1.81)	27.4	(1.08)	22.4	(.88)
FD56-1226-04-04	FD56-1208-04-04	FD56-1205-04-04	Complete*	1/4	1/4	1/4-18	Female NPT	3	63.2	(2.49)	-	-	-	-
FD56-1037-06-06	FD56-1037-06-06	FD56-1037-06-06	Plug/Male*	3/8	3/8	3/8-18	Female NPT	1	35.6	(1.40)	-	-	22.4	(.88)
FD56-1225-06-06	FD56-1207-06-06	FD56-1204-06-06	Socket/Female	3/8	3/8	3/8-18	Female NPT	2	54.6	(2.15)	31.2	(1.23)	25.4	(1.00)
FD56-1226-06-06	FD56-1208-06-06	FD56-1205-06-06	Complete*	3/8	3/8	3/8-18	Female NPT	3	71.1	(2.80)	-	-	-	-
FD56-1037-08-10	FD56-1037-08-10	FD56-1037-08-10	Plug/Male*	5/8	1/2	1/2-14	Female NPT	1	48	(1.89)	-	-	26.9	(1.06)
FD56-1225-08-10	FD56-1207-08-10	FD56-1204-08-10	Socket/Female	5/8	1/2	1/2-14	Female NPT	2	66.3	(2.61)	38.1	(1.50)	30.2	(1.19)
FD56-1226-08-10	FD56-1208-08-10	FD56-1205-08-10	Complete*	5/8	1/2	1/2-14	Female NPT	3	96	(3.78)	-	-	-	-
FD56-1037-12-12	FD56-1037-12-12	FD56-1037-12-12	Plug/Male*	3/4	3/4	3/4-14	Female NPT	1	57.9	(2.28)	-	-	-	-
FD56-1225-12-12	FD56-1207-12-12	FD56-1204-12-12	Socket/Female	3/4	3/4	3/4-14	Female NPT	2	82.6	(3.25)	46.0	(1.81)	38.1	(1.50)
FD56-1226-12-12	FD56-1208-12-12	FD56-1205-12-12	Complete*	3/4	3/4	3/4-14	Female NPT	3	113.3	(4.46)	-	-	-	-
FD56-1037-16-16	FD56-1037-16-16	FD56-1037-16-16	Plug/Male*	1	1	1-11 1/2	Female NPT	1	70.4	(2.77)	-	-	41.1	(1.62)
FD56-1225-16-16	FD56-1207-16-16	FD56-1204-16-16	Socket/Female	1	1	1-11 1/2	Female NPT	2	97	(3.82)	53.3	(2.10)	42.9	(1.69)
FD56-1226-16-16	FD56-1208-16-16	FD56-1205-16-16	Complete*	1	1	1-11 1/2	Female NPT	3	140.7	(5.54)	-	-	-	-

Note: Will not operate with valved coupling halves; no valve actuator. *Male halves contain no seals.

Dimensions (Female NPT, Pusher-Style Valving)

Part Number Buna-N	FKM	EPDM	Coupling Type	Body Size	Port Size	Thread	Type	Fig.	Dimensions					
									A		B		Hex ①	
								mm (in)		mm (in)		mm (in)		
FD56-1125-04-04	FD56-1125-04-04	FD56-1125-04-04	Plug/Male	1/4	1/4	1/4-18	Female NPT	1	31.5	(1.24)	-	-	19	(.75)
FD56-1123-04-04	FD56-1201-04-04	FD56-1196-04-04	Socket/Female	1/4	1/4	1/4-18	Female NPT	2	46	(1.81)	27.4	(1.08)	22.4	(.88)
FD56-1125-06-06	FD56-1125-06-06	FD56-1125-06-06	Plug/Male	3/8	3/8	3/8-18	Female NPT	1	35.6	(1.40)	-	-	22.4	(.88)
FD56-1123-06-06	FD56-1201-06-06	FD56-1196-06-06	Socket/Female	3/8	3/8	3/8-18	Female NPT	2	54.6	(2.15)	31.2	(1.23)	25.4	(1.00)
FD56-1125-08-10	FD56-1125-08-10	FD56-1125-08-10	Plug/Male	5/8	1/2	1/2-14	Female NPT	1	48	(1.89)	-	-	26.9	(1.06)
FD56-1123-08-10	FD56-1201-08-10	FD56-1196-08-10	Socket/Female	5/8	1/2	1/2-14	Female NPT	2	66.3	(2.61)	38.1	(1.50)	30.2	(1.19)
FD56-1125-12-12	FD56-1125-12-12	FD56-1125-12-12	Plug/Male	3/4	3/4	3/4-14	Female NPT	1	57.9	(2.28)	-	-	35.1	(1.38)
FD56-1123-12-12	FD56-1201-12-12	FD56-1196-12-12	Socket/Female	3/4	3/4	3/4-14	Female NPT	2	82.6	(3.25)	46	(1.81)	38.1	(1.50)
FD56-1125-16-16	FD56-1125-16-16	FD56-1125-16-16	Plug/Male	1	1	1-11 1/2	Female NPT	1	70.4	(2.77)	-	-	41.1	(1.62)
FD56-1123-16-16	FD56-1201-16-16	FD56-1196-16-16	Socket/Female	1	1	1-11 1/2	Female NPT	2	97	(3.82)	53.3	(2.10)	42.9	(1.69)

Note: Incorporates a pusher device to open mating valved coupling halves.

Dimensions (Plug/Male Half, Female BSP/Valved)

Part Number Buna-N	Body Size	Thread	Fig.	Dimensions A		B	Hex ①		
				(in)	mm		(in)	mm	
G5623-4-4	1/4	G 1/4	1	(1.34)	34	-	-	(0.75)	19.0
G5623-6-6	3/8	G 3/8	1	(1.50)	38	-	-	(0.91)	23.0
G5623-8-10	5/8	G 1/2	1	(1.73)	44	-	-	(1.06)	27.0
G5623-12-12	3/4	G 3/4	1	(2.17)	55	-	-	(1.38)	35.0
G5623-16-16	1	G 1	1	(2.52)	64	-	-	(1.61)	41.0

5600 Series (Carbon Steel)

ISO 7241-1 A Interchange

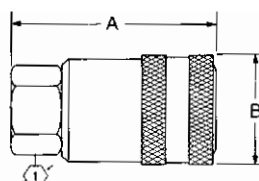

Figure 4

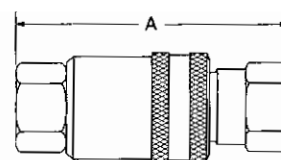

Figure 5

Dimensions (Socket/Female Half, Female BSP/Valved)

Part Number Buna-N	Body Size	Thread	Fig.	Dimensions A		B		Hex ①	
				(in)	mm	(in)	mm	(in)	mm
G5622-4-4	1/4	G 1/4	2	(1.89)	48	(1.04)	26.3	(0.87)	22.0
G5622-6-6	3/8	G 3/8	2	(2.20)	56	(1.18)	30	(1.06)	27.0
G5622-8-10	5/8	G 1/2	2	(2.60)	66	(1.51)	38.3	(1.06)	27.0
G5622-12-12	3/4	G 3/4	2	(3.25)	82.5	(1.89)	48	(1.57)	40.0
G5622-16-16	1	G 1	2	(3.86)	98	(2.09)	53	(1.97)	50.0

Dimensions (Female NPT, Connect Under Pressure Style)

Part Number Buna-N	FKM	EPDM	Coupling Type	Coupling Size	Body Size	Port Thread	Type	Fig.	Dimensions					
									A	B	Hex ①			
									mm	(in)	mm	(in)	mm	(in)
5602-8-10S	FD56-1062-08-10	5644-8-10S	Plug/Male	5/8	1/2	1/2-14	Female NPT Valved	1	51.3	(2.02)	-	-	26.9	(1.06)
5651-8-10S	FD56-1070-08-10	565007-8-10S	Socket/Female	5/8	1/2	1/2-14	Female NPT	4	73.2	(2.88)	38.1	(1.50)	26.9	(1.06)
5650-8-10S	FD56-1071-08-10	565006-8-10S	Complete	5/8	1/2	1/2-14	Female NPT	5	98.8	(3.89)	-	-	-	-
5602-12-10S	FD56-1062-12-10	5644-12-10S	Plug/Male	5/8	3/4	3/4-14	Female NPT Valved	1	54.9	(2.16)	-	-	35.1	(1.38)
5651-12-10S	FD56-1070-12-10	565007-12-10S	Socket/Female	5/8	3/4	3/4-14	Female NPT	4	83.8	(3.30)	38.1	(1.50)	31.8	(1.25)
5650-12-10S	FD56-1071-12-10	565006-12-10S	Complete	5/8	3/4	3/4-14	Female NPT	5	113	(4.45)	-	-	-	-

Dimensions (Female, SAE O-Ring Valved)

Part Number Buna-N	FKM	EPDM	Coupling Type	Body Size	Port Size	Thread	Type	Fig.	Dimensions					
									A	B	Hex ①			
									mm	(in)	mm	(in)	mm	(in)
5610-4-4S	FD56-1072-04-04	560078-4-4S	Plug/Male	1/4	7/16	7/16-20	Female SAE O-Ring	1	32.5	(1.28)	-	-	15.7	(.62)
5608-4-4S	FD56-1074-04-04	FD56-1012-04-04S	Socket/Female	1/4	7/16	7/16-20	Female SAE O-Ring	2	46	(1.81)	27.4	(1.08)	22.4	(.88)
5606-4-4S	FD56-1075-04-04	FD56-1009-04-04S	Complete	1/4	7/16	7/16-20	Female SAE O-Ring	3	64.3	(2.53)	-	-	-	-
5610-6-6S	FD56-1072-06-06	560078-6-6S	Plug/Male	3/8	9/16	9/16-18	Female SAE O-Ring	1	38.1	(1.50)	-	-	22.4	(.88)
5608-6-6S	FD56-1074-06-06	FD56-1012-06-06S	Socket/Female	3/8	9/16	9/16-18	Female SAE O-Ring	2	54.6	(2.15)	31.2	(1.23)	25.4	(1.00)
5606-6-6S	FD56-1075-06-06	FD56-1009-06-06S	Complete	3/8	9/16	9/16-18	Female SAE O-Ring	3	72.1	(2.84)	-	-	-	-
5610-8-10S	FD56-1072-08-10	560078-8-10S	Plug/Male	5/8	3/4	3/4-16	Female SAE O-Ring	1	51.6	(2.03)	-	-	26.9	(1.06)
5608-8-10S	FD56-1074-08-10	FD56-1012-08-10S	Socket/Female	5/8	3/4	3/4-16	Female SAE O-Ring	2	66.3	(2.61)	38.1	(1.50)	30.2	(1.19)
5606-8-10S	FD56-1075-08-10	FD56-1009-08-10S	Complete	5/8	3/4	3/4-16	Female SAE O-Ring	3	96	(3.78)	-	-	-	-
5610-10-10S	FD56-1072-10-10	560078-10-10S	Plug/Male	5/8	7/8	7/8-14	Female SAE O-Ring	1	52.8	(2.08)	-	-	28.4	(1.12)
5608-10-10S	FD56-1074-10-10	FD56-1012-10-10S	Socket/Female	5/8	7/8	7/8-14	Female SAE O-Ring	2	66.3	(2.61)	38.1	(1.50)	30.2	(1.19)
5606-10-10S	FD56-1075-10-10	FD56-1009-10-10S	Complete	5/8	7/8	7/8-14	Female SAE O-Ring	3	98.6	(3.88)	-	-	-	-
5610-12-12S	FD56-1072-12-12	560078-12-12S	Plug/Male	3/4	1 1/16	1 1/16-12	Female SAE O-Ring	1	64.8	(2.55)	-	-	35.1	(1.38)
5608-12-12S	FD56-1074-12-12	FD56-1012-12-12S	Socket/Female	3/4	1 1/16	1 1/16-12	Female SAE O-Ring	2	82.6	(3.25)	46	(1.81)	38.1	(1.50)
5606-12-12S	FD56-1075-12-12	FD56-1009-12-12S	Complete	3/4	1 1/16	1 1/16-12	Female SAE O-Ring	3	115.8	(4.56)	-	-	-	-
5610-16-16S	FD56-1072-16-16	560078-16-16S	Plug/Male	1	1 5/16	1 5/16-12	Female SAE O-Ring	1	78.7	(3.10)	-	-	41.1	(1.62)
5608-16-16S	FD56-1074-16-16	FD56-1012-16-16S	Socket/Female	1	1 5/16	1 5/16-12	Female SAE O-Ring	2	97.3	(3.83)	53.3	(2.10)	42.9	(1.69)
5606-16-16S	FD56-1075-16-16	FD56-1009-16-16S	Complete	1	1 5/16	1 5/16-12	Female SAE O-Ring	3	140.7	(5.54)	-	-	-	-

Dimensions (Female SAE O-Ring, Valved with Sleeve Lock)

Part Number Buna-N	FKM	EPDM	Coupling Type	Body Size	Port Size	Thread	Type	Fig.	Dimensions					
									A	B	Hex ①			
									mm	(in)	mm	(in)	mm	(in)
FD56-1270-06-06	-	-	Socket/Female	3/8	9/16	9/16-18	Female SAE O-Ring	3	54.6	(2.15)	31.8	(1.23)	25.4	(1.00)
FD56-1270-08-10	-	-	Socket/Female	5/8	3/4	3/4-16	Female SAE O-Ring	3	66.3	(2.61)	38.1	(1.50)	30.2	(1.19)
FD56-1270-12-12	-	-	Socket/Female	3/4	1 1/16	1 1/16-12	Female SAE O-Ring	3	82.6	(3.25)	46.7	(1.81)	38.1	(1.50)
FD56-1270-16-16	-	-	Socket/Female	1	1 5/16	1 5/16-12	Female SAE O-Ring	3	97.0	(3.82)	54.1	(2.10)	42.9	(1.69)

5600 Series (Carbon Steel)

ISO 7241-1 A Interchange

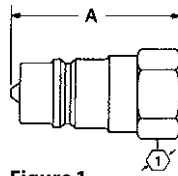

Figure 1

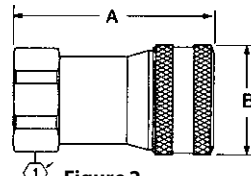

Figure 2

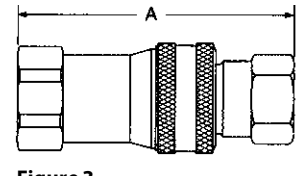

Figure 3

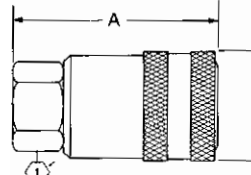

Figure 4

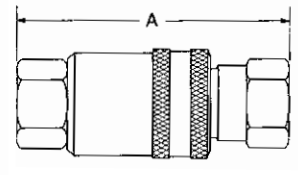

Figure 5

Dimensions (Female, SAE O-Ring Non-Valved)

Part Number	Buna-N	FKM	EPDM	Coupling Type	Body Size	Port Size	Thread	Type	Fig.	Dimensions					
										A	B	Hex ①			
										mm	(in)	mm	(in)	mm	(in)
5620-8-10S	FD56-1221-08-10	FD56-1221-08-10	FD56-1221-08-10	Plug/Male	5/8	3/4	3/4-16	Female SAE O-Ring	1	48.0	(1.89)	25.9	(1.02)	26.9	(1.06)
5691-8-10S	FD56-1233-08-10	FD56-1209-08-10	FD56-1209-08-10	Socket/Female	5/8	3/4	3/4-16	Female SAE O-Ring	2	66.3	(2.61)	38.1	(1.50)	30.2	(1.19)
5690-8-10S	FD56-1234-08-10	FD56-1210-08-10	FD56-1210-08-10	Complete	5/8	3/4	3/4-16	Female SAE O-Ring	3	96.0	(3.78)	-	-	-	-
5620-12-12S	FD56-1221-12-12	FD56-1221-12-12	FD56-1221-12-12	Plug/Male	3/4	1 1/16	1 1/16-12	Female SAE O-Ring	1	57.9	(2.28)	30.7	(1.21)	35.1	(1.38)
5691-12-12S	FD56-1233-12-12	FD56-1209-12-12	FD56-1209-12-12	Socket/Female	3/4	1 1/16	1 1/16-12	Female SAE O-Ring	2	82.6	(3.25)	46.0	(1.81)	38.1	(1.50)
5690-12-12S	FD56-1234-12-12	FD56-1210-12-12	FD56-1210-12-12	Complete	3/4	1 1/16	1 1/16-12	Female SAE O-Ring	3	115.8	(4.56)	-	-	-	-
5620-16-16S	FD56-1221-16-16	FD56-1221-16-16	FD56-1221-16-16	Plug/Male	1	1 5/16	1 5/16-12	Female SAE O-Ring	1	70.4	(2.77)	36.8	(1.45)	41.1	(1.62)
5691-16-16S	FD56-1233-16-16	FD56-1209-16-16	FD56-1209-16-16	Socket/Female	1	1 5/16	1 5/16-12	Female SAE O-Ring	2	103.9	(4.09)	54.6	(2.15)	47.8	(1.88)
5690-16-16S	FD56-1234-16-16	FD56-1210-16-16	FD56-1210-16-16	Complete	1	1 5/16	1 5/16-12	Female SAE O-Ring	3	140.0	(5.51)	-	-	-	-

Dust Caps

Part Number	Body Size (in)
5657-4	1/4
5657-6	3/8
5657-10	5/8
5657-12	3/4
5657-16	1



Dust Cap

Break Away Frame

Part Number	Body Size (in)
5603	5/8



Break Away Frame

Dust Plugs

Part Number	Body Size (in)
5659-4	1/4
5659-6	3/8
5659-10	5/8
5659-12	3/4
5659-16	1



Dust Plug

5600 Series (Stainless Steel)

ISO 7241-1 A Interchange

Fluid transfer & Hydraulic application

The Danfoss Hansen 5600 Series is a rugged poppet style ball locking quick disconnect coupling. As the original manufacturer of the ISO 7241-1 A style coupling, Danfoss has reinvented this quick disconnect coupling series to meet your application needs by offering a new stainless steel construction.



Product Features

- Self-sealing poppet valve provides excellent high and low pressure sealing
- Stainless steel construction offers excellent corrosion resistance in tough environments
- Standard body material: 303 stainless steel
- Standard body material: Nitrile (NBR). EPDM and FKM seals are available upon request
- Available sizes include: 5/8", 3/4", 1"*
- Female NPTF thread ends

*Additional sizes are available upon request.

Physical Characteristics

Body Size (in)	Max. Operating Pressure Connected		Min. Burst Pressure		Rated Flow		Air Inclusion	Fluid Loss
	(bar)	(psi)	(bar)	(psi)	(lpm)	(gpm)	cc. max.	cc.max.
5/8	207	3,000	621	9,000	45	12	2.8	2.8
3/4	207	3,000	621	9,000	106	28	10	8.2
1	207	3,000	621	9,000	189	50	14.2	14.2

Applications & Markets

- Hydraulic and Fluid Transfer
- Agricultural Equipment
- Construction Equipment
- Steel Mills
- Plant Manufacturing and Processing Equipment
- Dump, Snow Plow, and Maintenance Vehicles

Flow Data

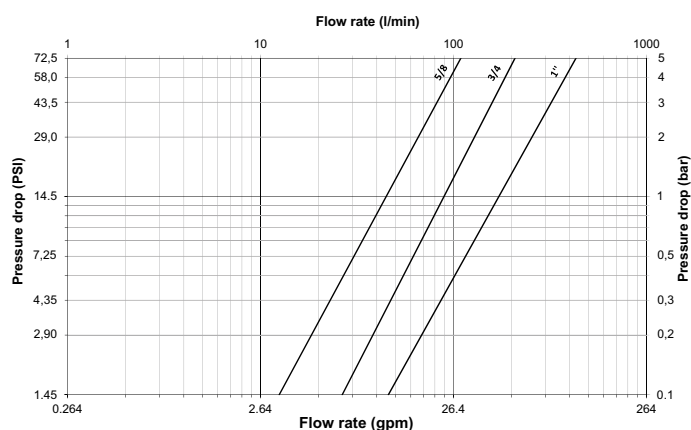

Hydraulic Oil viscosity : 30 Cst at 40°C / 104°F

5600 Series

5600 Series (Stainless Steel)

ISO 7241-1 A Interchange

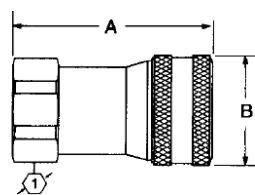

Figure 1

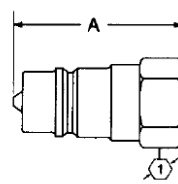

Figure 2

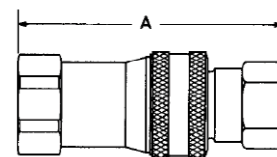

Figure 3

Female (socket)

Part Number	Coupling Type	Body Size	Thread	Fig.	Dimensions			A	B	Hex
					A	B	Hex			
					(in)	(in)	(in)	(mm)	(mm)	(mm)
560024-8-10	Socket/Female	5/8	1/2-14 NPTF	1	2.61	1.5	1.19	66.3	38.1	30.2
560024-12-12	Socket/Female	3/4	3/4-14 NPTF	1	3.25	1.81	1.50	82.6	46.0	38.1
560024-16-16	Socket/Female	1	1 1/2-14 NPTF	1	3.82	2.1	1.69	97.0	53.3	42.9

Plugs (Male)

Part Number	Coupling Type	Body Size	Thread	Fig.	Dimensions			A	B	Hex
					A	B	Hex			
					(in)	(in)	(in)	(mm)	(mm)	(mm)
560049-8-10	Plug/Male	5/8	1/2-14 NPTF	2	2.02	–	1.06	51.3	–	26.9
560049-12-12	Plug/Male	3/4	3/4-14 NPTF	2	2.55	–	1.38	64.8	–	35.1
560049-16-16	Plug/Male	1	1 1/2-14 NPTF	2	3.1	–	1.62	78.7	–	41.1

Complete Sets*

Part Number	Coupling Type	Body Size	Thread	Fig.	Dimensions	
					A	A
					(in)	(mm)
FD56-1001-08-10	Complete	5/8	1/2-14 NPTF	3	3.78	96.0
FD56-1001-12-12	Complete	3/4	3/4-14 NPTF	3	4.56	115.8
FD56-1001-16-16	Complete	1	1 1/2-14 NPTF	3	4.86	123.4

*Includes one socket/female and one plug/male half in the outlined size.

H5000 Series (Steel)

Fluid transfer & Hydraulic application



Danfoss' H5000 Series steel quick disconnect coupling is a pull to connect double shut-off coupling. Featuring the original profile, it remains as the series users prefer when it comes to severe hydraulic applications such as high pressure, pressure impulses, heavy mechanical loads and frequent connection and disconnection cycles. The unique sleeve lock option offers a reliable solution and benefit to the end user when safety is a concern.

Product Features

- Proprietary profile
 - Pull-to-connect with double shut-off valving
 - Ball-locking
 - Optional safety sleeve lock prevents accidental disconnections
 - Optional dust caps and plugs (made of anodized aluminum)
 - Pressure performance
 - Standard body material: Zinc trivalent steel
 - Standard seal material: NBR, FKM, EPDM
 - The heat treatment of the plug and use of high strength steel for the socket sleeve provide superior mechanical and hydraulic performance
- The design of the valve gives the coupling increased robustness when disconnected.

European Pressure Equipment Directive

Couplings with nominal diameters up to and including 25 mm are designed and manufactured under Article 4.3 of the European Pressure Equipment Directive 2014/68/EU. Couplings with nominal diameters greater than 25 mm are designed and manufactured in accordance with the stipulations of Module A of the European Pressure Equipment Directive 2014/68/EU. They should not be used to convey unstable gases.

Group 1 = Hazardous media / Group 2 = Other media

Applications & Markets

- Automobile
- Agriculture
- Construction
- Oil and Gas
- Railway
- Aeronautics
- Food Processing
- Iron and Steel Industry
- Electronics
- Laboratories
- General Hydraulic Applications

Physical Characteristics

Body Size (in)	Nominal Flow Diameter (mm)	Max. Operating Pressure* Non hazardous liquids & gases in Group 2		Hazardous liquids & gases in Group 1		Rated Flow**		Fluid Loss ml-cc.
		(bar)	(psi)	(bar)	(psi)	(lpm)	(gpm)	
1/8	3.8	1,000	14,500	1,000	14,500	6.1	1.61	0.4
1/4	5.7	700	10,150	700	10,150	11.6	3.06	1
3/8	7.6	600	8,700	600	8,700	16.7	4.41	2
1/2	10.3	500	7,250	500	7,250	25.5	6.74	2.5
3/4	14.2	400	5,800	400	5,800	55	14.53	5.5
1	16.5	300	4,350	300	4,350	87	22.98	9
1 1/4	20.5	200	2,900	200	2,900	140	36.98	23
1 1/2	25.8	150	2,175	38	550	208	54.95	36
2	34.7	100	1,450	28	405	357	94.3	70

* For pulsating pressures when disconnected apply a multiplier of 0.5

** Indicated values refer to a 1 bar/14.5 psi pressure drop.

Flow Data

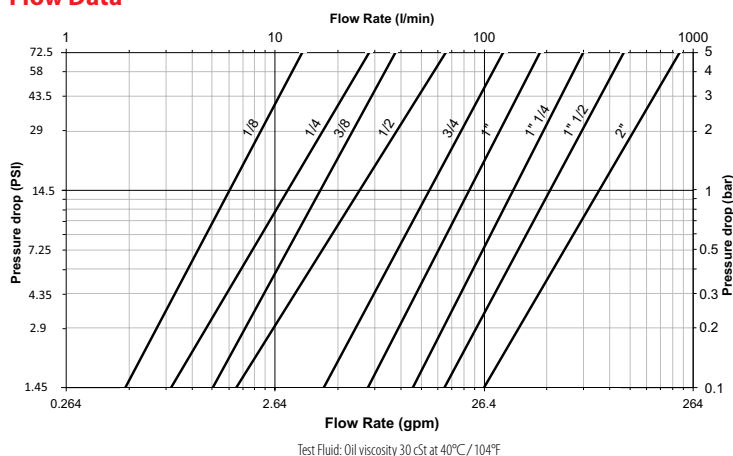

Seal Elastomer Data*

Seal Elastomer	Max. Operation Temperature Range
NBR (Nitrile)	-20°C +100°C / -4°F +212°F
FKM	-20°C +200°C / -4°F +392°F
EPDM (Ethylene-Propylene)**	-40°C +150°C / -40°F +302°F

* For reference only, based on Danfoss recommended temperatures.

** In accordance with NF L 17-241 or NAS 1613 rev. 5

Contact Danfoss technical support for further information on fluid compatibility.

H5000 Series (Steel)

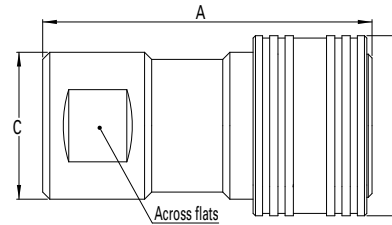

Figure 1

Sockets (Female)

Part Number			Body Size	Nominal Flow Diameter	Thread Size** (Female)			Dimensions								Weight		
NBR*	FKM	EPDM	(in)	(mm)	NPT	BSPB	Metric	Fig.	A (in)	B (in)	C (in)	Across flats (in)	A (mm)	B (mm)	C (mm)	Across flats (mm)	lbs	grams
HA0500100	HA05001V0	HA05001E0	1/8	3.8	-	1/8-28	-	1	1.65	0.94	0.83	0.63	42	24	21	16	0.19	88
HA0520100	HA05201V0	HA05201E0	1/8	3.8	1/8-27	-	-	1	1.65	0.94	0.83	0.63	42	24	21	16	0.19	88
HA0530100	HA05301V0	HA05301E0	1/8	3.8	-	-	M10x100	1	1.65	0.94	0.83	0.63	42	24	21	16	0.19	88
HA0501100	HA05011V0	HA05011E0	1/4	5.7	-	1/4-19	-	1	1.97	1.10	0.94	0.75	50	28	24	19	0.27	122
HA0521100	HA05211V0	HA05211E0	1/4	5.7	1/4-18	-	-	1	1.97	1.10	0.94	0.75	50	28	24	19	0.27	122
HA0531100	HA05311V0	HA05311E0	1/4	5.7	-	-	M14x150	1	1.97	1.10	0.94	0.75	50	28	24	19	0.27	122
HA0502100	HA05021V0	HA05021E0	3/8	7.6	-	3/8-19	-	1	2.32	1.34	1.10	0.90	59	34	28	23	0.43	197
HA0522100	HA05221V0	HA05221E0	3/8	7.6	3/8-18	-	-	1	2.32	1.34	1.10	0.90	59	34	28	23	0.43	197
HA0532100	HA05321V0	HA05321E0	3/8	7.6	-	-	M18x150	1	2.32	1.34	1.10	0.90	59	34	28	23	0.43	197
HA0503100	HA05031V0	HA05031E0	1/2	10.3	-	1/2-14	-	1	2.71	1.50	1.22	1.06	69	38	31	27	0.50	226
HA0523100	HA05231V0	HA05231E0	1/2	10.3	1/2-14	-	-	1	2.71	1.50	1.22	1.06	69	38	31	27	0.50	226
HA0533100	HA05331V0	HA05331E0	1/2	10.3	-	-	M22x150	1	2.71	1.50	1.22	1.06	69	38	31	27	0.50	226
HA0504100	HA05041V0	HA05041E0	3/4	14.2	-	3/4-14	-	1	3.50	1.89	1.57	1.38	89	48	40	35	1.27	577
HA0524100	HA05241V0	HA05241E0	3/4	14.2	3/4-14	-	-	1	3.50	1.89	1.57	1.38	89	48	40	35	1.27	577
HA0534100	HA05341V0	HA05341E0	3/4	14.2	-	-	M27x150	1	3.50	1.89	1.57	1.38	89	48	40	35	1.27	577
HA0505100	HA05051V0	HA05051E0	1	16.5	-	1-11	-	1	3.89	2.05	1.77	1.61	99	52	45	41	1.59	720
HA0525100	HA05251V0	HA05251E0	1	16.5	1-11 1/2	-	-	1	3.89	2.05	1.77	1.61	99	52	45	41	1.59	720
-	HA05061V0	HA05061E0	1 1/4	20.5	-	1 1/4-11	-	1	5.20	2.95	2.44	2.16	132	75	62	55	4.77	2,165
-	HA05071V0	HA05071E0	1 1/2	25.8	-	1 1/2-11	-	1	5.90	3.35	2.95	2.56	150	85	75	65	7.72	3,500
-	HA05091V0	HA05091E0	2	34.7	-	2-11	-	1	6.69	3.82	3.35	2.95	170	97	85	75	10.67	4,840

* Body sizes 1 1/4, 1 1/2 and 2 are supplied with FKM seals as a standard.

** Alternative end connections available upon request.

To obtain connected length of coupling add dimensions A (Fig. 1) and J (Fig. 3) together.

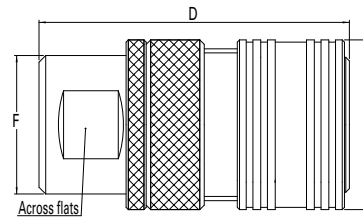

Figure 2

Sockets with Sleeve Lock (Female)

Part Number			Body Size	Nominal Flow Diameter	Thread Size** (Female)			Dimensions								Weight		
NBR*	FKM	EPDM	(in)	(mm)	NPT	BSPB	Metric	Fig.	D (in)	E (in)	F (in)	Across flats (in)	D (mm)	E (mm)	F (mm)	Across flats (mm)	lbs	grams
HA0500300	HA05003V0	HA05003E0	1/8	3.8	-	1/8-28	-	2	1.65	0.94	0.83	0.63	42	24	21	16	0.19	91
HA0520300	HA05203V0	HA05203E0	1/8	3.8	1/8-27	-	-	2	1.65	0.94	0.83	0.63	42	24	21	16	0.19	91
HA0530300	HA05303V0	HA05303E0	1/8	3.8	-	-	M10x100	2	1.65	0.94	0.83	0.63	42	24	21	16	0.19	91
HA0501300	HA05013V0	HA05013E0	1/4	5.7	-	1/4-19	-	2	1.97	1.10	0.94	0.75	50	28	24	19	0.27	134
HA0521300	HA05213V0	HA05213E0	1/4	5.7	1/4-18	-	-	2	1.97	1.10	0.94	0.75	50	28	24	19	0.27	134
HA0531300	HA05313V0	HA05313E0	1/4	5.7	-	-	M14x150	2	1.97	1.10	0.94	0.75	50	28	24	19	0.27	134
HA0502300	HA05023V0	HA05023E0	3/8	7.6	-	3/8-19	-	2	2.32	1.34	1.10	0.90	59	34	28	23	0.43	225
HA0522300	HA05223V0	HA05223E0	3/8	7.6	3/8-18	-	-	2	2.32	1.34	1.10	0.90	59	34	28	23	0.43	225
HA0532300	HA05323V0	HA05323E0	3/8	7.6	-	-	M18x150	2	2.32	1.34	1.10	0.90	59	34	28	23	0.43	225
HA0503300	HA05033V0	HA05033E0	1/2	10.3	-	1/2-14	-	2	2.71	1.50	1.22	1.06	69	38	31	27	0.50	310
HA0523300	HA05233V0	HA05233E0	1/2	10.3	1/2-14	-	-	2	2.71	1.50	1.22	1.06	69	38	31	27	0.50	310
HA0533300	HA05333V0	HA05333E0	1/2	10.3	-	-	M22x150	2	2.71	1.50	1.22	1.06	69	38	31	27	0.50	310
HA0504300	HA05043V0	HA05043E0	3/4	14.2	-	3/4-14	-	2	3.50	1.89	1.57	1.38	89	48	40	35	1.27	665
HA0524300	HA05243V0	HA05243E0	3/4	14.2	3/4-14	-	-	2	3.50	1.89	1.57	1.38	89	48	40	35	1.27	665
HA0534300	HA05343V0	HA05343E0	3/4	14.2	-	-	M27x150	2	3.50	1.89	1.57	1.38	89	48	40	35	1.27	665
HA0505300	HA05053V0	HA05053E0	1	16.5	-	1-11	-	2	3.89	2.05	1.77	1.61	99	52	45	41	1.59	813
HA0525300	HA05253V0	HA05253E0	1	16.5	1-11 1/2	-	-	2	3.89	2.05	1.77	1.61	99	52	45	41	1.59	813
-	HA05063V0	HA05063E0	1 1/4	20.5	-	1 1/4-11	-	2	5.20	2.95	2.44	2.16	132	75	62	55	4.77	2,230
-	HA05073V0	HA05073E0	1 1/2	25.8	-	1 1/2-11	-	2	5.90	3.35	2.95	2.56	150	85	75	65	7.72	3,585
-	HA05093V0	HA05093E0	2	34.7	-	2-11	-	2	6.69	3.82	3.35	2.95	170	97	85	75	10.67	5,658

* Body sizes 1 1/4, 1 1/2 and 2 are supplied with FKM seals as a standard.

** Alternative end connections available upon request.

To obtain connected length of coupling add dimensions D (Fig. 2) and J (Fig. 3) together.

H5000 Series (Steel)

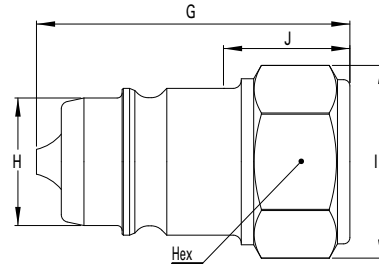

Figure 3

Plugs (Male)

Part Number			Body Size	Nominal Flow Diameter	Thread Size** (Female)			Dimensions										Weight		
NBR*	FKM	EPDM	(in)	(mm)	NPT	BSPP	Metric	Fig.	G (in)	H (in)	I (in)	J (in)	Hex (in)	G (mm)	H (mm)	I (mm)	J (mm)	Hex (mm)	lbs	grams
HA0500200	HA05002V0	HA05002E0	1/8	3.8	-	1/8-28	-	3	1.10	0.43	0.72	0.39	0.63	28	11	18.4	10	16	0.05	23
HA0520200	HA05202V0	HA05202E0	1/8	3.8	1/8-27	-	-	3	1.10	0.43	0.72	0.39	0.63	28	11	18.4	10	16	0.05	23
HA0530200	HA05302V0	HA05302E0	1/8	3.8	-	-	M10x100	3	1.10	0.43	0.72	0.39	0.63	28	11	18.4	10	16	0.05	23
HA0501200	HA05012V0	HA05012E0	1/4	5.7	-	1/4-19	-	3	1.38	0.56	0.86	0.55	0.75	35	14.2	21.8	14	19	0.08	37
HA0521200	HA05212V0	HA05212E0	1/4	5.7	1/4-18	-	-	3	1.38	0.56	0.86	0.55	0.75	35	14.2	21.8	14	19	0.08	37
HA0531200	HA05312V0	HA05312E0	1/4	5.7	-	-	M14x150	3	1.38	0.56	0.86	0.55	0.75	35	14.2	21.8	14	19	0.08	37
HA0502200	HA05022V0	HA05022E0	3/8	7.6	-	3/8-19	-	3	1.65	0.75	1.04	0.7	0.90	42	19	26.4	18	23	0.15	70
HA0522200	HA05222V0	HA05222E0	3/8	7.6	3/8-18	-	-	3	1.65	0.75	1.04	0.7	0.90	42	19	26.4	18	23	0.15	70
HA0532200	HA05322V0	HA05322E0	3/8	7.6	-	-	M18x150	3	1.65	0.75	1.04	0.7	0.90	42	19	26.4	18	23	0.15	70
HA0503200	HA05032V0	HA05032E0	1/2	10.3	-	1/2-14	-	3	1.97	0.81	1.22	0.94	1.06	50	20.6	31	24	27	0.20	92
HA0523200	HA05232V0	HA05232E0	1/2	10.3	1/2-14	-	-	3	1.97	0.81	1.22	0.94	1.06	50	20.6	31	24	27	0.20	92
HA0533200	HA05332V0	HA05332E0	1/2	10.3	-	-	M22x150	3	1.97	0.81	1.22	0.94	1.06	50	20.6	31	24	27	0.20	92
HA0504200	HA05042V0	HA05042E0	3/4	14.2	-	3/4-14	-	3	2.48	1.10	1.58	1.10	1.38	63	27.9	40.2	28	35	0.48	217
HA0524200	HA05242V0	HA05242E0	3/4	14.2	3/4-14	-	-	3	2.48	1.10	1.58	1.10	1.38	63	27.9	40.2	28	35	0.48	217
HA0534200	HA05342V0	HA05342E0	3/4	14.2	-	-	M27x150	3	2.48	1.10	1.58	1.10	1.38	63	27.9	40.2	28	35	0.48	217
HA0505200	HA05052V0	HA05052E0	1	16.5	-	1-11	-	3	2.79	1.27	1.87	1.22	1.61	71	32.4	47.5	31	41	0.63	287
HA0525200	HA05252V0	HA05252E0	1	16.5	1-11 1/2	-	-	3	2.79	1.27	1.87	1.22	1.61	71	32.4	47.5	31	41	0.63	287
-	HA05062V0	HA05062E0	1 1/4	20.5	-	1 1/4-11	-	3	3.82	1.85	2.49	1.89	2.16	97	46.9	63.2	48	55	1.98	900
-	HA05072V0	HA05072E0	1 1/2	25.8	-	1 1/2-11	-	3	4.29	2.20	2.94	2.04	2.56	109	56	74.7	52	65	3.30	1500
-	HA05092V0	HA05092E0	2	34.7	-	2-11	-	3	4.76	2.56	3.30	1.97	2.95	121	65	84	50	75	4.06	1840

* Body sizes 1 1/4, 1 1/2 and 2 are supplied with FKM seals as a standard.

** Alternative end connections available upon request.

To obtain connected length of coupling add dimensions A (Fig. 1) and J (Fig. 3) together for standard version ; add dimensions D (Fig. 2) and J (Fig. 3) together for sleeve lock version.

Dust Plugs and Dust Caps

Body Size	Socket Dust Plug Part Number	Plug Dust Cap Part Number
(in)	Anodized Aluminum	Anodized Aluminum
1/8	HD0510100	HD0510200
1/4	HD0511100	HD0511200
3/8	HD0512100	HD0512200
1/2	HD0513100	HD0513200
3/4	HD0514100	HD0514200
1	HD0515100	HD0515200
1 1/4	HD0516100	HD0516200
1 1/2	HD0517100	HD0517200
2	HD0519100	HD0519200



Seal Kit for Servicing Sockets (Female)

Body Size	Seal & Back-up Ring Kit*					
(in)	NBR seals & PTFE back-up rings	Qty	FKM seals & PTFE back-up rings	Qty	EPDM seals & PTFE back-up rings	Qty
1/8	HG 05001 00	50 O-rings + 50 Backup rings	HG 05001 V0	15 O-rings + 15 Backup rings	HG 05001 E0	15 O-rings + 15 Backup rings
1/4	HG 05011 00	50 O-rings + 50 Backup rings	HG 05011 V0	15 O-rings + 15 Backup rings	HG 05011 E0	15 O-rings + 15 Backup rings
3/8	HG 05021 00	50 O-rings + 50 Backup rings	HG 05021 V0	15 O-rings + 15 Backup rings	HG 05021 E0	15 O-rings + 15 Backup rings
1/2	HG 05031 00	50 O-rings + 50 Backup rings	HG 05031 V0	15 O-rings + 15 Backup rings	HG 05031 E0	15 O-rings + 15 Backup rings
3/4	HG 05041 00	50 O-rings + 50 Backup rings	HG 05041 V0	15 O-rings + 15 Backup rings	HG 05041 E0	15 O-rings + 15 Backup rings
1	HG 05051 00	50 O-rings + 50 Backup rings	HG 05051 V0	10 O-rings + 10 Backup rings	HG 05051 E0	10 O-rings + 10 Backup rings
1 1/4	HG 05061 00	15 O-rings + 15 Backup rings	HG 05061 V0	5 O-rings + 5 Backup rings	-	-
1 1/2	HG 05071 00	15 O-rings + 15 Backup rings	-	-	-	-
2	HG 05091 00	15 O-rings + 15 Backup rings	-	-	-	-

*The valve seal is not included in our repair kits

H5000 Series (Brass)

Fluid transfer & Hydraulic application



Product Features

- Proprietary profile
- Pull-to-connect with double shut-off valving
- Ball-locking
- Pressure performance
- Optional safety sleeve lock prevents accidental disconnections
- Optional dust caps and plugs (made of anodized aluminum)
- Standard body material: Nickel-plated brass
- Standard seal material: NBR, FKM, EPDM

European Pressure Equipment Directive

All couplings are designed and manufactured under Article 4.3 of the European Pressure Equipment Directive PED 2014/68/EU. Couplings with nominal diameters greater than 25 mm should not be used to convey gases in Group 1 (hazardous).

Group 1 = Hazardous media / Group 2 = Other media

Applications & Markets

- Automobile
- Agriculture
- Construction
- Oil and Gas
- Railway
- Aeronautics
- Food Processing
- Iron and Steel Industry
- Electronics
- Laboratories
- General Hydraulic Applications

Danfoss' H5000 Series brass quick disconnect coupling is a pull to connect double shut-off coupling. It is a general purpose industrial quick disconnect coupling with the original profile. Mainly used in fluid transfer applications where stainless steel is not a requirement, it offers a good alternative for corrosion resistance.

Physical Characteristics

Body Size	Nominal Flow Diameter*	Max. Operating Pressure**				Rated Flow***		Fluid Loss
		Hazardous liquids in Group 1&2	Non hazardous Gases in Group 2	Rated Flow***	Fluid Loss			
(in)	(mm)	(bar)	(psi)	(bar)	(psi)	(lpm)	(gpm)	ml-cc.
1/8	3.8	300	4,350	300	4,350	6.1	1.61	0.4
1/4	5.7	230	3,335	230	3,335	11.6	3.06	1
3/8	7.6	175	2,535	175	2,535	16.7	4.41	2
1/2	10.3	150	2,175	150	2,175	25.5	6.74	2.5
3/4	14.2	125	1,810	125	1,810	55	14.53	5.5
1	16.5	100	1,450	100	1,450	87	22.98	9
1 1/4	20.5	70	1,015	70	1,015	140	36.98	23
1 1/2	25.8	50	725	50	725	208	54.95	36
2	34.7	40	290	28	406	357	94.3	70

* Nominal diameters over 25 mm should not be used to convey gases in Group 1 (PED 2014/68/EU)

** For pulsating pressures when disconnected apply a multiplier of 0.5

*** Indicated values refer to a 1 bar/14.5 psi pressure drop.

Flow Data

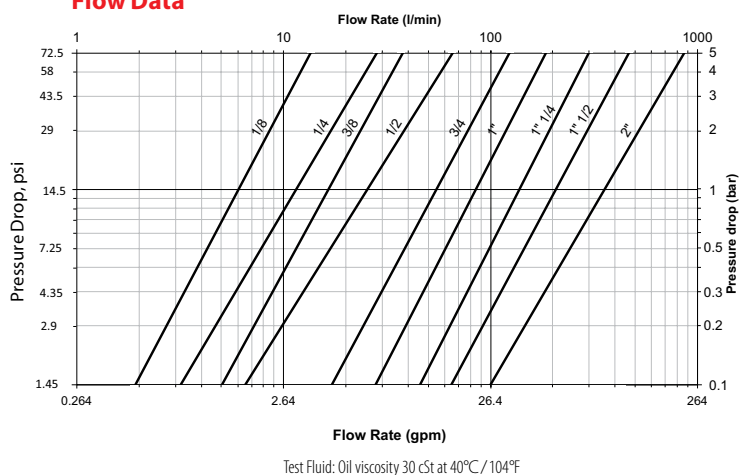

Seal Elastomer Data*	
Seal Elastomer	Max. Operation Temperature Range
NBR (Nitrile)	-20°C +100°C/-4°F +212°F
FKM (Fluorocarbon)	-20°C +200°C/-4°F +392°F
EPDM (Ethylene-Propylene)**	-40°C +150°C/-40°F +302°F

* For reference only, based on Danfoss recommended temperatures.

** In accordance with NF L 17-241 or NAS 1613 rev. 5

Contact Danfoss technical support for further information on fluid compatibility.

H5000 Series (Brass)

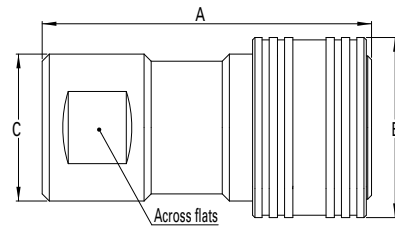

Figure 1

Sockets (Female)

Part Number			Body Size (in)	Nominal Flow Diameter (mm)	Thread Size* (Female) BSPP	Fig.	Dimensions							Weight		
NBR	FKM	EPDM					A (in)	B (in)	C (in)	Across flats (in)	A (mm)	B (mm)	C (mm)	Across flats (mm)	lbs	grams
HL0500100	HL05001V0	HL05001E0	1/8	3.8	1/8-28	1	1.65	0.94	0.83	0.63	42	24	21	16	0.21	97
HL0501100	HL05011V0	HL05011E0	1/4	5.7	1/4-19	1	1.97	1.10	0.94	0.75	50	28	24	19	0.30	134
HL0502100	HL05021V0	HL05021E0	3/8	7.6	3/8-19	1	2.32	1.34	1.10	0.90	59	34	28	23	0.48	217
HL0503100	HL05031V0	HL05031E0	1/2	10.3	1/2-14	1	2.71	1.50	1.22	1.06	69	38	31	27	0.55	249
HL0504100	HL05041V0	HL05041E0	3/4	14.2	3/4-14	1	3.50	1.89	1.57	1.38	89	48	40	35	1.40	635
HL0505100	HL05051V0	HL05051E0	1	16.5	1-11	1	3.89	2.05	1.77	1.61	99	52	45	41	1.75	792
HL0506100	HL05061V0	HL05061E0	1 1/4	20.5	1 1/4-11	1	5.20	2.95	2.44	2.16	132	75	62	55	5.25	2,382
HL0507100	HL05071V0	HL05071E0	1 1/2	25.8	1 1/2-11	1	5.90	3.35	2.95	2.56	150	85	75	65	8.49	3,850
HL0509100	HL05091V0	HL05091E0	2	34.7	2-11	1	6.69	3.82	3.35	2.95	170	97	85	75	11.74	5,324

* Alternative end connections available upon request.

To obtain connected length of coupling add dimensions A (Fig. 1) and J (Fig. 3) together.

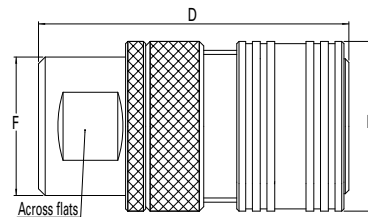

Figure 2

Sockets with Sleeve Lock (Female)

Part Number			Body Size (in)	Nominal Flow Diameter (mm)	Thread Size* (Female) BSPP	Fig.	Dimensions							Weight		
NBR	FKM	EPDM					D (in)	E (in)	F (in)	Across flats (in)	D (mm)	E (mm)	F (mm)	Across flats (mm)	lbs	grams
HL0500300	HL05003V0	HL05003E0	1/8	3.8	1/8-28	2	1.65	0.94	0.83	0.63	42	24	21	16	0.22	100
HL0501300	HL05013V0	HL05013E0	1/4	5.7	1/4-19	2	1.97	1.10	0.94	0.75	50	28	24	19	0.33	148
HL0502300	HL05023V0	HL05023E0	3/8	7.6	3/8-19	2	2.32	1.34	1.10	0.90	59	34	28	23	0.55	248
HL0503300	HL05033V0	HL05033E0	1/2	10.3	1/2-14	2	2.71	1.50	1.22	1.06	69	38	31	27	0.75	341
HL0504300	HL05043V0	HL05043E0	3/4	14.2	3/4-14	2	3.50	1.89	1.57	1.38	89	48	40	35	1.61	732
HL0505300	HL05053V0	HL05053E0	1	16.5	1-11	2	3.89	2.05	1.77	1.61	99	52	45	41	1.97	894
HL0506300	HL05063V0	HL05063E0	1 1/4	20.5	1 1/4-11	2	5.20	2.95	2.44	2.16	132	75	62	55	5.41	2,453
HL0507300	HL05073V0	HL05073E0	1 1/2	25.8	1 1/2-11	2	5.90	3.35	2.95	2.56	150	85	75	65	8.69	3,944
HL0509300	HL05093V0	HL05093E0	2	34.7	2-11	2	6.69	3.82	3.35	2.95	170	97	85	75	13.72	6,224

* Alternative end connections available upon request.

To obtain connected length of coupling add dimensions D (Fig. 2) and J (Fig. 3) together.

H5000 Series (Brass)

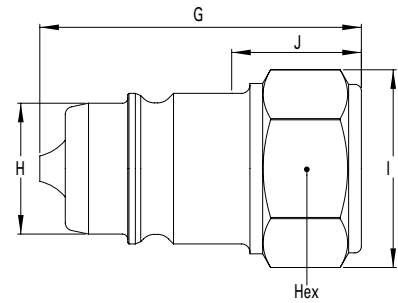

Figure 3

Plugs (Male)

Part Number			Body Size	Nominal Flow Diameter	Thread Size** (Female)	Dimensions											Weight	
NBR*	FKM	EPDM	(in)	(mm)	BSPP	Fig.	G (in)	H (in)	I (in)	J (in)	Hex (in)	G (mm)	H (mm)	I (mm)	J (mm)	Hex (mm)	lbs	grams
HL0500200	HL05002V0	HL05002E0	1/8	3.8	1/8-28	3	1.1	0.43	0.72	0.39	0.63	28	11	18.4	10	16	0.06	26
HL0501200	HL05012V0	HL05012E0	1/4	5.7	1/4-19	3	1.38	0.56	0.86	0.55	0.75	35	14.2	21.8	14	19	0.09	41
HL0502200	HL05022V0	HL05022E0	3/8	7.6	3/8-19	3	1.65	0.75	1.04	0.70	0.90	42	19	26.4	18	23	0.17	77
HL0503200	HL05032V0	HL05032E0	1/2	10.3	1/2-14	3	1.97	0.81	1.22	0.94	1.06	50	20.6	31	24	27	0.22	101
HL0504200	HL05042V0	HL05042E0	3/4	14.2	3/4-14	3	2.48	1.10	1.58	1.10	1.38	63	27.9	40.2	28	35	0.53	239
HL0505200	HL05052V0	HL05052E0	1	16.5	1-11	3	2.79	1.27	1.87	1.22	1.61	71	32.4	47.5	31	41	0.70	316
-	HL05062V0	HL05062E0	1 1/4	20.5	1 1/4-11	3	3.82	1.85	2.49	1.89	2.16	97	46.9	63.2	48	55	2.18	990
-	HL05072V0	HL05072E0	1 1/2	25.8	1 1/2-11	3	4.29	2.20	2.94	2.04	2.56	109	56	74.7	52	65	3.64	1650
-	HL05092V0	HL05092E0	2	34.7	2-11	3	4.76	2.56	3.30	1.97	2.95	121	65	84	50	75	4.46	2024

* Body sizes 1 1/4, 1 1/2 and 2 are supplied with FKM seals as a standard.

** Alternative end connections available upon request.

To obtain connected length of coupling add dimensions A (Fig. 1) and J (Fig. 3) together for standard version; add dimensions D (Fig. 2) and J (Fig. 3) together for sleeve lock version

Dust Plugs and Dust Caps

Body Size (in)	Socket Dust Plug Part Number Anodized Aluminum	Plug Dust Cap Part Number Anodized Aluminum
1/8	HD0510100	HD0510200
1/4	HD0511100	HD0511200
3/8	HD0512100	HD0512200
1/2	HD0513100	HD0513200
3/4	HD0514100	HD0514200
1	HD0515100	HD0515200
1 1/4	HD0516100	HD0516200
1 1/2	HD0517100	HD0517200
2	HD0519100	HD0519200



Seal Kit for Servicing Sockets (Female)

Body Size (in)	Seal & Back-up Ring Kit*					
	NBR seals & PTFE back-up rings	Qty	FKM seals & PTFE back-up rings	Qty	EPDM seals & PTFE back-up rings	Qty
1/8	HG 05001 00	50 O-rings + 50 Backup rings	HG 05001 V0	15 O-rings + 15 Backup rings	HG 05001 E0	15 O-rings + 15 Backup rings
1/4	HG 05011 00	50 O-rings + 50 Backup rings	HG 05011 V0	15 O-rings + 15 Backup rings	HG 05011 E0	15 O-rings + 15 Backup rings
3/8	HG 05021 00	50 O-rings + 50 Backup rings	HG 05021 V0	15 O-rings + 15 Backup rings	HG 05021 E0	15 O-rings + 15 Backup rings
1/2	HG 05031 00	50 O-rings + 50 Backup rings	HG 05031 V0	15 O-rings + 15 Backup rings	HG 05031 E0	15 O-rings + 15 Backup rings
3/4	HG 05041 00	50 O-rings + 50 Backup rings	HG 05041 V0	15 O-rings + 15 Backup rings	HG 05041 E0	15 O-rings + 15 Backup rings
1	HG 05051 00	50 O-rings + 50 Backup rings	HG 05051 V0	10 O-rings + 10 Backup rings	HG 05051 E0	10 O-rings + 10 Backup rings
1 1/4	HG 05061 00	15 O-rings + 15 Backup rings	HG 05061 V0	5 O-rings + 5 Backup rings	-	-
1 1/2	HG 05071 00	15 O-rings + 15 Backup rings	-	-	-	-
2	HG 05091 00	15 O-rings + 15 Backup rings	-	-	-	-

*The valve seal is not included in our repair kits

H5000 Series (Stainless Steel)

Fluid transfer & Hydraulic application



Danfoss' H5000 Series stainless steel quick disconnect coupling is a pull to connect double shut-off coupling. It is a general purpose industrial coupling with the original profile. It is mainly used in fluid transfer applications and provides excellent corrosion resistance.

Product Features

- Proprietary profile
- Pull-to-connect with double shut-off valving
- Ball-locking
- Optional safety sleeve lock prevents accidental disconnections
- Optional dust caps and plugs (made of anodized aluminum)
- Pressure performance
- Standard body material: AISI 316L Stainless steel
- Standard seal material: FKM, EPDM

European Pressure Equipment Directive

Couplings with nominal diameters up to and including 25 mm are designed and manufactured under Article 4.3 of the European Pressure Equipment Directive PED 2014/68/EU. Couplings with nominal diameters greater than 25 mm are designed and manufactured in accordance with the stipulations of Module A of the European Pressure Equipment Directive PED 2014/68/EU. They should not be used to convey unstable gases.

Group 1 = Hazardous media / Group 2 = Other media

Physical Characteristics

Body Size (in)	Nominal Flow Diameter (mm)	Max. Operating Pressure*				Rated Flow**		Fluid Loss ml-cc.
		Non hazardous liquids & gases Group 2		Hazardous liquids & gases Group 1		(lpm)	(gpm)	
1/8	3.8	300	4,350	300	4,350	6.1	1.61	0.4
1/4	5.7	230	3,335	230	3,335	11.6	3.06	1
3/8	7.6	175	2,535	175	2,535	16.7	4.41	2
1/2	10.3	150	2,175	150	2,175	25.5	6.74	2.5
3/4	14.2	125	1,810	125	1,810	55	14.53	5.5
1	16.5	100	1,450	100	1,450	87	22.98	9
1 1/4	20.5	100	1,450	100	1,450	140	36.98	23
1 1/2	25.8	75	1,085	28	550	208	54.95	36
2	34.7	40	580	38	405	357	94.30	70

* For pulsating pressures when disconnected apply a multiplier of 0.5

** Indicated values refer to a 1 bar/14.5 psi pressure drop.

Applications & Markets

- Automobile
- Agriculture
- Construction
- Oil and Gas
- Railway
- Aeronautics
- Food Processing
- Iron and Steel Industry
- Electronics
- Laboratories
- General Hydraulic Applications

Flow Data

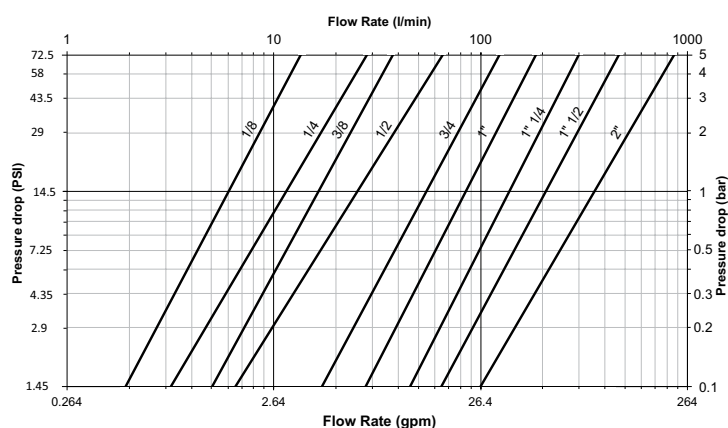

Test Fluid: Oil viscosity 30 cSt at 40°C/ 104°F

Seal Elastomer Data*	
Seal Elastomer	Max. Operation Temperature Range
FKM	-20°C +200°C/-4°F +392°F
EPDM (Ethylene-Propylene)**	-40°C +150°C/-40°F +302°F

* For reference only, based on Danfoss recommended temperatures.

** In accordance with NF L 17-241 or NAS 1613 rev. 5

Contact Danfoss technical support for further information on fluid compatibility.

H5000 Series (Stainless Steel)

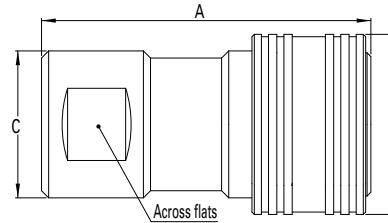

Figure 1

Sockets (Female)

Part Number		Body Size	Nominal Flow Diameter	Thread Size* (Female)		Dimensions								Weight		
FKM	EPDM	(in)	(mm)	NPT	BSPP	Fig.	A (in)	B (in)	C (in)	Across flats (in)	A (mm)	B (mm)	C (mm)	Across flats (mm)	lbs	grams
HZ05001V0	HZ05001E0	1/8	3.8	-	1/8-28	1	1.65	0.94	0.83	0.63	42	24	21	16	0.19	88
HZ05201V0	HZ05201E0	1/8	3.8	1/8-27	-	1	1.65	0.94	0.83	0.63	42	24	21	16	0.19	88
HZ05011V0	HZ05011E0	1/4	5.7	-	1/4-19	1	1.97	1.10	0.94	0.75	50	28	24	19	0.27	122
HZ05211V0	HZ05211E0	1/4	5.7	1/4-18	-	1	1.97	1.10	0.94	0.75	50	28	24	19	0.27	122
HZ05021V0	HZ05021E0	3/8	7.6	-	3/8-19	1	2.32	1.34	1.10	0.90	59	34	28	23	0.43	197
HZ05221V0	HZ05221E0	3/8	7.6	3/8-18	-	1	2.32	1.34	1.10	0.90	59	34	28	23	0.43	197
HZ05031V0	HZ05031E0	1/2	10.3	-	1/2-14	1	2.71	1.50	1.22	1.06	69	38	31	27	0.50	226
HZ05231V0	HZ05231E0	1/2	10.3	1/2-14	-	1	2.71	1.50	1.22	1.06	69	38	31	27	0.50	226
HZ05041V0	HZ05041E0	3/4	14.2	-	3/4-14	1	3.50	1.89	1.57	1.38	89	48	40	35	1.27	577
HZ05241V0	HZ05241E0	3/4	14.2	3/4-14	-	1	3.50	1.89	1.57	1.38	89	48	40	35	1.27	577
HZ05051V0	HZ05051E0	1	16.5	-	1-11	1	3.89	2.05	1.77	1.61	99	52	45	41	1.59	720
HZ05251V0	HZ05251E0	1	16.5	1-11 1/2	-	1	3.89	2.05	1.77	1.61	99	52	45	41	1.59	720
HZ05061V0	HZ05061E0	1 1/4	20.5	-	1 1/4-11	1	5.20	2.95	2.44	2.16	132	75	62	55	4.77	2,165
HZ05071V0	HZ05071E0	1 1/2	25.8	-	1 1/2-11	1	5.90	3.35	2.95	2.56	150	85	75	65	7.72	3,500
HZ05091V0	HZ05091E0	2	34.7	-	2-11	1	6.69	3.82	3.35	2.95	170	97	85	75	10.67	4,840

* Alternative end connections available upon request.

To obtain connected length of coupling add dimensions A (Fig. 1) and J (Fig. 3) together.

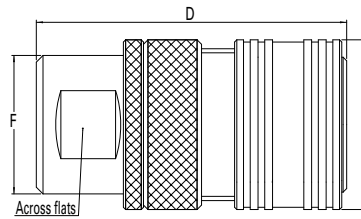

Figure 2

Sockets with Sleeve Lock (Female)

Part Number		Body Size	Nominal Flow Diameter	Thread Size* (Female)	Dimensions								Weight		
FKM	EPDM	(in)	(mm)	BSPP	Fig.	D (in)	E (in)	F (in)	Across flats (in)	D (mm)	E (mm)	F (mm)	Across flats (mm)	lbs	grams
HZ05003V0	HZ05003E0	1/8	3.8	1/8-28	2	1.65	0.94	0.83	0.63	42	24	21	16	0.19	91
HZ05013V0	HZ05013E0	1/4	5.7	1/4-19	2	1.97	1.10	0.94	0.75	50	28	24	19	0.27	134
HZ05023V0	HZ05023E0	3/8	7.6	3/8-19	2	2.32	1.34	1.10	0.90	59	34	28	23	0.43	225
HZ05033V0	HZ05033E0	1/2	10.3	1/2-14	2	2.71	1.50	1.22	1.06	69	38	31	27	0.50	310
HZ05043V0	HZ05043E0	3/4	14.2	3/4-14	2	3.50	1.89	1.57	1.38	89	48	40	35	1.27	665
HZ05053V0	HZ05053E0	1	16.5	1-11	2	3.89	2.05	1.77	1.61	99	52	45	41	1.59	813
HZ05063V0	HZ05063E0	1 1/4	20.5	1 1/4-11	2	5.20	2.95	2.44	2.16	132	75	62	55	4.77	2,230
HZ05073V0	HZ05073E0	1 1/2	25.8	1 1/2-11	2	5.90	3.35	2.95	2.56	150	85	75	65	7.72	3,585
HZ05093V0	HZ05093E0	2	34.7	2-11	2	6.69	3.82	3.35	2.95	170	97	85	75	10.67	5,658

* Alternative end connections available upon request.

To obtain connected length of coupling add dimensions D (Fig. 2) and J (Fig. 3) together.

H5000 Series (Stainless Steel)

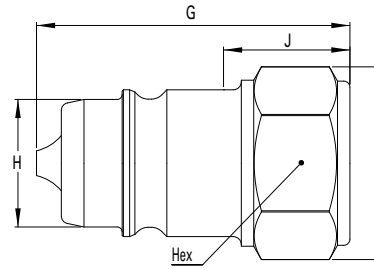

Figure 3

Plugs (Male)

Part Number		Body Size	Nominal Flow Diameter	Thread Size* (Female)		Fig.	Dimensions										Weight	
FKM	EPDM	(in)	(mm)	NPT	BSPF		G (in)	H (in)	I (in)	J (in)	Hex (in)	G (mm)	H (mm)	I (mm)	J (mm)	Hex (mm)	lbs	grams
HZ05002V0	HZ05002E0	1/8	3.8	-	1/8-28	3	1.10	0.43	0.72	0.39	0.63	28	11	18.4	10	16	0.05	23
HZ05202V0	HZ05202E0	1/8	3.8	1/8-27	-	3	1.10	0.43	0.72	0.39	0.63	28	11	18.4	10	16	0.05	23
HZ05012V0	HZ05012E0	1/4	5.7	-	1/4-19	3	1.38	0.56	0.86	0.55	0.75	35	14.2	21.8	14	19	0.08	37
HZ05212V0	HZ05212E0	1/4	5.7	1/4-18	-	3	1.38	0.56	0.86	0.55	0.75	35	14.2	21.8	14	19	0.08	37
HZ05022V0	HZ05022E0	3/8	7.6	-	3/8-19	3	1.65	0.75	1.04	0.70	0.90	42	19	26.4	18	23	0.15	70
HZ05222V0	HZ05222E0	3/8	7.6	3/8-18	-	3	1.65	0.75	1.04	0.70	0.90	42	19	26.4	18	23	0.15	70
HZ05032V0	HZ05032E0	1/2	10.3	-	1/2-14	3	1.97	0.81	1.22	0.94	1.06	50	20.6	31	24	27	0.20	92
HZ05232V0	HZ05232E0	1/2	10.3	1/2-14	-	3	1.97	0.81	1.22	0.94	1.06	50	20.6	31	24	27	0.20	92
HZ05042V0	HZ05042E0	3/4	14.2	-	3/4-14	3	2.48	1.10	1.58	1.10	1.38	63	27.9	40.2	28	35	0.48	217
HZ05242V0	HZ05242E0	3/4	14.2	3/4-14	-	3	2.48	1.10	1.58	1.10	1.38	63	27.9	40.2	28	35	0.48	217
HZ05052V0	HZ05052E0	1	16.5	-	1-11	3	2.79	1.27	1.87	1.22	1.61	71	32.4	47.5	31	41	0.63	287
HZ05252V0	HZ05252E0	1	16.5	1-11 1/2	-	3	2.79	1.27	1.87	1.22	1.61	71	32.4	47.5	31	41	0.63	287
HZ05062V0	HZ05062E0	1 1/4	20.5	-	1 1/4-11	3	3.82	1.85	2.49	1.89	2.16	97	46.9	63.2	48	55	1.98	900
HZ05072V0	HZ05072E0	1 1/2	25.8	-	1 1/2-11	3	4.29	2.20	2.94	2.04	2.56	109	56	74.7	52	65	3.30	1500
HZ05092V0	HZ05092E0	2	34.7	-	2-11	3	4.76	2.56	3.30	1.97	2.95	121	65	84	50	75	4.06	1840

* Alternative end connections available upon request.

To obtain connected length of coupling add dimensions A (Fig. 1) and J (Fig. 3) together for standard version; add Dimensions D (Fig. 2) and J (Fig. 3) together for sleeve lock version

Dust Plugs and Dust Caps

Body Size (in)	Socket Dust Plug Part Number Anodized Aluminum	Plug Dust Cap Part Number Anodized Aluminum
1/8	HD0510100	HD0510200
1/4	HD0511100	HD0511200
3/8	HD0512100	HD0512200
1/2	HD0513100	HD0513200
3/4	HD0514100	HD0514200
1	HD0515100	HD0515200
1 1/4	HD0516100	HD0516200
1 1/2	HD0517100	HD0517200
2	HD0519100	HD0519200



Seal Kit for Servicing Sockets (Female)

Body Size (in)	Seal & Back-up Ring Kit*					
	NBR seals & PTFE back-up rings	Qty	FKM seals & PTFE back-up rings	Qty	EPDM seals & PTFE back-up rings	Qty
1/8	HG 05001 00	50 O-rings + 50 Backup rings	HG 05001 V0	15 O-rings + 15 Backup rings	HG 05001 E0	15 O-rings + 15 Backup rings
1/4	HG 05011 00	50 O-rings + 50 Backup rings	HG 05011 V0	15 O-rings + 15 Backup rings	HG 05011 E0	15 O-rings + 15 Backup rings
3/8	HG 05021 00	50 O-rings + 50 Backup rings	HG 05021 V0	15 O-rings + 15 Backup rings	HG 05021 E0	15 O-rings + 15 Backup rings
1/2	HG 05031 00	50 O-rings + 50 Backup rings	HG 05031 V0	15 O-rings + 15 Backup rings	HG 05031 E0	15 O-rings + 15 Backup rings
3/4	HG 05041 00	50 O-rings + 50 Backup rings	HG 05041 V0	15 O-rings + 15 Backup rings	HG 05041 E0	15 O-rings + 15 Backup rings
1	HG 05051 00	50 O-rings + 50 Backup rings	HG 05051 V0	10 O-rings + 10 Backup rings	HG 05051 E0	10 O-rings + 10 Backup rings
1 1/4	HG 05061 00	15 O-rings + 15 Backup rings	HG 05061 V0	5 O-rings + 5 Backup rings	-	-
1 1/2	HG 05071 00	15 O-rings + 15 Backup rings	-	-	-	-
2	HG 05091 00	15 O-rings + 15 Backup rings	-	-	-	-

*The valve seal is not included in our repair kits

FD72/FD76 Series

Connect Under Pressure — Farm ISO 5675 Interchange

Fluid transfer & Hydraulic application



Danfoss Hansen FD72 Series coupling incorporates special valving allowing connection to a FD76 Series male half under pressure. The maximum operating pressure is 3,000 psi. Contains an over travel, selfsealing poppet valve construction for connecting to a pressurized male tip. Applications require that the tractor control valve be actuated to open the flow path and to equalize the pressure.

Product Features

- Push-to-connect for one-hand operation when sleeve is mounted
- Interchanges with ISO 5675 plug/male tips
- Retaining ring groove on socket/female half for bulkhead and breakaway frame mounting
- Standard seal material: Buna-N
- Standard body material: High resistance carbon steel with zinc trivalent plating

Applications & Markets

- Hydraulic fluid transfer
- Agricultural equipment

Physical Characteristics

Body Size (in)	Max. Operating Pressure		Min. Burst Pressure Connected		Vacuum Connected Only (in./Hg)	Rated Flow		Air Inclusion cc. max.	Fluid Loss cc.max.
	(bar)	(psi)	(bar)	(psi)		(lpm)	(gpm)		
5/8	207	3,000	827	12,000	28	61	16	2.8	2.8

Dimensions (Female NPT, Valved)

Part Number Buna-N	Coupling Type	Body Size	Port Size	Thread	Type	Fig.	Dimensions								
							A	B	C	D	E	Hex			
FD76-1002-08-10	Plug/Male	5/8	1/2	1/2-14	Female Pipe	1	52.1 (2.05)	—	—	—	—	—	—	—	26.9 (1.06)
FD72-1001-08-10	Socket/Female	5/8	1/2	1/2-14	Female Pipe	2	80.5 (3.17)	38.6 (1.52)	38.1 (1.50)	35.8 (1.41)	5.1 (.20)	—	—	25.4 (1.00)	
FD76-1010-08-10	Plug/Male	5/8	1/2	3/4-16	Female SAE O-Ring	3	52.1 (2.05)	—	—	—	—	—	—	27.0 (1.06)	

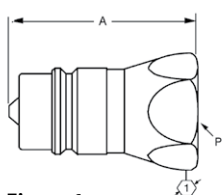

Figure 1

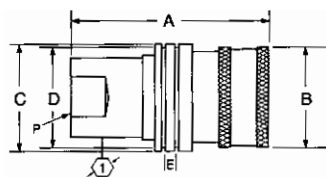

Figure 2

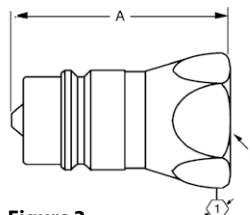

Figure 3

Dust Cap

Part Number Buna-N	Body Size
5657-10	5/8



Dust Cap

Dust Plug

Part Number Buna-N	Body Size
5659-10	5/8



Dust Plug

Break Away Frame

Part Number Buna-N	Body Size
5603	5/8



Break Away Frame

Flow Data

Pressure Drop Versus Flow Graph

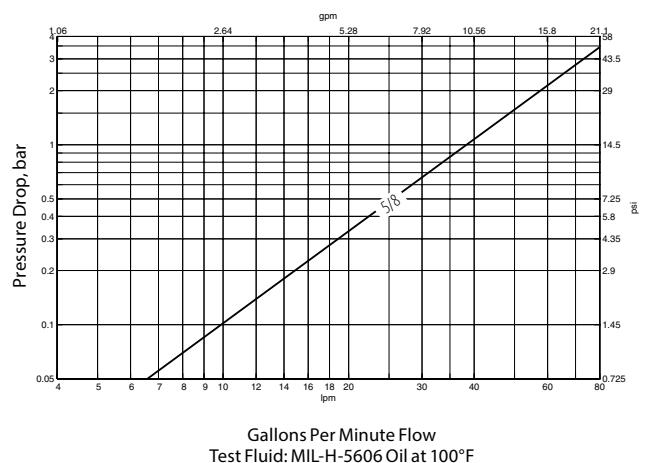

HK Series (Steel)

ISO 7241-1 B Interchange

Fluid transfer & Hydraulic application



Product Features

- Meets dimensional requirements to ISO standard 7241-1 Series B
- The coupling that sets the industry standard
- Self-sealing poppet valve design provides excellent high and low pressure sealing
- Standard seal material: Nitrile (NBR)
- Seal options available in PTFE, Neoprene, FKM, EPDM, and Kalrez®
- Standard body material: Zinc trivalent plated steel with stainless steel springs, balls and retaining rings.
- PTFE back up rings in sockets (females)

Physical Characteristics

Series	Body Size (in)	ISO Size (mm)	Nominal Flow Diameter (mm)	Max. Operating Pressure				Rated Flow*		Air Inclusion cc. max.	Fluid Loss cc. max.
				Non hazardous liquids & gases Group 2		Hazardous liquids & gases Group 1		(lpm)	(gpm)		
			(bar)	(psi)	(bar)	(psi)					
1HK	1/8	5	4.4	275	4,000	275	4,000	3	0.8	0.6	0.5
2HK	1/4	6.3	5.9	345	5,000	345	5,000	12	3	1.2	0.9
3HK	3/8	10	7.8	275	4,000	275	4,000	23	6	2.9	2.1
4HK	1/2	12.5	10	345	5,000	345	5,000	45	12	3.6	3.5
6HK	3/4	20	17	275	4,000	275	4,000	100	26	11.5	9.3
8HK	1	25	19.6	275	4,000	275	4,000	189	50	18.0	16.9
10HK	1 1/4**	—	26.7	200	2900	37	537	288	76	48.0	48.0
12HK	1 1/2	40	35.1	150	2175	29	421	375	99	91.3	91.3
20HK	2 1/2	50	46	100	1450	21	305	757	200	209.9	209.9

* For questions related to vacuum please contact Danfoss.

** No ISO Standard available for the 10HK

Applications & Markets

- Agriculture
- Hydraulic Tool
- General Industry
- Construction
- Fluid Transfer
- Transportation
- Military
- Law Enforcement/Rescue
- Chemical
- Oil and Gas
- Consumer Products
- HVAC
- Food and Beverage
- Trucks
- Aerospace
- Medical

Danfoss Hansen HK Series coupling sets the industry standard for ISO B Couplings. The HK Series features a rugged ball latch mechanism with automatic self-sealing poppet valves in a wide array of port configurations and multiple valved and non-valved configurations.

European Pressure Equipment Directive

Couplings with nominal diameters up to and including 25 mm are designed and manufactured under Article 4.3 of the European Pressure Equipment Directive 2014/68/EU. Couplings with nominal diameters greater than 25 mm are designed and manufactured in accordance with stipulations of Module A of the European Pressure Equipment Directive 2014/68/EU. They should not be used to convey unstable gases.

Group 1 = Hazardous media / Group 2 = Other media

Flow Data

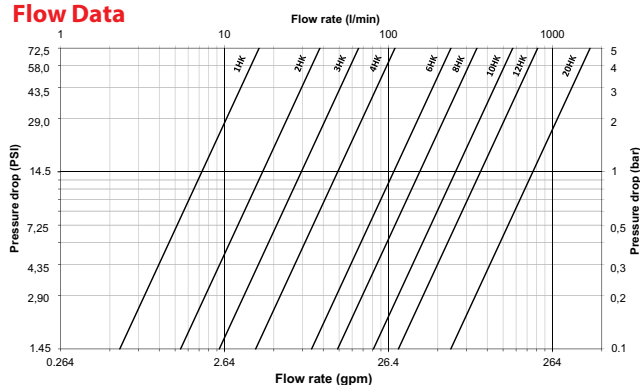

Hydraulic Oil viscosity : 30 Cst at 40°C / 104°F

Seal Elastomer Data*

Seal Elastomer**	Max. Operation Temperature Range
Nitrile (NBR)	-40°C to +121°C / 40°F to +250°F
Neoprene	-54°C to +100°C / -65°F to +212°F
EPDM	-54°C to +149°C / -65°F to +300°F
FKM	-29°C to +204°C / -15°F to +400°F

* For reference only, based on Danfoss recommended temperatures.

** For seals not listed contact Danfoss.

Contact Danfoss technical support for further information on fluid compatibility.

HK Series (Steel)

ISO 7241-1 B Interchange

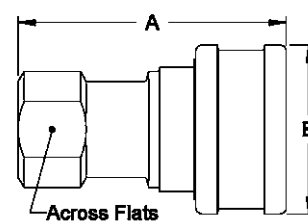

Figure 1

Sockets (Female)

Part Number HK1-8 Series	Body Size (in)	ISO Size (mm)	Thread Size (Female)			Fig.	Dimensions					
			NPTF	BSPP	SAE		A (in)	B (in)	Across Flats (in)	A (mm)	B (mm)	Across Flats (mm)
1H11	1/8	5	1/8-27	-	-	1	1.91	0.98	0.56	48.5	24.9	14.2
1H4	1/8	5	-	-	7/16-20	1	2.06	0.98	0.69	52.3	24.9	17.5
2H16	1/4	6.3	1/4-18	-	-	1	2.26	1.14	0.75	57.4	29.0	19.1
2H16BS	1/4	6.3	-	1/4-19	-	1	2.31	1.14	0.75	58.7	29.0	19.1
2H6	1/4	6.3	-	-	9/16-18	1	2.40	1.14	0.88	61.0	29.0	22.4
3H21	3/8	10	3/8-18	-	-	1	2.56	1.42	0.88	65.0	36.1	22.4
3H21BS	3/8	10	-	3/8-19	-	1	2.56	1.42	0.88	65.0	36.1	22.4
3H8	3/8	10	-	-	3/4-16	1	2.74	1.42	1.00	69.6	36.1	25.4
4HP26	1/2	12.5	1/2-14	-	-	1	2.96	1.86	1.13	75.2	47.2	28.7
4HP26BS	1/2	12.5	-	1/2-14	-	1	2.96	1.86	1.13	75.2	47.2	28.7
4HP10	1/2	12.5	-	-	7/8-14	1	3.05	1.86	1.25	77.5	47.2	31.8
6HP31	3/4	20	3/4-14	-	-	1	3.48	2.22	1.31	88.4	56.4	33.3
6HP31BS	3/4	20	-	3/4-14	-	1	3.48	2.22	1.31	88.4	56.4	33.3
6HP12	3/4	20	-	-	1 1/16-12	1	3.67	2.22	1.38	93.2	56.4	35.1
8HP36	1	25	1-11 1/2	-	-	1	4.13	2.61	1.75	104.9	66.3	44.5
8HP36BS	1	25	-	1-11	-	1	4.13	2.61	1.75	104.9	66.3	44.5
8HP16	1	25	-	-	1 1/16-12	1	4.13	2.61	1.88	104.9	66.3	47.8

A=Overall Length, B=Maximum Diameter

To obtain connected length of coupling, add dimensions A (Fig. 1) and E (Fig. 3) together.

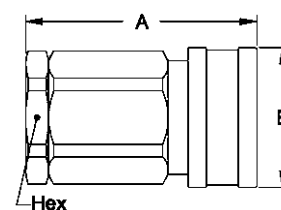

Figure 2

Sockets (Female)

Part Number HK10/12/20 Series	Body Size (in)	ISO Size (mm)	Thread Size (Female)		Fig.	Dimensions					
			NPTF	BSPP		A (in)	B (in)	Hex (in)	A (mm)	B (mm)	Hex (mm)
10H41*	1 1/4	-	1 1/4-11 1/2	-	2	4.51	2.73	2.38	114.6	69.3	60.5
10H41BS*	1 1/4	-	-	1 1/4-11	2	4.51	2.73	2.38	114.6	69.3	60.5
12H41	1 1/2	40	1 1/4-11 1/2	-	2	4.82	3.23	2.38	122.4	82.0	60.5
12H41BS	1 1/2	40	-	1 1/4-11	2	4.82	3.23	2.38	122.4	82.0	60.5
12H46	1 1/2	40	1 1/2-11 1/2	-	2	4.82	3.23	2.38	122.4	82.0	60.5
12H46BS	1 1/2	40	-	1 1/2-11	2	4.82	3.23	2.38	122.4	82.0	60.5
20H51	2 1/2	50	2-11 1/2	-	2	5.55	4.11	3.75	141.0	104.4	95.3
20H51BS	2 1/2	50	-	2-11	2	5.55	4.11	3.75	141.0	104.4	95.3
20H56	2 1/2	50	2 1/2-8	-	2	6.14	4.11	3.75	156.0	104.4	95.3
20H56BS	2 1/2	50	-	2 1/2-11	2	6.14	4.11	3.75	156.0	104.4	95.3
20H61	2 1/2	50	3-8	-	2	7.00	4.11	4.00	177.8	104.4	101.6
20H61BS	2 1/2	50	-	3-11	2	7.00	4.11	4.00	177.8	104.4	101.6

A=Overall Length, B=Maximum Diameter

* ISO 7241-1 Series B does not include 1-1/4 inch body size couplings; therefore, Series 10HK is not covered by this standard

To obtain connected length of coupling, add dimensions A (Fig. 2) and E (Fig. 4) together.

HK Series (Steel)

ISO 7241-1 B Interchange

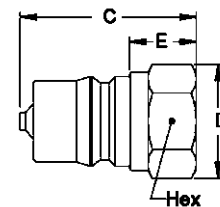

Figure 3

Plugs (Male)

Part Number HK1-8 Series	Body Size (in)	ISO Size (mm)	Thread Size (Female)			Fig.	Dimensions							
			NPTF	BSPP	SAE		C (in)	D (in)	E (in)	Hex (in)	C (mm)	D (mm)	E (mm)	Hex (mm)
1K11	1/8	5	1/8-27	-	-	3	1.26	0.65	0.44	0.56	32.0	16.5	11.2	14.2
1K4	1/8	5	-	-	7/16-20	3	1.41	0.79	0.59	0.69	35.8	20.1	15.0	17.5
2K16	1/4	6.3	1/4-18	-	-	3	1.52	0.87	0.56	0.75	38.6	22.1	14.2	19.1
2K16BS	1/4	6.3	-	1/4-19	-	3	1.52	0.87	0.56	0.75	38.6	22.1	14.2	19.1
2K6	1/4	6.3	-	-	9/16-18	3	1.66	1.01	0.70	0.88	42.2	25.7	17.8	22.4
3K21	3/8	10	3/8-18	-	-	3	1.76	1.01	0.61	0.88	44.7	25.7	15.5	22.4
3K21BS	3/8	10	-	3/8-19	-	3	1.76	1.01	0.61	0.88	44.7	25.7	15.5	22.4
3K8	3/8	10	-	-	3/4-16	3	1.94	1.15	0.79	1.00	49.3	29.2	20.1	25.4
4KP26	1/2	12.5	1/2-14	-	-	3	2.03	1.30	0.76	1.13	51.6	33.0	19.3	28.7
4KP26BS	1/2	12.5	-	1/2-14	-	3	2.03	1.30	0.76	1.13	51.6	33.0	19.3	28.7
4KP10	1/2	12.5	-	-	7/8-14	3	2.11	1.37	0.84	1.19	53.6	34.8	21.3	30.2
6KP31	3/4	20	3/4-14	-	-	3	2.36	1.52	0.71	1.31	59.9	38.6	18.0	33.3
6KP31BS	3/4	20	-	3/4-14	-	3	2.36	1.52	0.71	1.31	59.9	38.6	18.0	33.3
6KP12	3/4	20	-	-	1 1/16-12	3	2.54	1.59	0.89	1.38	64.5	40.4	22.6	35.1
8KP36	1	25	1-11 1/2	-	-	3	2.85	1.88	0.97	1.63	72.4	47.8	24.6	41.4
8KP36BS	1	25	-	1-11	-	3	2.85	1.88	0.97	1.63	72.4	47.8	24.6	41.4
8KP16	1	25	-	-	1 1/16-12	3	2.85	2.17	0.97	1.88	72.4	55.1	24.6	47.8

C=Overall Length, D=Maximum Diameter, E=Exposed Length when Connected
To obtain connected length of coupling, add dimensions A (Fig. 1) and E (Fig. 3) together.

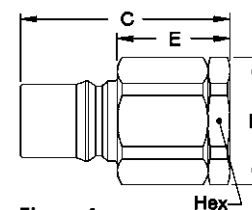

Figure 4

Plugs (Male)

Part Number HK10/12/20 Series	Body Size (in)	ISO Size (mm)	Thread Size (Female)		Fig.	Dimensions							
			NPTF	BSPP		C (in)	D (in)	E (in)	Hex (in)	C (mm)	D (mm)	E (mm)	Hex (mm)
10K41*	1 1/4	-	1 1/4-11 1/2	-	4	4.25	2.74	2.33	2.38	108.0	69.6	59.2	60.5
10K41BS*	1 1/4	-	-	1 1/4-11	4	4.25	2.74	2.33	2.38	108.0	69.6	59.2	60.5
12K41	1 1/2	40	1 1/4-11 1/2	-	4	4.76	2.74	2.67	2.38	120.9	69.6	67.8	60.5
12K41BS	1 1/2	40	-	1 1/4-11	4	4.76	2.74	2.67	2.38	120.9	69.6	67.8	60.5
12K46	1 1/2	40	1 1/2-11 1/2	-	4	4.76	2.74	2.67	2.38	120.9	69.6	67.8	60.5
12K46BS	1 1/2	40	-	1 1/2-11	4	4.76	2.74	2.67	2.38	120.9	69.6	67.8	60.5
20K51	2 1/2	60	2-11 1/2	-	4	5.49	4.33	2.97	3.75	139.4	110.0	75.4	95.3
20K51BS	2 1/2	60	-	2-11	4	5.49	4.33	2.97	3.75	139.4	110.0	75.4	95.3
20K56	2 1/2	60	2 1/2-8	-	4	6.08	4.33	3.56	3.75	154.4	110.0	90.4	95.3
20K56BS	2 1/2	60	-	2 1/2-11	4	6.08	4.33	3.56	3.75	154.4	110.0	90.4	95.3
20K61	2 1/2	60	3-8	-	4	6.94	4.62	4.42	4.00	176.3	117.3	112.3	101.6
20K61BS	2 1/2	60	-	3-11	4	6.94	4.62	4.42	4.00	176.3	117.3	112.3	101.6

C=Overall Length, D=Maximum Diameter, E=Exposed Length when Connected
* ISO 7241-1 Series B does not include 1-1/4 inch body size couplings; therefore, Series 10HK is not covered by this standard
To obtain connected length of coupling, add dimensions A (Fig. 2) and E (Fig. 4) together.

Dust Plugs and Dust Caps Accessories

Coupling Series	Plug Dust Cap Part No.		Socket Dust Plug Part No.	
	Metal	Vinyl	Metal	Vinyl
1HK	XPDC1HK*	XPPDC1HK	SDC1HK*	XPSDC1HK
2HK	XPDC2HK*	XPPDC2HK	SDC2HK*	XPSDC2HK
3HK	XPDC3HK*	XPPDC3HK	SDC3HK*	XPSDC3HK
4HK	XPDC4HK**	XPPDC4HK(RD)***	SDC4HK**	XPSDC4HK(RD)***
6HK	XPDC6HK**	XPPDC6HK(RD)***	SDC6HK**	XPSDC6HK(RD)***
8HK	XPDC8HK**	XPPDC8HK(RD)***	SDC8HK**	XPSDC8HK(RD)***
12HK	XPDC12HK*		SDC12HK*	
20HK	XPDC20HK*		SDC20HK*	

*Brass **Aluminum ***Offered in red by adding RD to end of part number



HK Series (Brass)

ISO 7241-1 B Interchange

Fluid transfer & Hydraulic application



Product Features

- Meets dimensional requirements to ISO standard 7241-1 Series B
- Brass construction with stainless steel springs for greater corrosion resistance and fluid compatibility
- Self-sealing poppet valves provide excellent high and low pressure sealing
- Standard seal material: Nitrile (NBR)
- Seal options available in PTFE, Neoprene, FKM, EPDM, and Kalrez®

Physical Characteristics

Series	Body Size (in)	ISO Size (mm)	Nominal Flow Diameter (mm)	Max. Operating Pressure				Rated Flow*		Air Inclusion cc. max.	Fluid Loss cc. max.
				Non hazardous liquids & gases Group 2		Hazardous liquids & gases Group 1		(lpm)	(gpm)		
1HK	1/8	5	4.4	207	3,000	207	3,000	3	0.8	0.6	0.5
2HK	1/4	6.3	5.9	186	2,700	186	2,700	12	3	1.2	0.9
3HK	3/8	10	7.8	152	2,200	152	2,200	23	6	2.9	2.1
4HK	1/2	12.5	10	155	2,250	155	2,250	45	12	3.6	3.5
6HK	3/4	20	17	138	2,000	138	2,000	100	26	11.5	9.3
8HK	1	25	19.6	103	1,500	103	1,500	189	50	18.0	16.9
10HK	1 1/4**	—	26.7	83	1,200	37	537	288	76	48.0	48.0
12HK	1 1/2	40	35.1	104	1,500	29	421	375	99	91.3	91.3
20HK	2 1/2	50	46	49	700	21	305	757	200	209.9	209.9

* For questions related to vacuum please contact Danfoss.

** No ISO Standard available for the 10HK

Applications & Markets

- Agriculture
- Hydraulic Tool
- General Industry
- Construction
- Fluid Transfer
- Chemical
- Oil and Gas
- Transportation
- Food and Beverage
- Trucks
- Nuclear

Danfoss Hansen HK brass is a general purpose industrial interchange coupling available in valved or non-valved designs, offered in brass for excellent corrosion resistance in rugged applications where stainless steel is unacceptable. The HK Series features a ball latch mechanism with automatic self-sealing poppet valves.

European Pressure Equipment Directive

Couplings with nominal diameters up to and including 25 mm are designed and manufactured under Article 4.3 of the European Pressure Equipment Directive 2014/68/EU. Couplings with nominal diameters greater than 25 mm are designed and manufactured in accordance with stipulations of Module A of the European Pressure Equipment Directive 2014/68/EU. They should not be used to convey unstable gases.

Group 1 = Hazardous media / Group 2 = Other media

Flow Data



Seal Elastomer Data*

Seal Elastomer	Max. Operation Temperature Range
Nitrile (NBR)	-40°C to +121°C / 40°F to +250°F
Neoprene	-54°C to +100°C / -65°F to +212°F
EPDM	-54°C to +149°C / -65°C to +300°F
FKM	-29°C to +204°C / -15°F to +400°F

* For reference only, based on Danfoss recommended temperatures.

Contact Danfoss technical support for further information on fluid compatibility.

HK Series (Brass)

ISO 7241-1 B Interchange

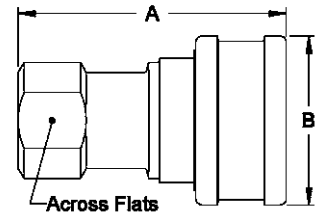

Figure 1

Sockets (Female)

Part Number HK1-8 Series	Body Size	ISO Size	Thread Size (Female)		Fig.	Dimensions					
	(in)	(mm)	NPTF	BSPP		A (in)	B (in)	Across Flats (in)	A (mm)	B (mm)	Across Flats (mm)
B1H11	1/8	5	1/8-27	-	1	1.91	0.98	0.56	48.5	24.9	14.2
B2H16	1/4	6.3	1/4-18	-	1	2.26	1.14	0.75	57.4	29.0	19.1
B2H16BS	1/4	6.3	-	1/4-19	1	2.31	1.14	0.75	58.7	29.0	19.1
B3H21	3/8	10	3/8-18	-	1	2.56	1.42	0.88	65.0	36.1	22.4
B3H21BS	3/8	10	-	3/8-19	1	2.56	1.42	0.88	65.0	36.1	22.4
B4HP26	1/2	12.5	1/2-14	-	1	2.96	1.86	1.13	75.2	47.2	28.7
B4HP26BS	1/2	12.5	-	1/2-14	1	2.96	1.86	1.13	75.2	47.2	28.7
B6HP31	3/4	20	3/4-14	-	1	3.48	2.22	1.31	88.4	56.4	33.3
B6HP31BS	3/4	20	-	3/4-14	1	3.48	2.22	1.31	88.4	56.4	33.3
B8HP36	1	25	1-11 1/2	-	1	4.13	2.61	1.75	104.9	66.3	44.5
B8HP36BS	1	25	-	1-11	1	4.13	2.61	1.75	104.9	66.3	44.5

A=Overall Length, B=Maximum Diameter

To obtain connected length of coupling, add dimensions A (Fig. 1) and E (Fig. 3) together.

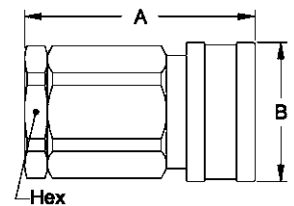

Figure 2

Sockets (Female)

Part Number HK10/12/20 Series	Body Size	ISO Size	Thread Size (Female)		Fig.	Dimensions					
	(in)	(mm)	NPTF	BSPP		A (in)	B (in)	Hex (in)	A (mm)	B (mm)	Hex (mm)
B10H41*	1 1/4	-	1 1/4-11 1/2	-	2	4.51	2.73	2.38	114.6	69.3	60.5
B12H41	1 1/2	40	1 1/4-11 1/2	-	2	4.82	3.23	2.38	122.4	82.0	60.5
B12H41BS	1 1/2	40	-	1 1/4-11	2	4.82	3.23	2.38	122.4	82.0	60.5
B12H46	1 1/2	40	1 1/2-11	-	2	4.82	3.23	2.38	122.4	82.0	60.5
B12H46BS	1 1/2	40	-	1 1/2-11	2	4.82	3.23	2.38	122.4	82.0	60.5
B20H51	2 1/2	50	2-11 1/2	-	2	5.55	4.11	3.75	141.0	104.4	95.3
B20H51BS	2 1/2	50	-	2-11	2	5.55	4.11	3.75	141.0	104.4	95.3
B20H56	2 1/2	50	2 1/2-8	-	2	6.14	4.11	3.75	156.0	104.4	95.3
B20H56BS	2 1/2	50	-	2 1/2-11	2	6.14	4.11	3.75	156.0	104.4	95.3
B20H61	2 1/2	50	3-8	-	2	7.00	4.11	4.00	177.8	104.4	101.6
B20H61BS	2 1/2	50	-	3-11	2	7.00	4.11	4.00	177.8	104.4	101.6

A=Overall Length, B=Maximum Diameter

* ISO 7241-1 Series B does not include 1-1/4 inch body size couplings; therefore, Series 10HK is not covered by this standard

To obtain connected length of coupling, add dimensions A (Fig. 2) and E (Fig. 4) together.

HK Series (Brass)

ISO 7241-1 B Interchange

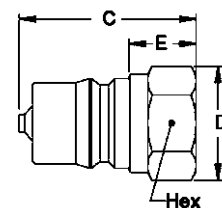

Figure 3

Plugs (Male)

Part Number HK1-8 Series	Body Size (in)	ISO Size (mm)	Thread Size (Female)		Fig.	Dimensions							
			NPTF	BSPP		C (in)	D (in)	E (in)	Hex (in)	C (mm)	D (mm)	E (mm)	Hex (mm)
B1K11	1/8	5	1/8-27	-	3	1.26	0.65	0.44	0.56	32.0	16.5	11.2	14.2
B2K16	1/4	6.3	1/4-18	-	3	1.52	0.87	0.56	0.75	38.6	22.1	14.2	19.1
B2K16BS	1/4	6.3	-	1/4-19	3	1.52	0.87	0.56	0.75	38.6	22.1	14.2	19.1
B3K21	3/8	10	3/8-18	-	3	1.76	1.01	0.61	0.88	44.7	25.7	15.5	22.4
B3K21BS	3/8	10	-	3/8-19	3	1.76	1.01	0.61	0.88	44.7	25.7	15.5	22.4
B4KP26	1/2	12.5	1/2-14	-	3	2.03	1.30	0.76	1.13	51.6	33.0	19.3	28.7
B4KP26BS	1/2	12.5	-	1/2-14	3	2.03	1.30	0.76	1.13	51.6	33.0	19.3	28.7
B6KP31	3/4	20	3/4-14	-	3	2.36	1.52	0.71	1.31	59.9	38.6	18.0	33.3
B6KP31BS	3/4	20	-	3/4-14	3	2.36	1.52	0.71	1.31	59.9	38.6	18.0	33.3
B8KP36	1	25	1-11 1/2	-	3	2.85	1.88	0.97	1.63	72.4	47.8	24.6	41.4
B8KP36BS	1	25	-	1-11	3	2.85	1.88	0.97	1.63	72.4	47.8	24.6	41.4

C=Overall Length, D=Maximum Diameter, E=Exposed Length when Connected
To obtain connected length of coupling, add dimensions A (Fig. 1) and E (Fig. 3) together.

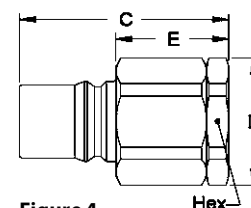

Figure 4

Plugs (Male)

Part Number HK10/12/20 Series	Body Size (in)	ISO Size (mm)	Thread Size (Female)		Fig.	Dimensions							
			NPTF	BSPP		C (in)	D (in)	E (in)	Hex (in)	C (mm)	D (mm)	E (mm)	Hex (mm)
B10K41*	1 1/4	-	1 1/4-11 1/2	-	4	4.25	2.74	2.33	2.38	108.0	69.6	59.2	60.5
B12K41	1 1/2	40	1 1/4-11 1/2	-	4	4.76	2.74	2.67	2.38	120.9	69.6	67.8	60.5
B12K41BS	1 1/2	40	-	1 1/4-11	4	4.76	2.74	2.67	2.38	120.9	69.6	67.8	60.5
B12K46	1 1/2	40	1 1/2-11 1/2	-	4	4.76	2.74	2.67	2.38	120.9	69.6	67.8	60.5
B12K46BS	1 1/2	40	-	1 1/2-11	4	4.76	2.74	2.67	2.38	120.9	69.6	67.8	60.5
B20K51	2 1/2	50	2-11 1/2	-	4	5.49	4.33	2.97	3.75	139.4	110.0	75.4	95.3
B20K51BS	2 1/2	50	-	2-11	4	5.49	4.33	2.97	3.75	139.4	110.0	75.4	95.3
B20K56	2 1/2	50	2 1/2-8	-	4	6.08	4.33	3.56	3.75	154.4	110.0	90.4	95.3
B20K56BS	2 1/2	50	-	2 1/2-11	4	6.08	4.33	3.56	3.75	154.4	110.0	90.4	95.3
B20K61	2 1/2	50	3-8	-	4	6.94	4.62	4.42	4.00	176.3	117.3	112.3	101.6
B20K61BS	2 1/2	50	-	3-11	4	6.94	4.62	4.42	4.00	176.3	117.3	112.3	101.6

C=Overall Length, D=Maximum Diameter, E=Exposed Length when Connected
* ISO 7241-1 Series B does not include 1-1/4 inch body size couplings; therefore, Series 10HK is not covered by this standard
To obtain connected length of coupling, add dimensions A (Fig. 2) and E (Fig. 4) together.

Dust Plugs and Dust Caps Accessories

Coupling Series	Plug Dust Cap Part No.		Socket Dust Plug Part No.	
	Metal	Vinyl	Metal	Vinyl
1HK	XPDC1HK*	XPPDC1HK	SDC1HK*	XPSPDC1HK
2HK	XPDC2HK*	XPPDC2HK	SDC2HK*	XPSPDC2HK
3HK	XPDC3HK*	XPPDC3HK	SDC3HK*	XPSPDC3HK
4HK	XPDC4HK**	XPPDC4HK(RD)***	SDC4HK**	XPSPDC4HK(RD)***
6HK	XPDC6HK**	XPPDC6HK(RD)***	SDC6HK**	XPSPDC6HK(RD)***
8HK	XPDC8HK**	XPPDC8HK(RD)***	SDC8HK**	XPSPDC8HK(RD)***
12HK	XPDC12HK*		SDC12HK*	
20HK	XPDC20HK*		SDC20HK*	

*Brass **Aluminum ***Offered in red by adding RD to end of part number



HK Series (Stainless Steel)

ISO 7241-1 B Interchange

Fluid transfer & Hydraulic application



Product Features

- Meets dimensional requirements to ISO standard 7241-1 Series B
- 303/316 Stainless steel construction for greater corrosion resistance and fluid compatibility
- Self-sealing poppet valves provide excellent high and low pressure sealing
- Standard body material: 303 or 316 Stainless Steel
- Standard seal material: Nitrile (NBR)
- Seal options available in PTFE, Neoprene, FKM, EPDM, and Kalrez®

Physical Characteristics

Series	Body Size (in)	ISO Size (mm)	Nominal Flow Diameter (mm)	Max. Operating Pressure				Rated Flow*		Air Inclusion cc. max.	Fluid Loss cc. max.
				Non hazardous liquids & gases Group 2		Hazardous liquids & gases Group 1		(lpm)	(gpm)		
1HK	1/8	5	4.4	344	5,000	344	5,000	3	0.8	0.6	0.5
2HK	1/4	6.3	5.9	255	3,700	255	3,700	12	3	1.2	0.9
3HK	3/8	10	7.8	255	3,700	255	3,700	23	6	2.9	2.1
4HK	1/2	12.5	10	293	4,250	293	4,250	45	12	3.6	3.5
6HK	3/4	20	17	242	3,500	242	3,500	100	26	11.5	9.3
8HK	1	25	19.6	207	3,000	207	3,000	189	50	18.0	16.9
10HK	1 1/4**	—	26.7	118	1,700	37	537	288	76	48.0	48.0
12HK	1 1/2	40	35.1	152	2,200	29	421	375	99	91.3	91.3
20HK	2 1/2	50	46	104	1,500	21	305	757	200	209.9	209.9

* For questions related to vacuum please contact Danfoss.

** No ISO Standard available for the 10HK

Applications & Markets

- Agriculture
- Hydraulic Tool
- General Industry
- Construction
- Fluid Transfer
- Transportation
- Military
- Law Enforcement/Rescue
- Chemical
- Oil and Gas
- Consumer Products
- HVAC
- Food and Beverage
- Trucks
- Aerospace
- Medical

Danfoss Hansen HK stainless steel coupling is a general purpose industrial interchange coupling available in valved or non-valved designs, offered in 303/316 grades of stainless steel for excellent corrosion resistance in rugged applications. The HK Series features a ball latch mechanism with automatic self-sealing poppet valves.

European Pressure Equipment Directive

Couplings with nominal diameters up to and including 25 mm are designed and manufactured under Article 4.3 of the European Pressure Equipment Directive 2014/68/EU. Couplings with nominal diameters greater than 25 mm are designed and manufactured in accordance with stipulations of Module A of the European Pressure Equipment Directive 2014/68/EU. They should not be used to convey unstable gases.

Group 1 = Hazardous media / Group 2 = Other media

Flow Data

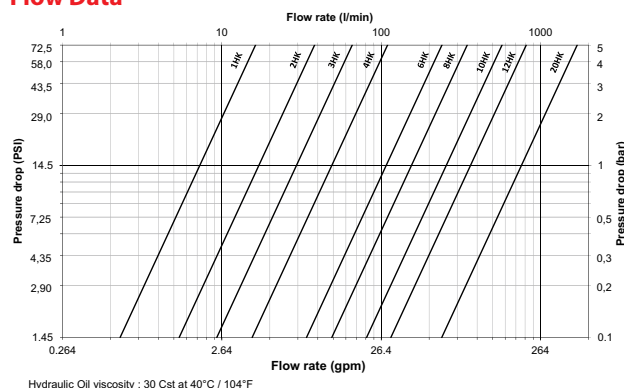

Seal Elastomer Data*

Seal Elastomer	Max. Operation Temperature Range
Nitrile (NBR)	-40°C to +121°C / 40°F to +250°F
Neoprene	-54°C to +100°C / -65°F to +212°F
EPDM	-54°C to +149°C / -65°C to +300°F
FKM	-29°C to +204°C / -15°F to +400°F

*For reference only, based on Danfoss recommended temperatures.

Contact Danfoss technical support for further information on fluid compatibility.

HK Series (Stainless Steel)

ISO 7241-1 B Interchange

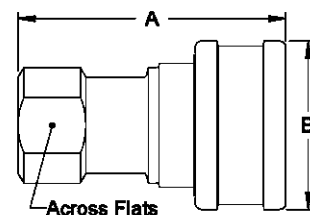

Figure 1

Sockets (Female)

Part Number HK1-8 Series 303 Stainless Steel	316 Stainless Steel	Body Size (in)	ISO Size (in)	Thread Size (Female)			Fig. Dimensions						
				NPTF	BSPP	SAE	A (in)	B (in)	Across Flats (in)	A (mm)	B (mm)	Across Flats (mm)	
LL1H11	ML1H11	1/8	5	1/8-27	-	-	1	1.91	0.98	0.56	48.5	24.9	14.2
LL1H4	-	1/8	5	-	-	7/16-20	1	2.06	0.98	0.69	52.3	24.9	17.5
LL2H16	ML2H16	1/4	6.3	1/4-18	-	-	1	2.26	1.14	0.75	57.4	29.0	19.1
LL2H16BS	ML2H16BS	1/4	6.3	-	1/4-19	-	1	2.31	1.14	0.75	58.7	29.0	19.1
LL2H6	-	1/4	6.3	-	-	9/16-18	1	2.40	1.14	0.88	61.0	29.0	22.4
LL3H21	ML3H21	3/8	10	3/8-18	-	-	1	2.56	1.42	0.88	65.0	36.1	22.4
LL3H21BS	ML3H21BS	3/8	10	-	3/8-19	-	1	2.56	1.42	0.88	65.0	36.1	22.4
LL3H8	-	3/8	10	-	-	3/4-16	1	2.74	1.42	1.00	69.6	36.1	25.4
LL4HP26	ML4HP26	1/2	12.5	1/2-14	-	-	1	2.96	1.86	1.13	75.2	47.2	28.7
LL4HP26BS	ML4HP26BS	1/2	12.5	-	1/2-14	-	1	2.96	1.86	1.13	75.2	47.2	28.7
LL4HP10	-	1/2	12.5	-	-	7/8-14	1	3.05	1.86	1.25	77.5	47.2	31.8
LL6HP31	ML6HP31	3/4	20	3/4-14	-	-	1	3.48	2.22	1.31	88.4	56.4	33.3
LL6HP31BS	ML6HP31BS	3/4	20	-	3/4-14	-	1	3.48	2.22	1.31	88.4	56.4	33.3
LL6HP12	-	3/4	20	-	-	11/16-12	1	3.67	2.22	1.38	93.2	56.4	35.1
LL8HP36	ML8HP36	1	25	1-11 1/2	-	-	1	4.13	2.61	1.75	104.9	66.3	44.5
LL8HP36BS	ML8HP36BS	1	25	-	1-11	-	1	4.13	2.61	1.75	104.9	66.3	44.5
LL8HP16	-	1	25	-	-	1 1/16-12	1	4.13	2.61	1.88	104.9	66.3	47.8

A=Overall Length, B=Maximum Diameter

To obtain connected length of coupling, add dimensions A (Fig. 1) and E (Fig. 3) together.

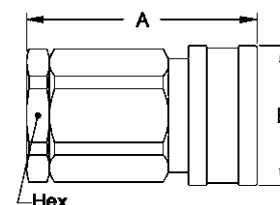

Figure 2

Sockets (Female)

Part Number HK10/12/20 Series 303 Stainless Steel	Body Size (in)	ISO Size (mm)	Thread Size (Female)		Fig.	Dimensions					
			NPTF	BSPP		A (in)	B (in)	Hex (in)	A (mm)	B (mm)	Hex (mm)
LL10H41*	1 1/4	-	1 1/4-11 1/2	-	2	4.51	2.73	2.38	114.6	69.3	60.5
LL10H41BS*	1 1/4	-	-	1 1/4-11	2	4.51	2.73	2.38	114.6	69.3	60.5
LL12H41	1 1/2	40	1 1/4-11 1/2	-	2	4.82	3.23	2.38	122.4	82.0	60.5
LL12H41BS	1 1/2	40	-	1 1/4-11	2	4.82	3.23	2.38	122.4	82.0	60.5
LL12H46	1 1/2	40	1 1/2-11 1/2	-	2	4.82	3.23	2.38	122.4	82.0	60.5
LL12H46BS	1 1/2	40	-	1 1/2-11	2	4.82	3.23	2.38	122.4	82.0	60.5
LL20H51	2 1/2	50	2-11 1/2	-	2	5.55	4.11	3.75	141.0	104.4	95.3
LL20H51BS	2 1/2	50	-	2-11	2	5.55	4.11	3.75	141.0	104.4	95.3
LL20H56	2 1/2	50	2 1/2-8	-	2	6.14	4.11	3.75	156.0	104.4	95.3
LL20H56BS	2 1/2	50	-	2 1/2-11	2	6.14	4.11	3.75	156.0	104.4	95.3
LL20H61	2 1/2	50	3-8	-	2	7.00	4.11	4.00	177.8	104.4	101.6
LL20H61BS	2 1/2	50	-	3-11	2	7.00	4.11	4.00	177.8	104.4	101.6

A=Overall Length, B=Maximum Diameter

* ISO 7241-1 Series B does not include 1-1/4 inch body size couplings; therefore, Series 10HK is not covered by this standard.

To obtain connected length of coupling, add dimensions A (Fig. 2) and E (Fig. 4) together.

HK Series (Stainless Steel)

ISO 7241-1 B Interchange

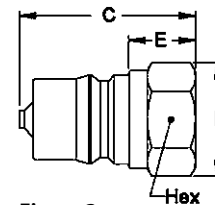

Figure 3

Plugs (Male)

Part Number HK1-8 Series 303	316	Body Size (in)	ISO Size (mm)	Thread Size (Female)			Fig.	Dimensions							
				NPTF	BSPB	SAE		C (in)	D (in)	E (in)	Hex (in)	C (mm)	D (mm)	E (mm)	Hex (mm)
LL1K11	ML1K11	1/8	5	1/8-27	-	-	3	1.26	0.65	0.44	0.56	32.0	16.5	11.2	14.2
LL1K4	-	1/8	5	-	-	7/16-20	3	1.41	0.79	0.59	0.69	35.8	20.1	15.0	17.5
LL2K16	ML2K16	1/4	6.3	1/4-18	-	-	3	1.52	0.87	0.56	0.75	38.6	22.1	14.2	19.1
LL2K16BS	ML2K16BS	1/4	6.3	-	1/4-19	-	3	1.52	0.87	0.56	0.75	38.6	22.1	14.2	19.1
LL2K6	-	1/4	6.3	-	-	9/16-18	3	1.66	1.01	0.70	0.88	42.2	25.7	17.8	22.4
LL3K21	ML3K21	3/8	10	3/8-18	-	-	3	1.76	1.01	0.61	0.88	44.7	25.7	15.5	22.4
LL3K21BS	ML3K21BS	3/8	10	-	3/8-19	-	3	1.76	1.01	0.61	0.88	44.7	25.7	15.5	22.4
LL3K8	-	3/8	10	-	-	3/4-16	3	1.94	1.15	0.79	1.00	49.3	29.2	20.1	25.4
LL4KP26	ML4KP26	1/2	12.5	1/2-14	-	-	3	2.03	1.30	0.76	1.13	51.6	33.0	19.3	28.7
LL4KP26BS	ML4KP26BS	1/2	12.5	-	1/2-14	-	3	2.03	1.30	0.76	1.13	51.6	33.0	19.3	28.7
LL4KP10	-	1/2	12.5	-	-	7/8-14	3	2.11	1.37	0.84	1.19	53.6	34.8	21.3	30.2
LL6KP31	ML6KP31	3/4	20	3/4-14	-	-	3	2.36	1.52	0.71	1.31	59.9	38.6	18.0	33.3
LL6KP31BS	ML6KP31BS	3/4	20	-	3/4-14	-	3	2.36	1.52	0.71	1.31	59.9	38.6	18.0	33.3
LL6KP12	-	3/4	20	-	-	1 1/8-12	3	2.54	1.59	0.89	1.38	64.5	40.4	22.6	35.1
LL8KP36	ML8KP36	1	25	1-11 1/2	-	-	3	2.85	1.88	0.97	1.63	72.4	47.8	24.6	41.4
LL8KP36BS	ML8KP36BS	1	25	-	1-11	-	3	2.85	1.88	0.97	1.63	72.4	47.8	24.6	41.4
LL8KP16	-	1	25	-	-	1 1/8-12	3	2.85	2.17	0.97	1.88	72.4	55.1	24.6	47.8

C=Overall Length, D=Maximum Diameter, E=Exposed Length when Connected
To obtain connected length of coupling, add dimensions A (Fig. 1) and E (Fig. 3) together.

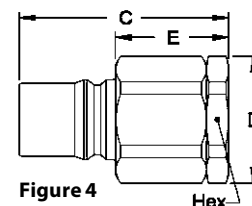

Figure 4

Plugs (Male)

Part Number HK10/12/20 Series 303 Stainless Steel	Body Size (in)	ISO Size (mm)	Thread Size (Female)		Fig.	Dimensions							
			NPTF	BSPB		C (in)	D (in)	E (in)	Hex (in)	C (mm)	D (mm)	E (mm)	Hex (mm)
LL10K41*	1 1/4	-	1 1/4-11 1/2	-	4	4.25	2.74	2.33	2.38	108.0	69.6	59.2	60.5
LL10K41BS*	1 1/4	-	-	1 1/4-11	4	4.25	2.74	2.33	2.38	108.0	69.6	59.2	60.5
LL12K41	1 1/2	40	1 1/4-11 1/2	-	4	4.76	2.74	2.67	2.38	120.9	69.6	67.8	60.5
LL12K41BS	1 1/2	40	-	1 1/4-11	4	4.76	2.74	2.67	2.38	120.9	69.6	67.8	60.5
LL12K46	1 1/2	40	1 1/2-11 1/2	-	4	4.76	2.74	2.67	2.38	120.9	69.6	67.8	60.5
LL12K46BS	1 1/2	40	-	1 1/2-11	4	4.76	2.74	2.67	2.38	120.9	69.6	67.8	60.5
LL20K51	2 1/2	50	2-11 1/2	-	4	5.49	4.33	2.97	3.75	139.4	110.0	75.4	95.3
LL20K51BS	2 1/2	50	-	2-11	4	5.49	4.33	2.97	3.75	139.4	110.0	75.4	95.3
LL20K56	2 1/2	50	2 1/2-8	-	4	6.08	4.33	3.56	3.75	154.4	110.0	90.4	95.3
LL20K56BS	2 1/2	50	-	2 1/2-11	4	6.08	4.33	3.56	3.75	154.4	110.0	90.4	95.3
LL20K61	2 1/2	50	3-8	-	4	6.94	4.62	4.42	4.00	176.3	117.3	112.3	101.6
LL20K61BS	2 1/2	50	-	3-11	4	6.94	4.62	4.42	4.00	176.3	117.3	112.3	101.6

C=Overall Length, D=Maximum Diameter, E=Exposed Length when Connected
* ISO 7241-1 Series B does not include 1-1/4 inch body size couplings; therefore, Series 10HK is not covered by this standard.
To obtain connected length of coupling, add dimensions A (Fig. 2) and E (Fig. 4) together.

Dust Plugs and Dust Caps Accessories

Coupling Series	Plug Dust Cap Part No.		Socket Dust Plug Part No.	
	Metal	Vinyl	Metal	Vinyl
1HK	XPDC1HK*	XPPDC1HK	SDC1HK*	XPSDC1HK
2HK	XPDC2HK*	XPPDC2HK	SDC2HK*	XPSDC2HK
3HK	XPDC3HK*	XPPDC3HK	SDC3HK*	XPSDC3HK
4HK	XPDC4HK**	XPPDC4HK(RD)***	SDC4HK**	XPSDC4HK(RD)***
6HK	XPDC6HK**	XPPDC6HK(RD)***	SDC6HK**	XPSDC6HK(RD)***
8HK	XPDC8HK**	XPPDC8HK(RD)***	SDC8HK**	XPSDC8HK(RD)***
12HK	XPDC12HK*	-	SDC12HK*	-
20HK	XPDC20HK*	-	SDC20HK*	-

*Brass **Aluminum ***Offered in red by adding RD to end of part number



HK special configuration

LL4HKP26

Fluid transfer & Hydraulic application



The Danfoss Hansen LL4HKP26 series is a special HK series designed for food and beverage applications. It was designed based on the HK series in stainless steel.

Besides the size difference between the 2HKGL series in 1/4" and this coupling made in 1/2" version: the LL4HKP26 has the same plug configuration.

The plug has a flat face, and the socket has a long valve nose. It is additionally, mainly mounted on stainless steel tanks to prevent accidental opening of the valves.

Product features

- Stainless steel construction
- Size 1/2"
- Prevention of accidental opening of the plug valve

Application

- Food and beverage application
- Specific application

Physical Characteristics

Working Pressure		Rated Flow		Air Inclusion	Fluid loss
(bar)	(psi)	(lpm)	(gpm)	cc.max.	cc.max.
293	4250	45,42	12	3,6	3,5

Dimensions

Body Size (in)	Nominal Flow Diameter (mm)	Socket part number	Plug part number	End-connection (female)	Socket dimensions (Fig. 1)		Plug dimensions (Fig. 2)		
					A (mm)	B (mm)	C (mm)	D (mm)	Hex (in)
1/2	10	LL4HP26S13	LL4KP26S10	G1/2	74,7	47,2	46,9	23,5	1 1/8

Dust plugs and caps

Coupling Series	Plug Dust Cap Part No.		Socket Dust Plug Part No.	
	Metal	Vinyl	Metal	Vinyl
4HK	XPDC4HK**	XPPDC4HK(RD)***	SDC4HK**	XPSDC4HK(RD)***

*Brass **Aluminum ***Offered in red by adding RD to end of part number

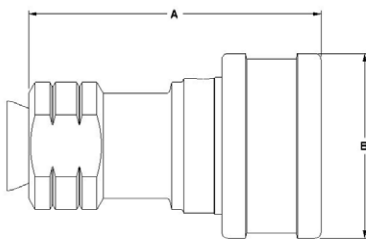

Figure 1 : Socket part

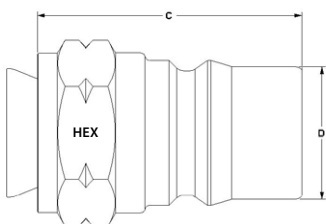
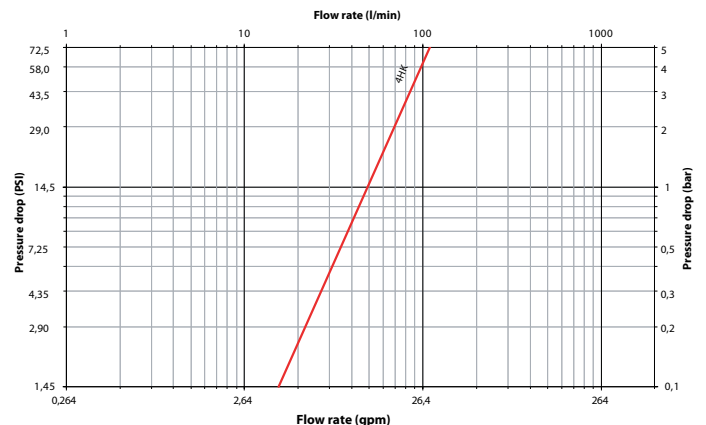

Figure 2 : Plug part

Flow Data



Hydraulic Oil viscosity : 30 Cst at 40°C / 104°F

HK special configuration

LL2HK-MS

Fluid transfer & Hydraulic application



Danfoss Hansen LL2HK-MS series is a special HK series made for specific application. This coupling is made of 303 stainless steel. The locking mechanism is push/pull. This specific coupling has been made for testing ground equipment for aerospace application. It was created based on the HK series (stainless steel). It is a unique profile which is not interchangeable with the 2HK series.

Product features

- Stainless steel construction
- Size 1/4"
- Proprietary profile

Application

- Hydraulic application
- Aerospace industry
- Specific application

Physical Characteristics

Working Pressure		Rated Flow		Air Inclusion	Fluid loss
(bar)	(psi)	(lpm)	(gpm)	cc.max.	cc.max.
255	3700	11,36	3	1,2	0,9

Dimensions

Body Size (in)	Nominal Flow Diameter (mm)	Socket part number	Plug part number	End-connection (female)	Socket dimensions (Fig. 1)		Plug dimensions (Fig. 2)		
					A (mm)	B (mm)	C (mm)	D (mm)	Hex (mm)
1/4	5,9	LL2H8MS	LL2K6/MS1	3/4 – 16 UNF	49,9	28,9	44,7	20,6	12,7

Dust plugs and caps

Coupling Series	Plug Dust Cap Part No.		Socket Dust Plug Part No.	
	Metal	Vinyl	Metal	Vinyl
2HK	XPDC2HK*	XPPDC2HK	SDC2HK*	XPSC2HK

*Brass

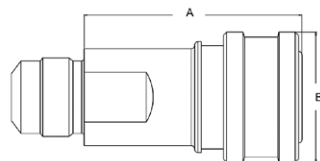

Figure 1: Socket part

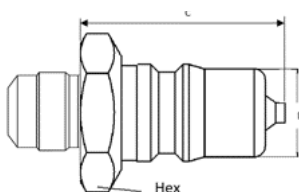
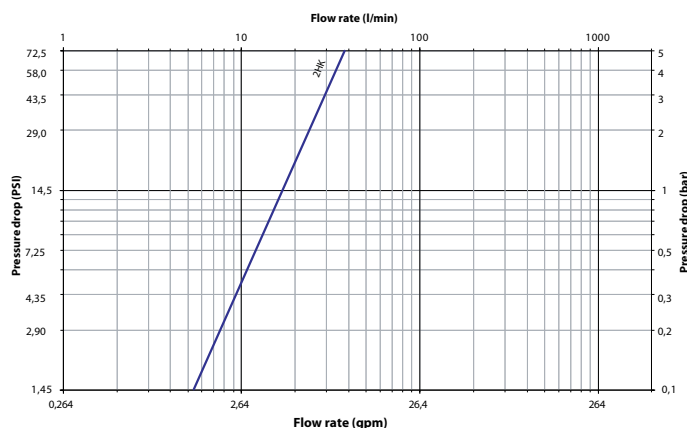

Figure 2: Plug part

Flow Data



Hydraulic Oil viscosity : 30 Cst at 40°C / 104°F

HKFR Series

ISO 7241-1 BOP

Fluid transfer & Hydraulic application

Danfoss Hansen HKFR Series is a quick disconnect hydraulic coupling for hazardous Blow Out Preventer (BOP) service in the Oil and Gas Industry. The HKFR Series meets or exceeds the ISO 7241-1 B standard.



Product Features

- BOP designation and red color is marked on the Socket/Female and Plug/Male halves
- Sleeve lock is standard
- Lloyd's Register Certification
- Meets or exceeds ISO 7241-1 Series B standard
- Utilizes HK Series dust caps and dust plugs
- Standard body material: 316 stainless steel, zinc trivalent plated steel
- Standard seal material: Nitrile (NBR)

Physical Characteristics

Series	Body Size (in)	Max. Operating Pressure Connected		Min. Burst Pressure		Rated Flow		Fluid Loss cc. max
		(bar)	(psi)	(bar)	(psi)	(lpm)	(gpm)	
4HKFR	1/2	482	7,000	1,931	28,000	28	7.5	3.5
6HKFR	3/4	344	5,000	1,251	18,150	66	17.5	9.3
8HKFR	1	344	5,000	1,379	20,000	95	25	16.9
ML8HKFR	1	344	5,000	1,379	20,000	95	25	16.9

Applications & Markets

- Oil and gas

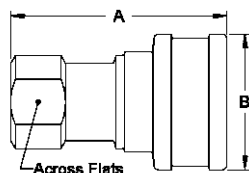

Figure 1

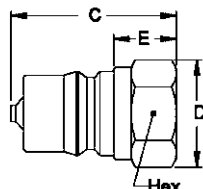

Figure 2

Lloyd's Register Certification

All of the above items carry a Lloyd's Registry Certificate for fire conditions stated in API 16D and EUB Directive 36. These parts meet the requirements that state couplings shall be capable of maintaining pressure when exposed to a 700°C (1,300°F) temperature for a five-minute period. Testing for this certification was conducted at the following pressures in the connected condition:

4HFR26/4KFR26:	3,000 PSI/206 BAR
6HFR31/6KFR31:	3,000 PSI/206 BAR
8HFR36/8KFR36:	4,000 PSI/275 BAR
ML8HFR36/ML8KFR36:	4,000 PSI/275 BAR

Female End Connections

Part Number	Coupling Type	Body Size	Thread	Fig.	Dimensions			A	B	Across Flats
					A	B	Across Flats			
					(in)	(in)	(in)	(mm)	(mm)	(mm)
4HFR26	Socket/Female	1/2	1/2-14 NPTF	1	2.96	1.86	1.13	75.2	47.2	28.7
6HFR31	Socket/Female	3/4	3/4-14 NPTF	1	3.48	2.22	1.31	88.4	56.4	33.3
8HFR36	Socket/Female	1	1-1 1/2 NPTF	1	4.13	2.61	1.75	104.9	66.3	44.5
ML8HFR36*	Socket/Female	1	1-1 1/2 NPTF	1	4.13	2.61	1.75	104.9	66.3	44.5

*Stainless Steel

Plugs/Males

Part Number	Coupling Type	Body Size	Thread	Fig.	Dimensions				C	D	E	Hex
					C	D	E	Hex				
					(in)	(in)	(in)	(in)	(mm)	(mm)	(mm)	(mm)
4KFR26	Plug/Male	1/2	1/2-14 NPTF	2	2.03	1.3	0.76	1.13	51.6	33.0	19.3	28.7
6KFR31	Plug/Male	3/4	3/4-14 NPTF	2	2.36	1.52	0.71	1.31	59.9	38.6	18.0	33.3
8KFR36	Plug/Male	1	1-1 1/2 NPTF	2	2.85	1.88	0.97	1.63	72.4	47.8	24.6	41.4
ML8KFR36*	Plug/Male	1	1-1 1/2 NPTF	2	2.85	1.88	0.97	1.63	72.4	47.8	24.6	41.4

*Stainless Steel

2HKIG/2HKIL Series

Fluid transfer & Hydraulic application

Danfoss Hansen 2HKIG/2HKIL Series stainless steel couplings can be used with various liquids and gases. They are functionally identical, but do not interchange. They can be used where it is necessary to avoid crossing lines.



Product Features

- Ball lock
- Proprietary interchange with all stainless steel construction
- Female/Socket halves available with 90° connections
- Standard seal material: Nitrile (NBR)
- Standard body material: Stainless steel

Physical Characteristics

Body Size (in)	Max. Operating Pressure Connected		Min. Burst Pressure		Rated Flow		All Inclusion	Fluid Loss
	(bar)	(psi)	(bar)	(psi)	(lpm)	(gpm)	cc. max.	cc. max.
1/4	103	1,500	412	6,000	8.3	2.2	2.2	1

Applications & Markets

- Chemical
- Food and Beverage
- Military
- Aerospace

Flow Data

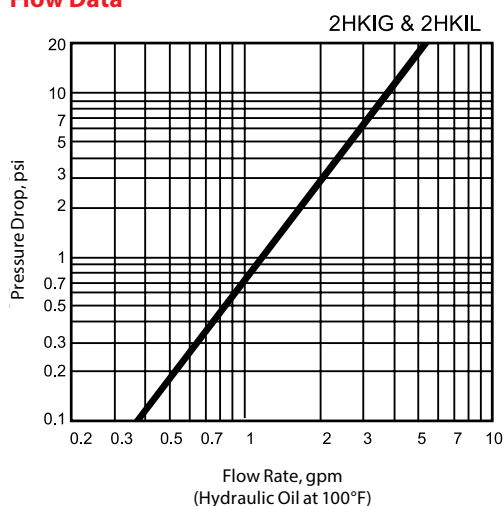

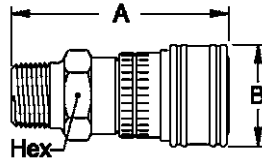

Figure 1

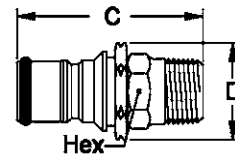

Figure 2

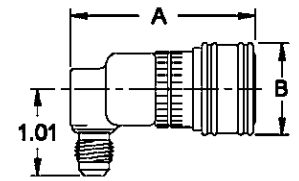

Figure 3

Male End Connections

Part Number	Coupling Type	Body Size	Thread	Fig.	Dimensions			A	B	Hex
					A	B	Hex			
					(in)	(in)	(in)	(mm)	(mm)	(mm)
2HIG10	Socket/Female	1/4	1/8-27 NPTF	1	2.18	1.06	0.81	55.4	26.9	20.6
2HIG15	Socket/Female	1/4	1/4-18 NPTF	1	2.31	1.06	0.81	58.7	26.9	20.6
2HIG20	Socket/Female	1/4	3/8-18 NPTF	1	2.31	1.06	0.81	58.7	26.9	20.6
2HIG720	Socket/Female	1/4	7/16-20 NPTF	1	2.27	1.06	0.81	57.7	26.9	20.6
2HIGLLRA720	Socket/Female	1/4	7/16-20 NPTF	3	2.09	1.06	—	53.1	26.9	—

Part Number	Coupling Type	Body Size	Thread	Fig.	Dimensions			C	D	Hex
					C	D	Hex			
					(in)	(in)	(in)	(mm)	(mm)	(mm)
2KIGF15	Plug/Male	1/4	1/4-18 NPTF	2	1.98	1.01	0.69	50.3	25.7	17.5
2KIGF20	Plug/Male	1/4	3/8-18 NPTF	2	1.98	1.01	0.69	50.3	25.7	17.5

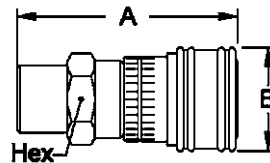

Figure 1

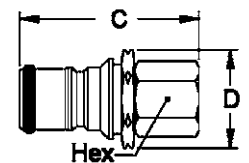

Figure 2

Female End Connections

Part Number	Coupling Type	Body Size	Thread	Fig.	Dimensions			A	B	Hex
					A	B	Hex			
					(in)	(in)	(in)	(mm)	(mm)	(mm)
2HIG11	Socket/Female	1/4	1/8-27 NPTF	1	2.18	1.06	0.81	55.4	26.9	20.6
2HIG16	Socket/Female	1/4	1/4-18 NPTF	1	2.26	1.06	0.81	57.4	26.9	20.6

Part Number	Coupling Type	Body Size	Thread	Fig.	Dimensions			C	D	Hex
					C	D	Hex			
					(in)	(in)	(in)	(mm)	(mm)	(mm)
2KIGF16	Plug/Male	1/4	1/4-18 NPTF	2	1.84	1.01	0.69	46.7	25.7	17.5
2KIGF720	Plug/Male	1/4	7/16-20 UNF	2	1.61	1.01	0.69	40.9	25.7	17.5
2KIGF	Plug/Male	1/4	5/8-18 UNF	2	1.17	1.01	0.68	29.7	25.7	17.3

2HKIL Series

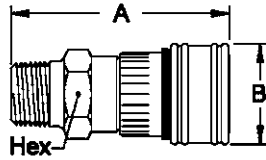

Figure 1

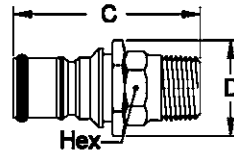

Figure 2

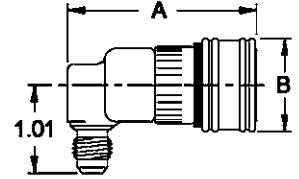

Figure 3

Male End Connections

Part Number	Coupling Type	Body Size	Thread	Fig.	Dimensions			A	B	Hex
					A	B	Hex			
					(in)	(in)	(in)	(mm)	(mm)	(mm)
2HIL10	Socket/Female	1/4	1/8-27 NPTF	1	2.18	1.06	0.81	55.4	26.9	20.6
2HIL15	Socket/Female	1/4	1/4-18 NPTF	1	2.31	1.06	0.81	58.7	26.9	20.6
2HIL20	Socket/Female	1/4	3/8-18 NPTF	1	2.31	1.06	0.81	58.7	26.9	20.6
2HIL720	Socket/Female	1/4	7/16-20 NPTF	1	2.27	1.06	0.81	57.7	26.9	20.6
2HILLRA720	Socket/Female	1/4	7/16-20 NPTF	3	2.09	1.06	—	53.1	26.9	—

Part Number	Coupling Type	Body Size	Thread	Fig.	Dimensions			C	D	Hex
					C	D	Hex			
					(in)	(in)	(in)	(mm)	(mm)	(mm)
2KILF15	Plug/Male	1/4	1/4-18 NPTF	2	1.98	1.01	0.69	50.3	25.7	17.5
2KILF20	Plug/Male	1/4	3/8-18 NPTF	2	1.98	1.01	0.69	50.3	25.7	17.5

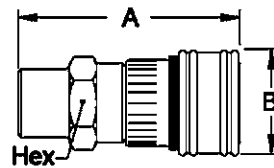

Figure 1

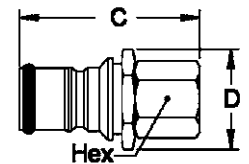

Figure 2

Female End Connections

Part Number	Coupling Type	Body Size	Thread	Fig.	Dimensions			A	B	Hex
					A	B	Hex			
					(in)	(in)	(in)	(mm)	(mm)	(mm)
2HIL11	Socket/Female	1/4	1/8-27 NPTF	1	2.18	1.06	0.81	55.4	26.9	20.6
2HIL16	Socket/Female	1/4	1/4-18 NPTF	1	2.26	1.06	0.81	57.4	26.9	20.6

Part Number	Coupling Type	Body Size	Thread	Fig.	Dimensions			C	D	Hex
					C	D	Hex			
					(in)	(in)	(in)	(mm)	(mm)	(mm)
2KILF16	Plug/Male	1/4	1/4 -18 NPTF	2	1.84	1.01	0.69	46.7	25.7	17.5
2KILF720	Plug/Male	1/4	7/16-20 UNF	2	1.61	1.01	0.69	40.9	25.7	17.5
2KILF	Plug/Male	1/4	5/8-18 UNF	2	1.17	1.01	0.68	29.7	25.7	17.3

FD48 Series Parker Bruning SM-250 Interchange

Fluid transfer & Hydraulic application

Danfoss Hansen FD48 Series coupling is poppet style quick disconnect coupling designed to interchange with Parker Bruning SM-250 couplings where excellent high and low pressure sealing is required. The FD48 operates with pressures up to 3,000 psi.



Product Features

- Self-sealing poppet valves provide excellent high and low pressure sealing
- PUSH-PULL™ ball latch design allows quick and easy connection and disconnection of fluid lines
- Heat-treated and plated steel for wear and corrosion resistance
- Standard seal material: Buna-N
- Standard body material: High resistance carbon steel with zinc trivalent plating

Applications & Markets

- Hydraulic and fluid transfer
- Agricultural equipment

Physical Characteristics

Body Size (in)	Max. Operating Pressure (bar) (psi)		Min. Burst Pressure Connected (bar) (psi)		Vacuum Connected Only (in./Hg)	Rated Flow (lpm) (gpm)		Air Inclusion cc. max.	Fluid Loss cc.max.
1/4	210	3,000	840	12,000	28	11	3	.50	1.10

Dimensions (Female NPT, Valved)

Part Number Buna-N	Coupling Type	Body Size	Port Size	Thread	Type	Fig.	Dimensions					
							A		B		Hex ①	
							mm	(in)	mm	(in)	mm	(in)
FD48-1002-04-04	Plug/Male	1/4	1/4	1/4-18	Female NPT	1	36.8	(1.45)	-	-	19.0	(.75)
FD48-1001-04-04	Socket/Female	1/4	1/4	1/4-18	Female NPT	2	51.1	(2.01)	26.9	(1.06)	20.6	(.81)

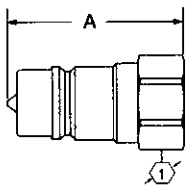

Figure 1

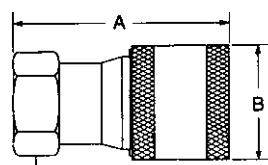
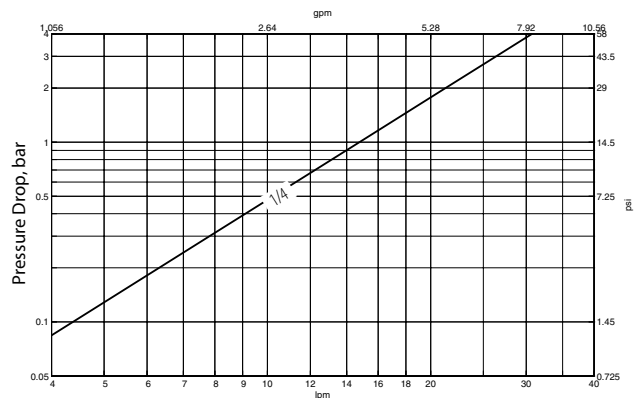

Figure 2

Flow Data

Pressure Drop Versus Flow Graph



Gallons Per Minute Flow
Test Fluid: MIL-H-5606 Oil at 100°F

Dust Cap/Plug

Part Number Buna-N	Body Size
FD48-1042-04*	1/4



Dust Cap/Plug

*Fits both plug/male and socket/female halves

ST Series

Fluid transfer & Hydraulic application

Danfoss Hansen ST Series is a straight-through coupling that is designed for use where minimum pressure drop is required and valving is not needed. These couplings are suited for various and versatile fluid transfer type systems.



Product Features

- Ball-latching mechanism
- Smooth bore permits free flow of liquid or gas
- Available in NPTF, BSPP and Hose stem end connections
- Standard seal material: Nitrile (NBR)
- Standard body material: Brass, 303 stainless steel, steel

European Pressure Equipment Directive

Couplings with nominal diameters up to and including 25 mm are designed and manufactured under Article 4.3 of the European Pressure Equipment Directive PED 2014/68/EU. Couplings with nominal diameters greater than 25 mm are designed and manufactured in accordance with the stipulations of Module A of the European Pressure Equipment Directive PED 2014/68/EU. They should not be used to convey unstable gases.

Physical Characteristics

Series	Body Size (in)	Max. Operating Pressure Brass Socket & Plug**		Max. Operating Pressure Brass Socket & Steel Plug**		Max. Operating Pressure Stainless Socket & Plug**		Max. Operating pressure for Hazardous liquids and gases Group 1		Min. Burst Pressure*		Rated Flow	
		(bar)	(psi)	(bar)	(psi)	(bar)	(psi)	(bar)	(psi)	(bar)	(psi)	(lpm)	(gpm)
1ST	1/8	193	2,800	234	3,400	290	4,200	***	***	772	11,200	10	2.7
2ST	1/4	359	5,200	379	5,500	517	7,500	***	***	1,436	20,800	21	5.6
3ST	3/8	193	2,800	290	4,200	434	6,300	***	***	772	11,200	57	15
4ST	1/2	152	2,200	241	3,500	248	3,600	***	***	608	8,800	83	22
6ST	3/4	117	1,700	145	2,100	207	3,000	***	***	468	6,800	250	66
8ST	1	90	1,300	138	2,000	138	2,000	***	***	360	5,200	530	140
10ST	1 1/4	117	1,700	186	2,700	152	2,200	***	***	468	6,800	697	184
12ST	1 1/2	97	1,400	152	2,200	172	2,500	33	480	388	5,600	1,124	297
16ST	2	97	1,400	152	2,200	103	1,500	27	390	388	5,600	1,855	490
20ST	2 1/2	62	900	103	1,500	—	—	20	290	248	3,600	3,131	827

* For Brass socket and plug. Other materials have 4 to 1 safety factor

** Operating pressure for Non Hazardous liquids and gases from Group 2

*** Operating pressure is same as Non Hazardous liquids and gases from Group 2 for this size

Applications & Markets

- Fluid Transfer
- Chemical
- Food and Beverage
- Injection Molding
- Marine
- Medical
- Pressure Washing
- Steam Cleaning

Flow Data

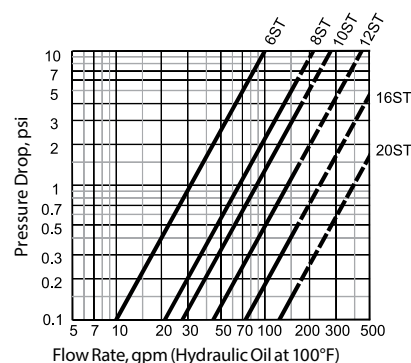
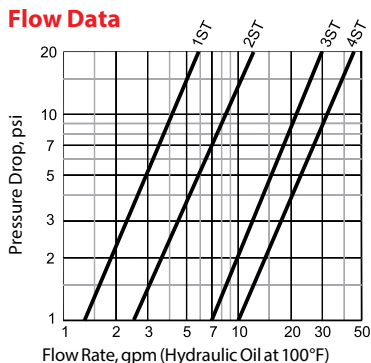

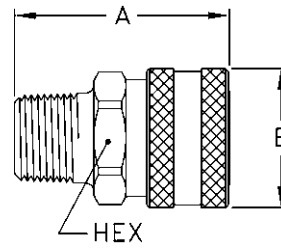

Figure 1

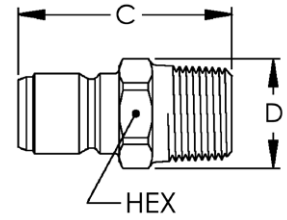

Figure 2

Male End Connections

Part Number	Brass	Steel	Stainless	Coupling Type	Body Size	Port Size	Thread	Type	Fig.	Dimensions						
										A	B	Hex	A	B	Hex	
											(in)	(in)	(in)	(mm)	(mm)	(mm)
1S10	—	—	LL1S10	Socket/Female	1/8	1/8	1/8-27	NPTF	1	1.06	0.72	0.56	26.9	18.3	14.2	
1S10BS	—	—	—	Socket/Female	1/8	1/8	1/8-28	BSPP	1	1.00	0.72	0.56	25.4	18.3	14.2	
2S15	—	—	LL2S15	Socket/Female	1/4	1/4	1/4-18	NPTF	1	1.72	0.97	0.81	43.7	24.6	20.6	
3S20	—	—	LL3S20	Socket/Female	3/8	3/8	3/8-18	NPTF	1	1.75	1.16	1.00	44.5	29.5	25.4	
3S20BS	—	—	LL3S20BS	Socket/Female	3/8	3/8	3/8-19	BSPP	1	1.71	1.16	1.00	43.4	29.5	25.4	
4S25	—	—	LL4S25	Socket/Female	1/2	1/2	1/2-14	NPTF	1	2.03	1.34	1.13	51.6	34.0	28.7	
4S25BS	—	—	LL4S25BS	Socket/Female	1/2	1/2	1/2-14	BSPP	1	1.80	1.34	1.13	45.7	34.0	28.7	
6S30	—	—	LL6S30	Socket/Female	3/4	3/4	3/4-14	NPTF	1	2.22	1.72	1.44	56.4	43.7	36.6	
6S30BS	—	—	—	Socket/Female	3/4	3/4	3/4-14	BSPP	1	2.03	1.72	1.44	51.6	43.7	36.6	
8S35	—	—	—	Socket/Female	1	1	1-11 1/2	NPTF	1	2.53	2.03	1.75	64.3	51.6	44.5	
8S35BS	—	—	—	Socket/Female	1	1	1-11	BSPP	1	2.37	2.03	1.75	60.2	51.6	44.5	

Part Number	Brass	Steel	Stainless	Coupling Type	Body Size	Port Size	Thread	Type	Fig.	Dimensions						
										C	D	Hex	C	D	Hex	
											(in)	(in)	(in)	(mm)	(mm)	(mm)
B1T10	—	1T10E	LL1T10	Plug/Male	1/8	1/8	1/8-27	NPTF	2	1.06	0.51	0.44	26.9	13.0	11.2	
B1T15	—	1T15	—	Plug/Male	8	1/4	1/4-18	NPTF	2	1.22	0.65	0.56	31.0	16.5	14.2	
B2T15	—	2T15	LL2T15	Plug/Male	1/4	1/4	1/4-18	NPTF	2	1.56	0.65	0.56	39.6	16.5	14.2	
—	—	—	HL2T15**	Plug/Male	1/4	1/4	1/4-18	NPTF	2	1.56	0.65	0.56	39.6	16.5	14.2	
B2T15BS	—	—	LL2T15BS	Plug/Male	1/4	1/4	1/4-19	BSPP	2	1.46	0.87	0.75	37.1	22.1	19.1	
B3T20	—	3T20	LL3T20	Plug/Male	3/8	3/8	3/8-18	NPTF	2	1.69	0.79	0.69	42.9	20.1	17.5	
—	—	—	HL3T20**	Plug/Male	3/8	3/8	3/8-18	NPTF	2	1.69	0.79	0.69	42.9	20.1	17.5	
B3T20BS	—	—	LL3T20BS	Plug/Male	3/8	3/8	3/8-19	BSPP	2	1.50	1.01	0.88	38.1	25.7	22.4	
B4T25	—	4T25	LL4T25	Plug/Male	1/2	1/2	1/2-14	NPTF	2	2.01	1.01	0.88	51.1	25.7	22.4	
B4T25BS	—	—	LL4T25BS	Plug/Male	1/2	1/2	1/2-14	BSPP	2	1.82	1.15	1.00	46.2	29.2	25.4	
B6T30	—	6T30	LL6T30	Plug/Male	3/4	3/4	3/4-14	NPTF	2	2.2	1.23	1.06	55.9	31.2	26.9	
B6T30BS	—	—	LL6T30BS	Plug/Male	3/4	3/4	3/4-14	BSPP	2	2.08	1.44	1.25	52.8	36.6	31.8	
B8T35	—	8T35	LL8T35	Plug/Male	1	1	1-11 1/2	NPTF	2	2.49	1.59	1.38	63.2	40.4	35.1	
B8T35BS	—	—	—	Plug/Male	1	1	1-11	BSPP	2	2.36	2.02	1.75	59.9	51.3	44.5	
B10T40	—	10T40	LL10T40	Plug/Male	1 1/4	1 1/4	1 1/4-11 1/2	NPTF	2	2.72	2.02	1.75	69.1	51.3	44.5	
B10T40BS	—	—	—	Plug/Male	1 1/4	1 1/4	1 1/4-11	BSPP	2	2.55	2.31	2.00	64.8	58.7	50.8	
B12T45	—	12T45	—	Plug/Male	1 1/2	1 1/2	1 1/2-11 1/2	NPTF	2	3.31	2.6	2.25	84.1	66.0	57.2	
B12T45BS	—	—	—	Plug/Male	1 1/2	1 1/2	1 1/2-11	BSPP	2	3.06	2.6	2.25	77.7	66.0	57.2	
B16T50	—	16T50	LL16T50	Plug/Male	2	2	2-11 1/2	NPTF	2	3.5	3.18	2.75	88.9	80.8	69.9	
B20T55	—	—	—	Plug/Male	2 1/2	2 1/2	2 1/2-8	NPTF	2	4.24	3.75	3.25	107.7	95.3	82.6	

**High impulse heat treated 416 stainless steel

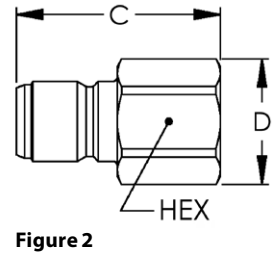
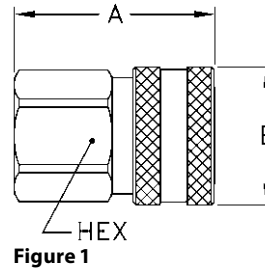

Female End Connections

Part Number	Brass	Steel	Stainless	Coupling Type	Body Size	Port Size	Thread	Type	Fig.	Dimensions						
										A	B	Hex	A	B	Hex	
											(in)	(in)	(in)	(mm)	(mm)	(mm)
1S11	—	—	LL1S11	Socket/Female	1/8	1/8	1/8-27	NPTF	1	1.06	0.72	0.56	26.9	18.3	14.2	
1S11BS	—	—	LL1S11BS	Socket/Female	1/8	1/8	1/8-28	BSPP	1	1.03	0.72	0.56	26.2	18.3	14.2	
2S16	—	—	LL2S16	Socket/Female	1/4	1/4	1/4-18	NPTF	1	1.5	0.97	0.81	38.1	24.6	20.6	
2S16BS	—	—	LL2S16BS	Socket/Female	1/4	1/4	1/4-19	BSPP	1	1.5	0.97	0.81	38.1	24.6	20.6	
3S21	—	—	LL3S21	Socket/Female	3/8	3/8	3/8-18	NPTF	1	1.59	1.16	1.00	40.4	29.5	25.4	
3S21BS	—	—	LL3S21BS	Socket/Female	3/8	3/8	3/8-19	BSPP	1	1.59	1.16	1.00	40.4	29.5	25.4	
4S26	—	—	LL4S26	Socket/Female	1/2	1/2	1/2-14	NPTF	1	1.91	1.34	1.13	48.5	34.0	28.7	
4S26BS	—	—	LL4S26BS	Socket/Female	1/2	1/2	1/2-14	BSPP	1	1.91	1.34	1.13	48.5	34.0	28.7	
6S31	—	—	LL6S31	Socket/Female	3/4	3/4	3/4-14	NPTF	1	2.06	1.72	1.44	52.3	43.7	36.6	
6S31BS	—	—	LL6S31BS	Socket/Female	3/4	3/4	3/4-14	BSPP	1	2.06	1.72	1.44	52.3	43.7	36.6	
8S36	—	—	LL8S36	Socket/Female	1	1	1-11 1/2	NPTF	1	2.33	2.03	1.75	59.2	51.6	44.5	
8S36BS	—	—	LL8S36BS	Socket/Female	1	1	1-11	BSPP	1	2.33	2.03	1.75	59.2	51.6	44.5	
10S41*	—	—	LL10S41	Socket/Female	1 1/4	1 1/4	1 1/4-11 1/2	NPTF	1	2.44	2.5	2.00	62.0	63.5	50.8	
10S41BS*	—	—	—	Socket/Female	1 1/4	1 1/4	1 1/4-11	BSPP	1	2.51	2.5	2.00	63.8	63.5	50.8	
12S46*	—	—	LL12S46	Socket/Female	1 1/2	1 1/2	1 1/2-11 1/2	NPTF	1	2.88	3.13	2.60	73.2	79.5	66.0	
12S46BS*	—	—	LL12S46BS	Socket/Female	1 1/2	1 1/2	1 1/2-11	BSPP	1	2.88	3.13	2.63	73.2	79.5	66.8	
16S51*	—	—	LL16S51	Socket/Female	2	2	2-11 1/2	NPTF	1	3.09	3.75	3.00	78.5	95.3	76.2	
16S51BS*	—	—	LL16S51BS	Socket/Female	2	2	2-11	BSPP	1	3.3	3.75	3.00	83.8	95.3	76.2	
20S56*	—	—	—	Socket/Female	2 1/2	2 1/2	2 1/2-8	NPTF	1	3.44	4.5	3.50	87.4	114.3	88.9	

Part Number	Brass	Steel	Stainless	Coupling Type	Body Size	Port Size	Thread	Type	Fig.	Dimensions						
										C	D	Hex	C	D	Hex	
											(in)	(in)	(in)	(mm)	(mm)	(mm)
B1T11	—	1T11	LL1T11	Plug/Male	1/8	1/8	1/8-27	NPTF	2	0.97	0.58	0.50	24.6	14.7	12.7	
B1T11BS	—	—	LL1T11BS	Plug/Male	1/8	1/8	1/8-28	BSPP	2	0.97	0.65	0.56	24.6	16.5	14.2	
B2T16	—	2T16	LL2T16	Plug/Male	1/4	1/4	1/4-18	NPTF	2	1.45	0.79	0.69	36.8	20.1	17.5	
—	—	—	HL2T16**	Plug/Male	1/4	1/4	1/4-18	NPTF	2	1.45	0.79	0.69	36.8	20.1	17.5	
B2T16BS	—	—	LL2T16BS	Plug/Male	1/4	1/4	1/4-19	BSPP	2	1.45	0.87	0.75	36.8	22.1	19.1	
B3T21	—	3T21	LL3T21	Plug/Male	3/8	3/8	3/8-18	NPTF	2	1.63	0.94	0.81	41.4	23.9	20.6	
—	—	—	HL3T21**	Plug/Male	3/8	3/8	3/8-18	NPTF	2	1.63	0.94	0.81	41.4	23.9	20.6	
B3T21BS	—	—	LL3T21BS	Plug/Male	3/8	3/8	3/8-19	BSPP	2	1.63	1.01	0.88	41.4	25.7	22.4	
B4T26	—	4T26	LL4T26	Plug/Male	1/2	1/2	1/2-14	NPTF	2	1.92	1.15	1.00	48.8	29.2	25.4	
B4T26BS	—	—	LL4T26BS	Plug/Male	1/2	1/2	1/2-14	BSPP	2	1.92	1.23	1.06	48.8	31.2	26.9	
B6T31	—	6T31	LL6T31	Plug/Male	3/4	3/4	3/4-14	NPTF	2	2.01	1.37	1.19	51.1	34.8	30.2	
B6T31BS	—	—	LL6T31BS	Plug/Male	3/4	3/4	3/4-14	BSPP	2	2.01	1.51	1.31	51.1	38.4	33.3	
B8T36	—	8T36	LL8T36	Plug/Male	1	1	1-11 1/2	NPTF	2	2.21	1.8	1.56	56.1	45.7	39.6	
B8T36BS	—	—	LL8T36BS	Plug/Male	1	1	1-11	BSPP	2	2.23	1.8	1.56	56.6	45.7	39.6	
B10T41	—	10T41	LL10T41	Plug/Male	1 1/4	1 1/4	1 1/4-11 1/2	NPTF	2	2.34	2.31	2.00	59.4	58.7	50.8	
B10T41BS	—	—	LL10T41BS	Plug/Male	1 1/4	1 1/4	1 1/4-11	BSPP	2	2.53	2.31	2.00	64.3	58.7	50.8	
B12T46	—	12T46	LL12T46	Plug/Male	1 1/2	1 1/2	1 1/2-11 1/2	NPTF	2	2.88	2.6	2.25	73.2	66.0	57.2	
B12T46BS	—	—	LL12T46BS	Plug/Male	1 1/2	1 1/2	1 1/2-11	BSPP	2	2.88	2.6	2.25	73.2	66.0	57.2	
B16T51	—	16T51	—	Plug/Male	2	2	2-11 1/2	NPTF	2	3.03	3.18	2.75	77.0	80.8	69.9	
B16T51BS	—	—	—	Plug/Male	2	2	2-11	BSPP	2	3.25	3.18	2.75	82.6	80.8	69.9	
B20T56	—	20T56	—	Plug/Male	2 1/2	2 1/2	2 1/2-8	NPTF	2	3.37	3.75	3.25	85.6	95.3	82.6	

*With Steel Sleeve

**High impulse heat treated 416 stainless steel

ST Series

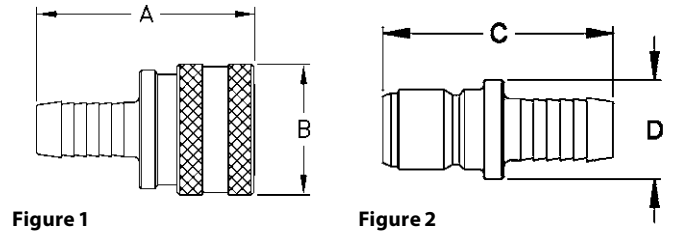

Hose Stem End Connections

Part Number	Brass	Stainless	Steel	Coupling Type	Body Size	Hose I.D.	Fig.	Dimensions			
								A	B	A	B
								(in)	(in)	(mm)	(mm)
1S12	LL1S12	—	—	Socket/Female	1/8	3/16	1	1.41	0.72	35.8	18.3
1S17	LL1S17	—	—	Socket/Female	1/8	1/4	1	1.41	0.72	35.8	18.3
2S17	LL2S17	—	—	Socket/Female	1/4	1/4	1	2.10	0.97	53.3	24.6
3S22	LL3S22	—	—	Socket/Female	3/8	3/8	1	2.09	1.16	53.1	29.5
4S27	LL4S27	—	—	Socket/Female	1/2	1/2	1	2.19	1.34	55.6	34.0
6S32	LL6S32	—	—	Socket/Female	3/4	3/4	1	3.19	1.72	81.0	43.7
8S37	LL8S37	—	—	Socket/Female	1	1	1	3.32	2.03	84.3	51.6

Part Number	Brass	Stainless	Steel	Coupling Type	Body Size	Hose I.D.	Fig.	Dimensions			
								C	D	C	D
								(in)	(in)	(mm)	(mm)
B1T12	LL1T12	—	—	Plug/Male	1/8	3/16	2	1.28	0.44	32.5	11.2
B1T17	LL1T17	—	—	Plug/Male	1/8	1/4	2	1.28	0.44	32.5	11.2
B2T17	LL2T17	—	—	Plug/Male	1/4	1/4	2	1.93	0.56	49.0	14.2
B3T22	LL3T22	—	—	Plug/Male	3/8	3/8	2	2.09	0.69	53.1	17.5
B4T27	LL4T27	—	—	Plug/Male	1/2	1/2	2	2.17	0.88	55.1	22.4
B6T32	LL6T32	—	—	Plug/Male	3/4	3/4	2	3.17	1.19	80.5	30.2
B8T37	—	—	8T37	Plug/Male	1	1	2	3.28	1.5	83.3	38.1

Dust Caps and Dust Plugs

Series	Dust Cap	Dust Plug
2ST	—	XPSDC1HK
3ST	—	XPSDC2HK
6ST	XPPDC4HK	XPSDC4HK
8ST	XPPDC6HK	—
10ST	XPPDC8HK	—



L7000 Series (Steel)

Full Flow

Fluid transfer & Hydraulic application



Danfoss Hansen L7000 Series steel quick disconnect coupling is a full-flow coupling with a rugged construction. Similar to the Danfoss H5000 Series, the heat treatment and hardened materials give the coupling excellent resistance to mechanical and hydraulic demands. It is suited for applications where maximum flow capacity is a requirement and valving is not needed.

Product Features

- Proprietary profile
- Full flow pull-to-connect couplings
- Ball-locking
- Excellent flow performance
- Standard body material: Zinc trivalent plated steel
- Optional dust caps and plugs (made of anodized aluminum)
- Standard seal material: NBR, FKM, EPDM

European Pressure Equipment Directive*

Couplings with nominal diameters up to and including 25 mm are designed and manufactured under Article 4.3 of the European Pressure Equipment Directive PED 2014/68/EU. Couplings with nominal diameters greater than 25 mm are designed and manufactured in accordance with the stipulations of Module A of the European Pressure Equipment Directive PED 2014/68/EU. They should not be used to convey unstable gases.

*Group 1 = Hazardous media / Group 2 = Other media

Applications & Markets

- Fluid Transfer Lines
- Refrigerant Circuits
- Applications where maximum flow capacity is required

Physical Characteristics

Body Size	Nominal Flow Diameter	Max. Operating Pressure (connected)*			
		Non hazardous liquids & gases in Group 2		Hazardous liquids & gases in Group 1	
(in)	(mm)	bar	(psi)	bar	(psi)
1/8	8	1,000	14,500	1,000	14,500
1/4	10	700	10,150	700	10,150
3/8	12	600	8,700	600	8,700
1/2	15	500	7,250	500	7,250
3/4	20	400	5,800	400	5,800
1	25	300	4,350	300	4,350
1 1/4	33	200	2,900	30	435
1 1/2	40	150	2,175	24	345
2	50	100	1,450	19	275

Flow Data

The nominal flow diameter of the coupling has no impact on pressure drop, as it is wider than the circuit diameter.

Seal Elastomer Data*

Seal Elastomer	Max. Operation Temperature Range
NBR (Nitrile)	-20°C +100°C / -4°F +212°F
FKM (Fluorocarbon)	-20°C +200°C / -4°F +392°F
EPDM (Ethylene-Propylene)**	-40°C +150°C / -40°F +302°F

*For reference only, based on Danfoss recommended temperatures.

**In accordance with NF L 17-241 or NAS 1613 rev. 5, depending on size.

Contact Danfoss technical support for further information on fluid compatibility.

L7000 Series (Steel)

Full Flow

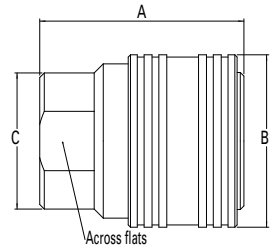

Figure 1

Sockets (Female)

Part Number			Body Size (in)	Nominal Flow Diameter (mm)	Thread Size** (Female) BSPP	Fig.	Dimensions								Weight	
NBR*	FKM	EPDM					A (in)	B (in)	C (in)	Across flats (in)	A (mm)	B (mm)	C (mm)	Across flats (mm)	lbs	grams
LA0700100	LA07001V0	LA07001E0	1/8	8	1/8-28	1	1.63	0.94	0.83	0.63	41.5	24	21	16	0.19	86
LA0701100	LA07011V0	LA07011E0	1/4	10	1/4-19	1	1.42	1.10	0.83	0.75	36	28	21	19	0.19	87
LA0702100	LA07021V0	LA07021E0	3/8	12	3/8-19	1	1.50	1.34	1.02	0.90	38	34	26	23	0.28	129
LA0703100	LA07031V0	LA07031E0	1/2	15	1/2-14	1	1.77	1.50	1.18	1.06	45	38	30	27	0.39	177
LA0704100	LA07041V0	LA07041E0	3/4	20	3/4-14	1	2.20	1.89	1.50	1.38	56	48	38	35	0.78	355
LA0705100	LA07051V0	LA07051E0	1	25	1-11	1	2.40	2.05	1.77	1.61	61	52	45	41	0.97	440
-	LA07061V0	LA07061E0	1 1/4	33	1 1/4-11	1	2.64	2.95	2.36	2.16	67	75	60	55	2.15	975
-	LA07071V0	LA07071E0	1 1/2	40	1 1/2-11	1	3.38	3.35	2.83	2.56	86	85	72	65	3.85	1745
-	LA07091V0	LA07091E0	2	50	2-11	1	3.46	3.82	3.27	2.95	88	97	83	75	4.11	1865

*Body sizes 1 1/4, 1 1/2 and 2 are supplied with FKM seals as a standard.

**Alternative end connections available upon request.

To obtain connected length of coupling add dimensions A (Fig. 1) and G (Fig. 2) together

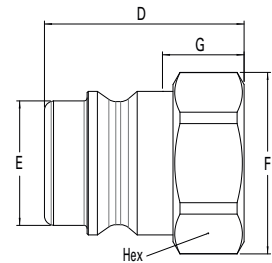

Figure 2

Plugs (Male)

Part Number	Body Size (in)	Nominal Flow Diameter (mm)	Thread Size* (Female) BSPP	Fig.	Dimensions										Weight	
					D (in)	E (in)	F (in)	G (in)	Hex (in)	D (mm)	E (mm)	F (mm)	G (mm)	Hex (mm)	lbs	grams
LA0700200	1/8	8	1/8-28	2	1.02	0.43	0.72	0.41	0.63	26	11	18.4	10.5	16	0.04	19
LA0701200	1/4	10	1/4-19	2	1.00	0.56	0.82	0.41	0.75	25.5	14.2	21	10.5	19	0.06	26
LA0702200	3/8	12	3/8-19	2	1.10	0.75	1.02	0.42	0.90	28	19	26	10.7	23	0.10	45
LA0703200	1/2	15	1/2-14	2	1.30	0.81	1.18	0.51	1.06	33	20.6	30	13	27	0.12	54
LA0704200	3/4	20	3/4-14	2	1.57	1.10	1.50	0.55	1.38	40	27.9	38	14	35	0.26	117
LA0705200	1	25	1-11	2	1.73	1.27	1.77	0.73	1.61	44	32.4	45	18.5	41	0.34	155
LA0706200	1 1/4	33	1 1/4-11	2	2.12	1.73	2.36	0.83	2.16	54	44	60	21	55	0.94	424
LA0707200	1 1/2	40	1 1/2-11	2	2.32	2.10	2.83	0.87	2.56	59	53.5	71.9	22	65	1.45	656
LA0709200	2	50	2-11	2	2.68	2.47	3.27	1.06	2.95	68	62.8	83	27	75	1.85	839

*Alternative end connections available upon request.

To obtain connected length of coupling add dimensions A (Fig. 1) and G (Fig. 2) together.

L7000 Series (Steel)

Full Flow

Dust Plugs and Dust Caps

Body Size	Socket Dust Plug Part Number	Plug Dust Cap Part Number
(in)	Anodized Aluminum	Anodized Aluminum
1/8	HD0510100	HD0510200
1/4	HD0511100	HD0511200
3/8	HD0512100	HD0512200
1/2	HD0513100	HD0513200
3/4	HD0514100	HD0514200
1	HD0515100	HD0515200
1 1/4	HD0516100	HD0516200
1 1/2	HD0517100	HD0517200
2	HD0519100	HD0519200



Seal Kit for Servicing Sockets (Female)

Body Size (in)	Seal & Back-up Ring Kit*					
	Buna-N seals & PTFE back-up rings	Qty	FKM seals & PTFE back-up rings	Qty	EPDM seals & PTFE back-up rings	Qty
1/8	HG 05001 00	50 O-rings + 50 Backup rings	HG 05001 V0	15 O-rings + 15 Backup rings	HG 05001 E0	15 O-rings + 15 Backup rings
1/4	HG 05011 00	50 O-rings + 50 Backup rings	HG 05011 V0	15 O-rings + 15 Backup rings	HG 05011 E0	15 O-rings + 15 Backup rings
3/8	HG 05021 00	50 O-rings + 50 Backup rings	HG 05021 V0	15 O-rings + 15 Backup rings	HG 05021 E0	15 O-rings + 15 Backup rings
1/2	HG 05031 00	50 O-rings + 50 Backup rings	HG 05031 V0	15 O-rings + 15 Backup rings	HG 05031 E0	15 O-rings + 15 Backup rings
3/4	HG 05041 00	50 O-rings + 50 Backup rings	HG 05041 V0	15 O-rings + 15 Backup rings	HG 05041 E0	15 O-rings + 15 Backup rings
1	HG 05051 00	50 O-rings + 50 Backup rings	HG 05051 V0	10 O-rings + 10 Backup rings	HG 05051 E0	10 O-rings + 10 Backup rings
1 1/4	LG 07061 00	15 O-rings + 15 Backup rings	HG 05061 V0	5 O-rings + 5 Backup rings	-	-
1 1/2	LG 07071 00	15 O-rings + 15 Backup rings	-	-	-	-
2	LG 07091 00	15 O-rings + 15 Backup rings	-	-	-	-

*The valve seal is not included in our repair kits

L7000 Series (Brass)

Full Flow

Fluid transfer & Hydraulic application



Danfoss' L7000 Series brass quick disconnect coupling is a full-flow coupling suited for applications where maximum flow capacity is required and valving is not needed. Mainly used in fluid transfer applications where stainless steel is not a requirement, it can vehicle a wide range of media and offers good corrosion resistance.

Product Features

- Proprietary profile
- Full flow pull-to-connect couplings
- Ball-locking
- Excellent flow performance
- Standard body material: Nickel-plated brass
- Standard seal material: NBR, FKM, EPDM
- Optional dust caps and plugs (made of anodized aluminum)

European Pressure Equipment Directive*

All couplings are designed and manufactured under Article 4.3 of the European Pressure Equipment Directive PED 2014/68/EU. Couplings with nominal diameters greater than 25 mm should not be used to convey gases in Group 1 (hazardous).

* Group 1 = Hazardous media / Group 2 = Other media

Applications & Markets

- Pressure Washing
- Steam-Cleaning Equipment
- Fluid Transfer Lines
- Refrigerant Circuits
- Applications where maximum flow capacity is required

Physical Characteristics

Body Size (in)	Nominal Flow Diameter (mm)	Max. Operating Pressure (connected)*			
		Liquids in Groups 1 and 2		Gases in Group 2	
		bar	(psi)	bar	(psi)
1/8	8	300	4,350	300	4,350
1/4	10	230	3,335	230	3,335
3/8	12	175	2,535	175	2,535
1/2	15	150	2,175	150	2,175
3/4	20	125	1,810	125	1,810
1	25	100	1,450	100	1,450
1 1/4	33	60	870	30	435
1 1/2	40	49	710	24	348
2	50	39	565	19	275

*Nominal diameters over 25 mm should not be used to convey gases in Group 1 (as per PED 2014/68/EU).

Flow Data

The nominal flow diameter of the coupling has no impact on pressure drop, as it is wider than the circuit diameter.

Seal Elastomer Data*

Seal Elastomer	Max. Operation Temperature Range
NBR (Nitrile)	-20°C +100°C / -4°F +212°F
FKM (Fluorocarbon)	-20°C +200°C / -4°F +392°F
EPDM (Ethylene-Propylene)**	-40°C +150°C / -40°F +302°F

*For reference only, based on Danfoss recommended temperatures.

**In accordance with NF L 17-241 or NAS 1613 rev. 5, depending on size.

Contact Danfoss technical support for further information on fluid compatibility.

L7000 Series (Brass)

Full Flow

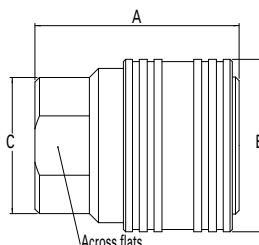

Figure 1

Sockets (Female)

Part Number			Body Size	Nominal Flow Diameter	Thread Size** (Female)	Dimensions										Weight	
Buna-N*	FKM	EPDM	(in)	(mm)	BSPP	Fig.	A (in)	B (in)	C (in)	Across flats (in)	A (mm)	B (mm)	C (mm)	Across flats (mm)	lbs	grams	
LL0700100	LL07001V0	LL07001E0	1/8	8	1/8-28	1	1.63	0.94	0.83	0.63	41.5	24	21	16	0.21	95	
LL0701100	LL07011V0	LL07011E0	1/4	10	1/4-19	1	1.42	1.10	0.83	0.75	36	28	21	19	0.21	96	
LL0702100	LL07021V0	LL07021E0	3/8	12	3/8-19	1	1.50	1.34	1.02	0.90	38	34	26	23	0.31	142	
LL0703100	LL07031V0	LL07031E0	1/2	15	1/2-14	1	1.77	1.50	1.18	1.06	45	38	30	27	0.43	195	
LL0704100	LL07041V0	LL07041E0	3/4	20	3/4-14	1	2.20	1.89	1.50	1.38	56	48	38	35	0.86	391	
LL0705100	LL07051V0	LL07051E0	1	25	1-11	1	2.40	2.05	1.77	1.61	61	52	45	41	1.07	484	
-	LL07061V0	LL07061E0	1 1/4	33	1 1/4-11	1	2.64	2.95	2.36	2.16	67	75	60	55	2.37	1073	
-	LL07071V0	LL07071E0	1 1/2	40	1 1/2-11	1	3.38	3.35	2.83	2.56	86	85	72	65	4.23	1920	
-	LL07091V0	LL07091E0	2	50	2-11	1	3.46	3.82	3.27	2.95	88	97	83	75	4.52	2052	

* Body sizes 1 1/4, 1 1/2 and 2 are supplied with FKM seals as a standard.

** Alternative end connections available upon request.

To obtain connected length of coupling add dimensions A (Fig. 1) and G (Fig. 2) together

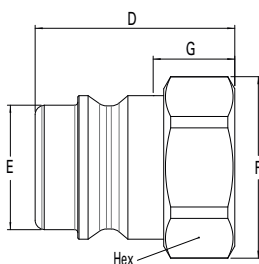

Figure 2

Plugs (Male)

Part Number	Body Size	Nominal Flow Diameter	Thread Size* (Female)	Dimensions												Weight	
	(in)	(mm)	BSPP	Fig.	D (in)	E (in)	F (in)	G (in)	Hex (in)	D (mm)	E (mm)	F (mm)	G (mm)	Hex (mm)	lbs	grams	
LL0700200	1/8	8	1/8-28	2	1.02	0.43	0.72	0.41	0.63	26	11	18.4	10.5	16	0.05	21	
LL0701200	1/4	10	1/4-19	2	1.00	0.56	0.82	0.41	0.75	25.5	14.2	21	10.5	19	0.06	29	
LL0702200	3/8	12	3/8-19	2	1.10	0.75	1.02	0.42	0.90	28	19	26	10.7	23	0.11	50	
LL0703200	1/2	15	1/2-14	2	1.30	0.81	1.18	0.51	1.06	33	20.6	30	13	27	0.13	59	
LL0704200	3/4	20	3/4-14	2	1.57	1.10	1.50	0.55	1.38	40	27.9	38	14	35	0.28	129	
LL0705200	1	25	1-11	2	1.73	1.27	1.77	0.73	1.61	44	32.4	45	18.5	41	0.38	171	
LL0706200	1 1/4	33	1 1/4-11	2	2.12	1.73	2.36	0.83	2.16	54	44	60	21	55	1.03	466	
LL0707200	1 1/2	40	1 1/2-11	2	2.32	2.10	2.83	0.87	2.56	59	53.5	71.9	22	65	1.59	722	
LL0709200	2	50	2-11	2	2.68	2.47	3.27	1.06	2.95	68	62.8	83	27	75	2.04	923	

*Alternative end connections available upon request.

To obtain connected length of coupling add dimensions A (Fig. 1) and G (Fig. 2) together.

L7000 Series (Brass)

Full Flow

Dust Plugs and Dust Caps

Body Size	Socket Dust Plug Part Number	Plug Dust Cap Part Number
(in)	Anodized Aluminum	Anodized Aluminum
1/8	HD0510100	HD0510200
1/4	HD0511100	HD0511200
3/8	HD0512100	HD0512200
1/2	HD0513100	HD0513200
3/4	HD0514100	HD0514200
1	HD0515100	HD0515200
1 1/4	HD0516100	HD0516200
1 1/2	HD0517100	HD0517200
2	HD0519100	HD0519200



Seal Kit for Servicing Sockets (Female)

Body Size	Seal & Back-up Ring Kit*					
	NBR seals & PTFE back-up rings	Qty	FKM seals & PTFE back-up rings	Qty	EPDM seals & PTFE back-up rings	Qty
1/8	HG 05001 00	50 O-rings + 50 Backup rings	HG 05001 V0	15 O-rings + 15 Backup rings	HG 05001 E0	15 O-rings + 15 Backup rings
1/4	HG 05011 00	50 O-rings + 50 Backup rings	HG 05011 V0	15 O-rings + 15 Backup rings	HG 05011 E0	15 O-rings + 15 Backup rings
3/8	HG 05021 00	50 O-rings + 50 Backup rings	HG 05021 V0	15 O-rings + 15 Backup rings	HG 05021 E0	15 O-rings + 15 Backup rings
1/2	HG 05031 00	50 O-rings + 50 Backup rings	HG 05031 V0	15 O-rings + 15 Backup rings	HG 05031 E0	15 O-rings + 15 Backup rings
3/4	HG 05041 00	50 O-rings + 50 Backup rings	HG 05041 V0	15 O-rings + 15 Backup rings	HG 05041 E0	15 O-rings + 15 Backup rings
1	HG 05051 00	50 O-rings + 50 Backup rings	HG 05051 V0	10 O-rings + 10 Backup rings	HG 05051 E0	10 O-rings + 10 Backup rings
1 1/4	LG 07061 00	15 O-rings + 15 Backup rings	HG 05061 V0	5 O-rings + 5 Backup rings	-	-
1 1/2	LG 07071 00	15 O-rings + 15 Backup rings	-	-	-	-
2	LG 07091 00	15 O-rings + 15 Backup rings	-	-	-	-

*The valve seal is not included in our repair kits

L7000 Series (Stainless Steel)

Full Flow

Fluid transfer & Hydraulic application



Product Features

- Proprietary profile
- Full flow pull-to-connect couplings
- Ball-locking
- Excellent flow performance
- Standard body material: AISI 316L Stainless steel
- Optional dust caps and plugs (made of anodized aluminum)
- Standard seal material: FKM, EPDM

Applications & Markets

- Pressure Washing
- Steam-cleaning Equipment
- Fluid Transfer Lines
- Refrigerant Circuits
- Applications where maximum flow capacity is required

Danfoss' L7000 Series stainless steel quick disconnect coupling is a full-flow coupling suited for applications where maximum flow capacity is required and valving is not needed. Mainly used in fluid transfer applications and offers excellent corrosion resistance.

European Pressure Equipment Directive*

Couplings with nominal diameters up to and including 25 mm are designed and manufactured under Article 4.3 of the European Pressure Equipment Directive PED 2014/68/EU. Couplings with nominal diameters greater than 25 mm are designed and manufactured in accordance with the stipulations of Module A of the European Pressure Equipment Directive PED 2014/68/EU. They should not be used to convey unstable gases.

*Group 1 = Hazardous media / Group 2 = Other media

Physical Characteristics

Body Size	Nominal Flow Diameter	Max. Operating Pressure (connected)			
		Non hazardous liquids & gases Group 2		Non hazardous liquids & gases Group 1	
(in)	(mm)	(bar)	(psi)	(bar)	(psi)
1/8	8	300	4,350	300	4,350
1/4	10	230	3,335	230	3,335
3/8	12	175	3,535	175	3,535
1/2	15	150	2,175	150	2,175
3/4	20	125	1,810	125	1,810
1	25	100	1,450	100	1,450
1 1/4	33	100	1,450	100	1,450
1 1/2	40	75	1,085	38	550
2	50	40	580	28	405

Flow Data

The nominal flow diameter of the coupling has no impact on pressure drop, as it is wider than the circuit diameter.

Seal Elastomer Data*	
Seal Elastomer	Max. Operation Temperature Range
FKM (Fluorocarbon)	-20°C +200°C / -4°F +392°F
EPDM (Ethylene-Propylene)**	-40°C +150°C / -40°F +302°F

*For reference only, based on Danfoss recommended temperatures.

**In accordance with NF L 17-241 or NAS 1613 rev. 5, depending on size.

Contact Danfoss technical support for further information on fluid compatibility.

L7000 Series (Stainless Steel)

Full Flow

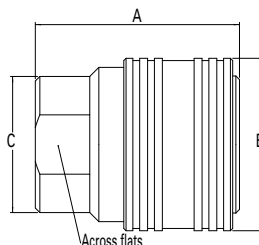

Figure 1

Sockets (Female)

Part Number		Body Size	Nominal Flow Diameter	Thread Size* (Female)	Fig.	Dimensions								Weight	
FKM	EPDM	(in)	(mm)	BSPP		A (in)	B (in)	C (in)	Across flats (in)	A (mm)	B (mm)	C (mm)	Across flats (mm)	lbs	grams
LZ07001V0	LZ07001E0	3/8	8	1/8-28	1	1.63	0.94	0.83	0.63	41.5	24	21	16	0.19	86
LZ07011V0	LZ07011E0	1/4	10	1/4-19	1	1.42	1.10	0.83	0.75	36	28	21	19	0.19	87
LZ07021V0	LZ07021E0	3/8	12	3/8-19	1	1.50	1.34	1.02	0.90	38	34	26	23	0.28	129
LZ07031V0	LZ07031E0	1/2	15	1/2-14	1	1.77	1.50	1.18	1.06	45	38	30	27	0.39	177
LZ07041V0	LZ07041E0	3/4	20	3/4-14	1	2.20	1.89	1.50	1.38	56	48	38	35	0.78	355
LZ07051V0	LZ07051E0	1	25	1-11	1	2.40	2.05	1.77	1.61	61	52	45	41	0.97	440
LZ07061V0	LZ07061E0	1 1/4	33	1 1/4-11	1	2.64	2.95	2.36	2.16	67	75	60	55	2.15	975
LZ07071V0	LZ07071E0	1 1/2	40	1 1/2-11	1	3.38	3.35	2.83	2.56	86	85	72	65	3.85	1745
LZ07091V0	LZ07091E0	2	50	2-11	1	3.46	3.82	3.27	2.95	88	97	83	75	4.11	1865

*Alternative end connections available upon request.

To obtain connected length of coupling add dimensions A (Fig. 1) and G (Fig. 2) together

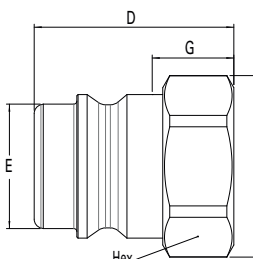

Figure 2

Plugs (Male)

Part Number		Body Size	Nominal Flow Diameter	Thread Size* (Female)	Fig.	Dimensions										Weight	
		(in)	(mm)	BSPP		D (in)	E (in)	F (in)	G (in)	Hex (in)	D (mm)	E (mm)	F (mm)	G (mm)	Hex (mm)	lbs	grams
LZ0700200		3/8	8	1/8-28	2	1.02	0.43	0.72	0.41	0.63	26	11.0	18.4	10.5	16	0.04	19
LZ0701200		1/4	10	1/4-19	2	1.00	0.56	0.82	0.41	0.75	25.5	14.2	21	10.5	19	0.06	26
LZ0702200		3/8	12	3/8-19	2	1.10	0.75	1.02	0.42	0.90	28	19.0	26	10.7	23	0.10	45
LZ0703200		1/2	15	1/2-14	2	1.30	0.81	1.18	0.51	1.06	33	20.6	30	13	27	0.12	54
LZ0704200		3/4	20	3/4-14	2	1.57	1.10	1.50	0.55	1.38	40	27.9	38	14	35	0.26	117
LZ0705200		1	25	1-11	2	1.73	1.27	1.77	0.73	1.61	44	32.4	45	18.5	41	0.34	155
LZ0706200		1 1/4	33	1 1/4-11	2	2.12	1.73	2.36	0.83	2.16	54	44.0	60	21	55	0.94	424
LZ0707200		1 1/2	40	1 1/2-11	2	2.32	2.10	2.83	0.87	2.56	59	53.5	71.9	22	65	1.45	656
LZ0709200		2	50	2-11	2	2.68	2.47	3.27	1.06	2.95	68	62.8	83	27	75	1.85	839

*Alternative end connections available upon request.

To obtain connected length of coupling add dimensions A (Fig. 1) and G (Fig. 2) together.

L7000 Series (Stainless Steel)

Full Flow

Dust Plugs and Dust Caps

Body Size (in)	Socket Dust Plug Part Number Anodized Aluminum	Plug Dust Cap Part Number Anodized Aluminum
1/8	HD0510100	HD0510200
1/4	HD0511100	HD0511200
3/8	HD0512100	HD0512200
1/2	HD0513100	HD0513200
3/4	HD0514100	HD0514200
1	HD0515100	HD0515200
1 1/4	HD0516100	HD0516200
1 1/2	HD0517100	HD0517200
2	HD0519100	HD0519200



Seal Kit for Servicing Sockets (Female)

Body Size (in)	Seal & Back-up Ring Kit*					
	NBR seals & PTFE back-up rings	Qty	FKM seals & PTFE back-up rings	Qty	EPDM seals & PTFE back-up rings	Qty
1/8	HG 05001 00	50 O-rings + 50 Backup rings	HG 05001 V0	15 O-rings + 15 Backup rings	HG 05001 E0	15 O-rings + 15 Backup rings
1/4	HG 05011 00	50 O-rings + 50 Backup rings	HG 05011 V0	15 O-rings + 15 Backup rings	HG 05011 E0	15 O-rings + 15 Backup rings
3/8	HG 05021 00	50 O-rings + 50 Backup rings	HG 05021 V0	15 O-rings + 15 Backup rings	HG 05021 E0	15 O-rings + 15 Backup rings
1/2	HG 05031 00	50 O-rings + 50 Backup rings	HG 05031 V0	15 O-rings + 15 Backup rings	HG 05031 E0	15 O-rings + 15 Backup rings
3/4	HG 05041 00	50 O-rings + 50 Backup rings	HG 05041 V0	15 O-rings + 15 Backup rings	HG 05041 E0	15 O-rings + 15 Backup rings
1	HG 05051 00	50 O-rings + 50 Backup rings	HG 05051 V0	10 O-rings + 10 Backup rings	HG 05051 E0	10 O-rings + 10 Backup rings
1 1/4	LG 07061 00	15 O-rings + 15 Backup rings	HG 05061 V0	5 O-rings + 5 Backup rings	-	-
1 1/2	LG 07071 00	15 O-rings + 15 Backup rings	-	-	-	-
2	LG 07091 00	15 O-rings + 15 Backup rings	-	-	-	-

*The valve seal is not included in our repair kits

FF Series (Steel)

ISO 16028 Interchange

Fluid transfer & Hydraulic application



Product Features

- Meets or exceeds the ISO 16028 standard
- Push-to-connect
- Standard sleeve lock prevents accidental disconnection
- Color identification rings available to help prevent crossing of lines
- Standard Material: High-resistant carbon steel with Dura-Kote plating, a whole new level of corrosion resistance with minimum 720 hours RR protection
- Dura-Kote plating:
 - Nickel-free
 - Solvent-free
 - Meets Global RoHS, ELV and REACH requirements
- Standard Seal Material: NBR+AU
- Available seal options: NBR+AU, FKM, EPDM, HNBR (upon request)

Physical Characteristics

ISO Size* (mm)	Coupling Size (in)	Maximum Operating Pressure				Minimum Burst Pressure				Fluid Rated Flow** (lpm)	Air Rated Flow** (gpm)	Loss ml-cc.	Inclusion ml-cc.	Force to Connect							
		Plug/ Male Half (bar)	Plug/ Male Half (psi)	Socket/ Female Half (bar)	Socket/ Female Half (psi)	Plug/ Male Half (bar)	Plug/ Male Half (psi)	Socket/ Female Half (bar)	Socket/ Female Half (psi)					N	Lbs						
6.3	¼	400	5,800	400	5,800	400	5,800	400	5,800	1,400	20,300	1,400	20,300	1,400	20,300	18	4.8	0.004	0.007	80	18.0
10.0	¾	400	5,800	400	5,800	400	5,800	400	5,800	1,400	20,300	1,400	20,300	1,400	20,300	40	10.6	0.006	0.010	140	31.5
12.5	½	400	5,800	400	5,800	400	5,800	400	5,800	1,400	20,300	1,400	20,300	1,400	20,300	77	20.3	0.012	0.013	195	43.8
16.0	¾	400	5,800	400	5,800	400	5,800	400	5,800	1,400	20,300	1,400	20,300	1,400	20,300	82	21.7	0.016	0.030	205	46.1
19.0	¾	400	5,800	400	5,800	400	5,800	1,300	18,850	1,300	18,850	1,400	20,300	1,400	20,300	114	30.1	0.034	0.015	215	48.3
25.0	1	400	5,800	400	5,800	400	5,800	1,260	18,270	1,260	18,270	1,260	18,270	1,260	18,270	184	48.6	0.032	0.033	260	58.5
-	1¼	300	4,350	300	4,350	300	4,350	900	13,050	900	13,050	900	13,050	900	13,050	260	68.7	0.170	0.053	200	45.0
-	1½	300	4,350	300	4,350	270	3,915	900	13,050	900	13,050	810	11,745	450	118.9	0.265	0.445	385	86.6		
-	2"	300	4,350	300	4,350	225	3,260	900	13,050	900	13,050	675	9,790	700	184.9	0.390	0.260	375	84.3		

* The ISO size corresponds to the internal diameter of the hose or the external diameter of the rigid tube (as defined in ISO 4397 Standard)
 ** Indicated values refer to a 1 bar/14.5 psi pressure drop
 *** 400 bar for static, steady or non-pulsed applications, 350 bar for ISO pressure rating for dynamic applications with moderate hydraulic shock

Applications & Markets

- Hydraulic and Fluid Transfer
- Construction Equipment
- Agricultural Equipment
- Utility Vehicles
- On-Highway Vehicles
- Stationary In-plant Hydraulics and Fluid Transfer
- Interchangeable with HTMA couplings in the 3/8" size

Flow Data

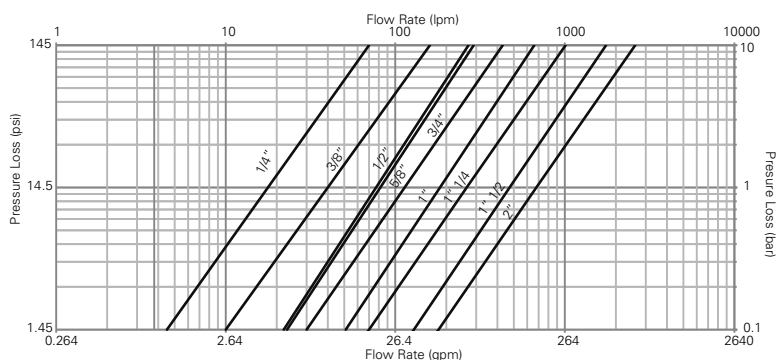

European Pressure Equipment Directive

All couplings are designed and manufactured under Article 4.3 of the European Pressure Equipment Directive PED 2014/68/EU. Couplings with nominal diameters greater than 25 mm should not be used to convey gases in Group 1 (hazardous).

Seal Elastomer Data*

Seal Elastomer	P/N Code	ISO Size (6FF, 10FF, 12FF, 16FF, 19FF and 25FF) Maximum Operation Temperature Range	Non-ISO Size (32FF, 50FF and 50FF) Maximum Operation Temperature Range
NBR (Nitrile) + AU (Polyurethane)		-25°C +100°C/-13°F +212°F	-20°C +100°C/-4°F +212°F
FKM	-143	-20°C +200°C/-4°F +392°F	-15°C +180°C/+5°F +356°F
EPDM (Ethylene-Propylene)	-192	-40°C +150°C/-40°F +302°F	on request
HNBR	-507	-32°C +150°C/-25°F +302°F	on request
Kalrez® 6375	-242	-20°C +275°C/-4°F +527°F	on request
Generic FFKM (Perfluorocarbon)	-503	-15°C +275°C/+5°F +527°F	on request

* For reference only, based on Danfoss recommended temperatures.
 Contact Danfoss technical support for further information on fluid compatibility

Maximum Operating Pressure

Coupling Size (in)	Nominal Flow Diameter	Non hazardous liquids Group 2				Non hazardous gases Group 2				Hazardous liquids Group 1			
		Plug & Connected		Socket		Plug & Connected		Socket		Plug & Connected		Socket	
		bar	(psi)	bar	(psi)	bar	(psi)	bar	(psi)	bar	(psi)	bar	(psi)
1 ½	30.1	300	4350	270	3915	300	4350	270	3915	66	955	66	955
2	39.2	300	4350	225	3260	25	360	25	360	50	725	50	725

* Nominal diameters over 25mm should not be used to convey gases in group 1 (PED 2014/68/EU)

FF Series (Steel)

ISO 16028 Interchange

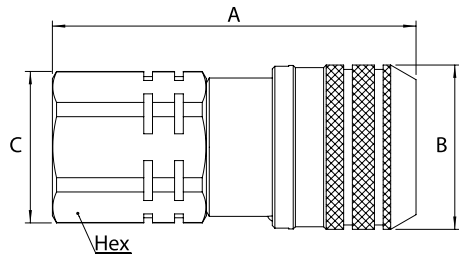

End-connection

ISO 6149-1
15° + metric thread

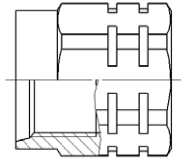

SAE J 1926-1
15° + UN/UNF thread

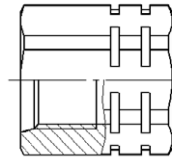

Danfoss S013A
15° + BSPP thread

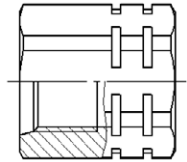

Figure 1

Sockets (Female)

Part Number	Body Size (in)	ISO Size (mm)	Nominal Flow Diameter (mm)	Thread Size* (Female)				Fig.	Dimensions				Weight						
				NPT	BSPP	ISO 6149-1	SAE J 1926-1		Danfoss S013A	A (in)	B (in)	C (in)	Hex (in)	A (mm)	B (mm)	C (mm)	Hex (mm)	lbs	grams
6FFS25	¼	6.3	6	¼ 18f	-	-	-	1	2.13	1.06	0.94	0.87	54	27	24	22	-	-	
6FFS25BS	¼	6.3	6	-	¼-19	-	-	1	2.13	1.06	0.94	0.87	54	27	24	22	-	-	
6FFS25FG	¼	6.3	6	-	-	-	G ¼	1	2.13	1.06	0.94	0.87	54	27	24	22	0.32	143	
6FFS56UN	¼	6.3	6	-	-	-	¾ 18FUNF	-	1	2.17	1.06	0.94	0.87	55	27	24	22	-	-
10FFS16FMET	¾	10	8.6	-	-	M16x1.5	-	1	2.67	1.26	1.16	1.06	67.8	32	29.5	27	-	-	
10FFS37	¾	10	8.6	¾ 18f	-	-	-	1	2.67	1.26	1.16	1.06	67.8	32	29.5	27	-	-	
10FFS37BS	¾	10	8.6	-	¾-19	-	-	1	2.67	1.26	1.16	1.06	67.8	32	29.5	27	-	-	
10FFS37FG	¾	10	8.6	-	-	-	G ¾	1	2.67	1.26	1.16	1.06	67.8	32	29.5	27	0.56	255	
10FFS50	¾	10	8.6	½ 14f	-	-	-	1	2.79	1.26	1.16	1.06	70.8	32	29.5	27	-	-	
10FFS50BS	¾	10	8.6	-	½-14	-	-	1	2.79	1.26	1.16	1.06	70.8	32	29.5	27	-	-	
10FFS50FG	¾	10	8.6	-	-	-	G ½	1	2.79	1.26	1.16	1.06	70.8	32	29.5	27	0.55	251	
10FFS56UN	¾	10	8.6	-	-	-	¾ 18FUNF	-	1	2.79	1.26	1.16	1.06	70.8	32	29.5	27	-	-
10FFS75UN	¾	10	8.6	-	-	-	¾ 16FUNF	-	1	2.79	1.26	1.16	1.06	70.8	32	29.5	27	-	-
10FFS87UN	¾	10	8.6	-	-	-	¾ 14FUNF	-	1	2.91	1.26	1.30	1.18	73.8	32	33	30	-	-
12FFS106UN	½	12.5	11	-	-	-	1 ½ 12FUN	-	1	3.50	1.50	1.56	1.42	89	38.2	39.5	36	-	-
12FFS50	½	12.5	11	½ 14f	-	-	-	1	3.27	1.50	1.56	1.42	83	38.2	39.5	36	-	-	
12FFS50BS	½	12.5	11	-	½-14	-	-	1	3.27	1.50	1.56	1.42	83	38.2	39.5	36	-	-	
12FFS50FG	½	12.5	11	-	-	-	G ½	1	3.27	1.50	1.56	1.42	83	38.2	39.5	36	1.1	498	
12FFS75	½	12.5	11	¾ 14f	-	-	-	1	3.39	1.50	1.56	1.42	86	38.2	39.5	36	-	-	
12FFS75BS	½	12.5	11	-	¾-14	-	-	1	3.39	1.50	1.56	1.42	86	38.2	39.5	36	-	-	
12FFS75FG	½	12.5	11	-	-	-	G ¾	1	3.39	1.50	1.56	1.42	86	38.2	39.5	36	1.08	488	
12FFS75UN	½	12.5	11	-	-	-	¾ 16FUNF	-	1	3.27	1.50	1.56	1.42	83	38.2	39.5	36	-	-
12FFS87UN	½	12.5	11	-	-	-	¾ 14FUNF	-	1	3.39	1.50	1.56	1.42	86	38.2	39.5	36	-	-
16FFS106UN	¾	16	13	-	-	-	1 ½ 12FUN	-	1	3.50	1.66	1.56	1.42	89	42.2	39.5	36	-	-
16FFS50	¾	16	13	½ 14f	-	-	-	1	3.27	1.66	1.56	1.42	83	42.2	39.5	36	-	-	
16FFS50BS	¾	16	13	-	½-14	-	-	1	3.27	1.66	1.56	1.42	83	42.2	39.5	36	-	-	
16FFS75	¾	16	13	¾ 14f	-	-	-	1	3.39	1.66	1.56	1.42	86	42.2	39.5	36	-	-	
16FFS75BS	¾	16	13	-	¾-14	-	-	1	3.39	1.66	1.56	1.42	86	42.2	39.5	36	-	-	
16FFS75FG	¾	16	13	-	-	-	G ¾	1	3.39	1.66	1.56	1.42	86	42.2	39.5	36	1.20	548	
16FFS75UN	¾	16	13	-	-	-	¾ 16FUNF	-	1	3.27	1.66	1.56	1.42	83	42.2	39.5	36	-	-
16FFS87UN	¾	16	13	-	-	-	¾ 14FUNF	-	1	3.39	1.66	1.56	1.42	86	42.2	39.5	36	-	-
19FFS100	¾	19	15	1 11,5f	-	-	-	1	3.80	1.82	1.81	1.65	96.6	46.2	46	42	-	-	
19FFS100BS	¾	19	15	-	1-11	-	-	1	3.80	1.82	1.81	1.65	96.6	46.2	46	42	-	-	
19FFS100FG	¾	19	15	-	-	-	G 1	1	3.80	1.82	1.81	1.65	96.6	46.2	46	42	1.62	737	
19FFS106UN	¾	19	15	-	-	-	1 ½ 12FUN	-	1	3.80	1.82	1.81	1.65	96.6	46.2	46	42	-	-
19FFS131UN	¾	19	15	-	-	-	1 ½ 12FUN	-	1	3.80	1.82	1.81	1.65	96.6	46.2	46	42	-	-
19FFS75	¾	19	15	¾ 14f	-	-	-	1	3.80	1.82	1.81	1.65	96.6	46.2	46	42	-	-	
19FFS75BS	¾	19	15	-	¾-14	-	-	1	3.80	1.82	1.81	1.65	96.6	46.2	46	42	-	-	
25FFS100	1	25	18	1 11,5f	-	-	-	1	4.07	2.17	2.36	2.17	103.5	55.2	60	55	-	-	
25FFS100BS	1	25	18	-	1-11	-	-	1	4.07	2.17	2.36	2.17	103.5	55.2	60	55	-	-	
25FFS125	1	25	18	1 ¼ 11,5f	-	-	-	1	4.07	2.17	2.36	2.17	103.5	55.2	60	55	-	-	
25FFS125BS	1	25	18	-	1 ¼-11	-	-	1	4.07	2.17	2.36	2.17	103.5	55.2	60	55	-	-	
25FFS125FG	1	25	18	-	-	-	G 1 ¼	1	4.07	2.17	2.36	2.17	103.5	55.2	60	55	2.74	1246	
25FFS131UN	1	25	18	-	-	-	1 ½ 12FUN	-	1	4.07	2.17	2.36	2.17	103.5	55.2	60	55	2.77	126
25FFS162UN	1	25	18	-	-	-	1 ½ 12FUN	-	1	4.07	2.17	2.36	2.17	103.5	55.2	60	55	-	-
32FFS125	1 ¼	-	22.1	1 ¾-11,5	-	-	-	1	4.93	2.55	2.36	2.17	125.2	64.8	60	55	4.22	1915	
32FFS125BS	1 ¼	-	22.1	-	1 ¾-11	-	-	1	4.93	2.55	2.36	2.17	125.2	64.8	60	55	4.18	1897	
32FFS162UN	1 ¼	-	22.1	-	-	-	1 ½ 12UN	-	1	4.93	2.55	2.36	2.17	125.2	64.8	60	55	4.16	1894
40FFS150	1 ½	-	30.1	1 ½-11,5	-	-	-	1	5.01	3.13	2.76	2.56	127.4	79.5	70	65	6.16	2796	
40FFS150BS	1 ½	-	30.1	-	1 ½-11	-	-	1	5.01	3.13	2.76	2.56	127.4	79.5	70	65	6.13	2781	
40FFS150FG	1 ½	-	30.1	-	-	-	1 ½	1	5.01	3.13	2.76	2.56	127.4	79.5	70	65	6.12	2775	
40FFS187UN	1 ½	-	30.1	-	-	-	1 ½ 12UN	-	1	5.01	3.13	2.76	2.56	127.4	79.5	70	65	6.10	2767
50FFS200	2	-	39.2	2-11,5	-	-	-	1	6.17	3.84	3.46	3.15	156.8	97.5	87.8	80	10.87	4931	
50FFS200BS	2	-	39.2	-	2-11	-	-	1	6.17	3.84	3.46	3.15	156.8	97.5	87.8	80	10.82	4908	
50FFS250UN	2	-	39.2	-	-	-	2 ½ 12UN	-	1	6.17	3.84	3.46	3.15	156.8	97.5	87.8	80	10.64	4825

*Alternative end connections available upon request.

To obtain connected length of coupling, add dimensions A (Fig. 1 or Fig. 2) and G (Fig. 3 or 4) together.

FF Series (Steel)

ISO 16028 Interchange

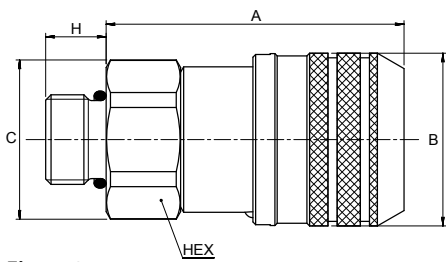
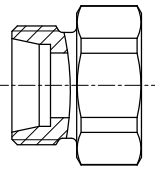

Figure 2

End-connection

ISO 8434-1
Metric thread



ISO 8434-1 + Bulkhead
Metric thread

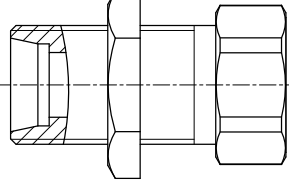

SAE J 1926-2
UN/UNF thread

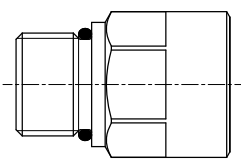

Sockets (Female)

Part Number	Body Size (in)	ISO Size (mm)	Nominal Flow Diameter (mm)	Thread Size*(Male)		Fig.	Dimensions								Weight			
				ISO 8434-1	SAE J 1926-2		A (in)	B (in)	C (in)	H (in.)	Hex (in)	A (mm)	B (mm)	C (mm)	H (mm)	Hex (mm)	lbs	grams
6FFS10LBH	¼	6.3	6	10L - M16x1,5 + bulkhead	-	2	1.65	1.06	0.94	1.38	0.87	42	27	24	35	22	-	-
6FFS8L	1/4	6,3	6	8L - M14x1,5	-	2	1,65	1,06	0,94	0,39	0,87	42	27	24	10	22	-	-
10FFS8L	¾	10	6	8L - M14x1,5	-	2	2,33	1,26	1,16	0,39	1,06	59,3	32	29,5	10	27	0,52	236
10FFS10L	¾	10	8	10L - M16x1,5	-	2	2,33	1,26	1,16	0,43	1,06	59,3	32	29,5	11	27	0,52	234
10FFS10LBH	¾	10	8	10L - M16x1,5	-	2	2,16	1,26	1,16	0,43	1,06	54,8	32	29,5	11	27	0,55	255
10FFS12L	¾	10	10	12L - M18x1,5	-	2	2,28	1,26	1,16	0,43	1,06	57,8	32	29,5	11	27	0,52	235
10FFS12LBH	¾	10	10	12L - M18x1,5	-	2	2,12	1,26	1,16	1,42	1,06	53,8	32	29,5	36	27	0,55	250
10FFS15L	¾	10	8,6	15L - M22x1,5	-	2	2,24	1,26	1,16	0,47	1,06	56,8	32	29,5	12	27	0,52	238
10FFS15LBH	¾	10	8,6	15L - M22x1,5	-	2	3,24	1,26	1,16	1,50	1,06	82,3	32	29,5	38	27	0,62	282
10FFS16S	¾	10	8,6	16S - M24x1,5 + bulkhead	-	2	2,26	1,26	1,16	0,55	1,06	57,3	32	29,5	14	27	0,46	211
10FFS56ORM	¾	10	8,6	-	¾ 18F UNF	2	2,61	1,26	1,06	0,47	0,94	66,4	32	27	12	23,8	-	-
10FFS75ORM	¾	10	8,6	-	¾ 16F UNF	2	2,61	1,26	1,06	0,55	0,94	66,4	32	27	14	23,8	-	-
12FFS15LBH	½	12	11	15L - M22x1,5 + bulkhead	-	2	3,66	1,50	1,56	1,50	1,42	93	38,2	39,5	38	36	1,05	478
12FFS16S	½	12	11	16S - M24x1,5	-	2	2,75	1,50	1,56	0,55	1,42	70	38,2	39,5	14	36	1,01	460
12FFS12L	½	12	11	12L - M18x1,5	-	2	2,84	1,50	1,56	0,43	1,42	72	38,2	39,5	11	36	0,92	420
12FFS15L	½	12	11	15L - M22x1,5	-	2	3,66	1,50	1,56	0,47	1,42	70	38,2	39,5	12	36	0,92	420
12FFS18LBH	½	12	11	18L - M26x1,5 + bulkhead	-	2	3,74	1,50	1,56	1,57	1,42	95	38,2	39,5	40	36	1,17	534
16FFS15LBH	¾	16	12	15L - M22x1,5 + bulkhead	-	2	2,68	1,66	1,56	1,50	1,42	68	42,2	39,5	38	36	-	-
16FFS16S	¾	16	12	16S - M24x1,5	-	2	2,75	1,66	1,56	0,55	1,42	70	42,2	39,5	14	36	1,11	505
16FFS18LBH	¾	16	13	18L - M26x1,5 + bulkhead	-	2	2,68	1,66	1,56	1,57	1,42	68	42,2	39,5	40	36	-	-

* Alternative end connections available upon request.

To obtain connected length of coupling, add dimensions A (Fig. 1 or Fig. 2) and G (Fig. 3 or 4) together.

Note that ISO 8434-1 will restrict usage of coupling to 250 bar for end connection 8L, 10L, 12L and 15L, and to 160 bar for end connection 18L.

FF Series (Steel)

ISO 16028 Interchange

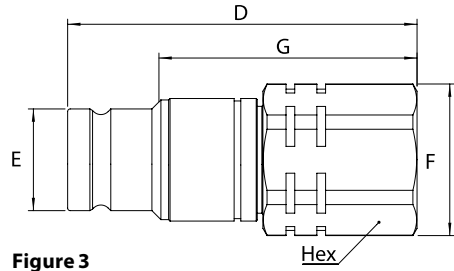
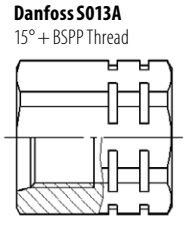
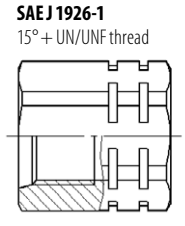
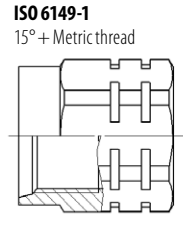

Figure 3

End-connection



Plugs (Male)

Part Number	Body Size (in)	ISO Size (mm)	Nominal Flow Diameter (mm)	Thread Size*(Female)				Dimensions												Weight		
				NPT	BSPP	ISO 6149-1	SAE J 1926-1	Danfoss S013A	Fig.	D (in)	E (in)	F (in)	G (in)	Hex (in)	D (mm)	E (mm)	F (mm)	G (mm)	Hex (mm)	lbs	grams	
6FFP25	¼	6.3	6	¼ 18f	-	-	-	-	-	3	2.01	0.64	0.94	1.58	0.87	51	16.2	24	40.1	22	-	-
6FFP25BS	¼	6.3	6	-	¼-19	-	-	-	-	3	2.01	0.64	0.94	1.58	0.87	51	16.2	24	40.1	22	-	-
6FFP25FG	¼	6.3	6	-	-	-	-	-	G ¼	3	2.01	0.64	0.94	1.58	0.87	51	16.2	24	40.1	22	0.20	90
6FFP56UN	¼	6.3	6	-	-	-	¾ 18f UNF	-	-	3	2.05	0.64	0.94	1.62	0.87	52	16.2	24	41.1	22	-	-
10FFP16FMET	¾	10	8.6	-	-	M16x1,5	-	-	-	3	2.56	0.78	1.16	1.96	1.06	65	19.7	29.5	49.7	27	-	-
10FFP37	¾	10	8.6	¾ 18f	-	-	-	-	-	3	2.56	0.78	1.16	1.96	1.06	65	19.7	29.5	49.7	27	-	-
10FFP37BS	¾	10	8.6	-	¾-19	-	-	-	-	3	2.56	0.78	1.16	1.96	1.06	65	19.7	29.5	49.7	27	-	-
10FFP37FG	¾	10	8.6	-	-	-	-	-	G ¾	3	2.56	0.78	1.16	1.96	1.06	65	19.7	29.5	49.7	27	0.35	157
10FFP50	¾	10	8.6	½ 14f	-	-	-	-	-	3	2.68	0.78	1.16	2.08	1.06	68	19.7	29.5	52.7	27	-	-
10FFP50BS	¾	10	8.6	-	½-14	-	-	-	-	3	2.68	0.78	1.16	2.08	1.06	68	19.7	29.5	52.7	27	-	-
10FFP50FG	¾	10	8.6	-	-	-	-	-	G ½	3	2.68	0.78	1.16	2.08	1.06	68	19.7	29.5	52.7	27	0.33	150
10FFP56UN	¾	10	8.6	-	-	-	¾ 18f UNF	-	-	3	2.68	0.78	1.16	2.08	1.06	68	19.7	29.5	52.7	27	-	-
10FFP75UN	¾	10	8.6	-	-	-	¾ 16f UNF	-	-	3	2.68	0.78	1.16	2.08	1.06	68	19.7	29.5	52.7	27	-	-
10FFP87UN	¾	10	8.6	-	-	-	¾ 14f UNF	-	-	3	2.80	0.78	1.30	2.19	1.18	71	19.7	33	55.7	30	-	-
12FFP106UN	½	12.5	11	-	-	-	1 ½ 12f UN	-	-	3	2.95	0.96	1.56	2.28	1.42	75	24.5	39.5	58	36	-	-
12FFP50	½	12.5	11	½ 14f	-	-	-	-	-	3	2.71	0.96	1.56	2.05	1.42	69	24.5	39.5	52	36	-	-
12FFP50BS	½	12.5	11	-	½-14	-	-	-	-	3	2.71	0.96	1.56	2.05	1.42	69	24.5	39.5	52	36	-	-
12FFP50FG	½	12.5	11	-	-	-	-	-	G ½	3	2.71	0.96	1.56	2.05	1.42	69	24.5	39.5	52	36	0.67	305
12FFP75	½	12.5	11	¾ 14f	-	-	-	-	-	3	2.83	0.96	1.56	2.16	1.42	72	24.5	39.5	55	36	-	-
12FFP75BS	½	12.5	11	-	¾-14	-	-	-	-	3	2.83	0.96	1.56	2.16	1.42	72	24.5	39.5	55	36	-	-
12FFP75FG	½	12.5	11	-	-	-	-	-	G ¾	3	2.83	0.96	1.56	2.16	1.42	72	24.5	39.5	55	36	0.65	295
12FFP75UN	½	12.5	11	-	-	-	¾ 16f UNF	-	-	3	2.71	0.96	1.56	2.05	1.42	69	24.5	39.5	52	36	-	-
12FFP87UN	½	12.5	11	-	-	-	¾ 14f UNF	-	-	3	2.83	0.96	1.56	2.16	1.42	72	24.5	39.5	55	36	-	-
16FFP106UN	¾	16	13	-	-	-	1 ½ 12f UN	-	-	3	2.95	1.06	1.56	2.28	1.42	75	27	39.5	58	36	-	-
16FFP50	¾	16	13	½ 14f	-	-	-	-	-	3	2.71	1.06	1.56	2.05	1.42	69	27	39.5	52	36	-	-
16FFP50BS	¾	16	13	-	½-14	-	-	-	-	3	2.71	1.06	1.56	2.05	1.42	69	27	39.5	52	36	-	-
16FFP75	¾	16	13	¾ 14f	-	-	-	-	-	3	2.83	1.06	1.56	2.16	1.42	72	27	39.5	55	36	-	-
16FFP75BS	¾	16	13	-	¾-14	-	-	-	-	3	2.83	1.06	1.56	2.16	1.42	72	27	39.5	55	36	-	-
16FFP75FG	¾	16	13	-	-	-	-	-	G ¾	3	2.83	1.06	1.56	2.16	1.42	72	27	39.5	55	36	0.7	317
16FFP75UN	¾	16	13	-	-	-	¾ 16f UNF	-	-	3	2.71	1.06	1.56	2.05	1.42	69	27	39.5	52	36	-	-
16FFP87UN	¾	16	13	-	-	-	¾ 14f UNF	-	-	3	2.83	1.06	1.56	2.16	1.42	72	27	39.5	55	36	-	-
19FFP100	¾	19	15	1 11,5f	-	-	-	-	-	3	3.69	1.18	1.81	2.84	1.65	93.8	29.9	46	72	42	-	-
19FFP100BS	¾	19	15	-	1-11	-	-	-	-	3	3.69	1.18	1.81	2.84	1.65	93.8	29.9	46	72	42	-	-
19FFP100FG	¾	19	15	-	-	-	-	-	G 1	3	3.69	1.18	1.81	2.84	1.65	93.8	29.9	46	72	42	1.14	518
19FFP106UN	¾	19	15	-	-	-	1 ½ 12f UN	-	-	3	3.69	1.18	1.81	2.84	1.65	93.8	29.9	46	72	42	-	-
19FFP131UN	¾	19	15	-	-	-	1 ¾ 12f UN	-	-	3	3.69	1.18	1.81	2.84	1.65	93.8	29.9	46	72	42	-	-
19FFP75	¾	19	15	¾ 14f	-	-	-	-	-	3	3.69	1.18	1.81	2.84	1.65	93.8	29.9	46	72	42	-	-
19FFP75BS	¾	19	15	-	¾-14	-	-	-	-	3	3.69	1.18	1.81	2.84	1.65	93.8	29.9	46	72	42	-	-
25FFP100	1	25	18	1 11,5f	-	-	-	-	-	3	4.12	1.42	2.36	3.22	2.17	104.6	36	60	81.7	55	-	-
25FFP100BS	1	25	18	-	1-11	-	-	-	-	3	4.12	1.42	2.36	3.22	2.17	104.6	36	60	81.7	55	-	-
25FFP125	1	25	18	1 ¼ 11,5f	-	-	-	-	-	3	4.12	1.42	2.36	3.22	2.17	104.6	36	60	81.7	55	-	-
25FFP125BS	1	25	18	-	1¼-11	-	-	-	-	3	4.12	1.42	2.36	3.22	2.17	104.6	36	60	81.7	55	-	-
25FFP125FG	1	25	18	-	-	-	-	-	G 1¼	3	4.12	1.42	2.36	3.22	2.17	104.6	36	60	81.7	55	2.08	948
25FFP131UN	1	25	18	-	-	-	1 ¾ 12f UN	-	-	3	4.12	1.42	2.36	3.22	2.17	104.6	36	60	81.7	55	2.09	952
25FFP162UN	1	25	18	-	-	-	1 ¾ 12f UN	-	-	3	4.12	1.42	2.36	3.22	2.17	104.6	36	60	81.7	55	-	-
32FFP125	1 ¼	-	22.1	1 ¾ 11,5	-	-	-	-	-	3	4.15	1.73	2.36	3.24	2.17	105.5	44	60	82.3	55	2.63	1193
32FFP125BS	1 ¼	-	22.1	-	1¾-11	-	-	-	-	3	4.15	1.73	2.36	3.24	2.17	105.5	44	60	82.3	55	2.60	1177
32FFP162UN	1 ¼	-	22.1	-	-	-	1 5/8 12 UN	-	-	3	4.15	1.73	2.36	3.24	2.17	105.5	44	60	82.3	55	2.59	1174
40FFP150	1 ½	-	30.1	1 ½ 11,5	-	-	-	-	-	3	4.13	2.24	2.61	3.01	2.36	105	57	66.3	76.5	60	3.15	1430
40FFP150BS	1 ½	-	30.1	-	1½-11	-	-	-	-	3	4.13	2.24	2.61	3.01	2.36	105	57	66.3	76.5	60	3.12	1417
40FFP150FG	1 ½	-	30.1	-	-	-	-	-	1 ½	3	4.13	2.24	2.61	3.01	2.36	105	57	66.3	76.5	60	3.11	1412
40FFP187UN	1 ½	-	30.1	-	-	-	1 ¾ 12 UN	-	-	3	4.13	2.24	2.61	3.01	2.36	105	57	66.3	76.5	60	3.10	1406
50FFP200	2	-	39.2	2 11,5	-	-	-	-	-	3	5.31	2.87	3.29	3.80	2.95	135	73	83.5	96.6	75	6.01	2725
50FFP200BS	2	-	39.2	-	2-11	-	-	-	-	3	5.31	2.87	3.29	3.80	2.95	135	73	83.5	96.6	75	5.97	2706
50FFP250UN	2	-	39.2	-	-	-	2 ½ 12 UN	-	-	3	5.31	2.87	3.29	3.80	2.95	135	73	83.5	96.6	75	5.78	2623

*Alternative end connections available upon request.
To obtain connected length of coupling, add dimensions A (Fig. 1 or Fig. 2) and G (Fig. 3 or 4) together.

FF Series (Steel)

ISO 16028 Interchange

End-connection

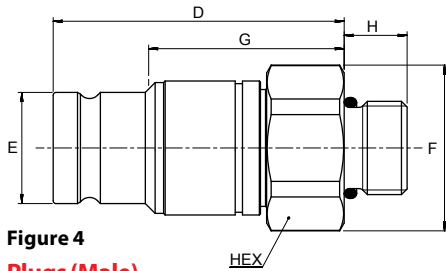
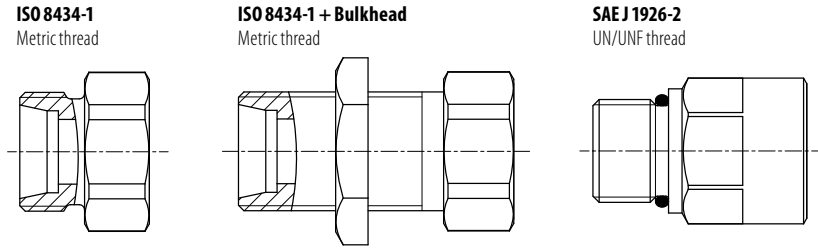

Figure 4
Plugs (Male)



Part Number	Body Size (in)	ISO Size (mm)	Nominal Flow Diameter (mm)	Thread Size*(Male)		Fig.	Dimensions								Weight					
				ISO 8434-1	SAE J 1926-2		D (in)	E (in)	F (in)	G (in)	H (in)	Hex (in)	D (mm)	E (mm)	F (mm)	G (mm)	H (mm)	Hex (mm)	lbs	grams
6FFP8LBH	1/4	6.3	6	8L-M14x1,5		4	1,54	0,64	0,64	1,11	1,33	0,87	39	16,2	24	28,1	34	22	0,22	103
6FFP10L	1/4	6.3	6	10L-M16x1,5		4	1,54	0,64	0,94	1,11	0,43	0,87	39	16,2	24	28,1	11	22	0,15	71,5
6FFP10LBH	1/4	6.3	6	M10L 16x1,5 + bulkhead		4	1,54	0,64	0,94	1,11	1,38	0,87	39	16,2	24	28,1	35	22	0,27	123
10FFP8L	3/8	10	6	8L-M14x1,5		4	2,20	0,78	1,16	1,84	0,39	1,06	56	19,7	29,5	46,7	10	27	0,3	137
10FFP10L	3/8	10	8	10L-M16x1,5		4	2,17	0,78	1,16	1,84	0,43	1,06	55	19,7	29,5	46,7	11	27	0,3	135
10FFP10LBH	3/8	10	8	10L-M16x1,5		4	2,05	0,78	1,16	1,45	1,38	1,06	52	19,7	29,5	36,7	35	27	0,35	160
10FFP12L	3/8	10	10	12L-M18x1,5		4	2,17	0,78	1,16	1,41	0,43	1,06	55	19,7	29,5	35,7	11	27	0,3	136
10FFP15L	3/8	10	8,6	5L-M22x1,5		4	2,13	0,78	1,16	1,84	0,47	1,06	54	19,7	29,5	46,7	12	27	0,31	139
10FFP15LBH	3/8	10	8,6	15L-M22x1,5 + bulkhead		4	2,01	0,78	1,16	2,9	1,50	1,06	51	19,7	29,5	73,7	38	27	0,4	183
10FFP12S	3/8	10	8,6	M20x1,5		4	2,01	0,78	1,16	1,41	0,50	1,06	51	19,7	29,5	35,7	15	27	0,26	122
10FFP12LBH	3/8	10	8,6	12L-M18x1,5		4	2,01	0,78	1,16	1,41	1,42	1,06	52	19,7	29,5	35,7	36	27	0,34	158
10FFP16S	3/8	10	8,6	16S-M24x1,5		4	2,52	0,78	1,16	1,92	0,55	1,06	64	19,7	29,5	48,7	14	27	0,27	123
10FFP56ORM	3/8	10	8,6	-	3/8 18UNF	4	2,5	0,78	1,06	1,9	0,47	0,94	63,6	19,7	27	48,3	12	23,8	0,33	150
10FFP75ORM	3/8	10	8,6	-	3/8 16UNF	4	2,	0,78	1,06	1,	0,55	0,94	63,6	19,7	27	48,3	14	23,8	0,34	156
12FFP12L	1/2	12	11	12L-M18x1,5		4	2,28	0,96	1,56	1,61	0,66	1,42	58	24,5	39,5	41	17	36	0,65	295
12FFP15L	1/2	12	11	15L-M22x1,5		4	2,12	0,96	1,56	3,07	0,47	1,42	54	24,5	39,5	78	12	36	0,51	234
12FFP15LBH	1/2	12	11	15L-M22x1,5 + bulkhead		4	2,12	0,96	1,56	2,95	1	1,42	54	24,5	39,5	75	38	36	0,65	297
12FFP16S	1/2	12	11	16S-M24x1,5		4	2,71	0,96	1,56	2,05	0,55	1,42	69	24,5	39,5	52	14	36	0,61	279
12FFP18LBH	1/2	12	11	18L-M26x1,5 + bulkhead		4	2,12	0,96	1,56	3,03	1,57	1,42	54	24,5	39,5	77	40	36	0,78	353
16FFP15LBH	3/4	16	12	15L-M22x1,5 + bulkhead		4	2,12	1,06	1,56	1,45	1,5	1,42	54	27	39,5	37	38	36	0,65	298
16FFP16S	3/4	16	12	16S-M24x1,5		4	2,71	1,06	1,56	2,05	0,55	1,42	69	27	39,5	52	14	36	0,62	280
16FFP18LBH	3/4	16	13	18L-M26x1,5 + bulkhead		4	2,12	1,06	1,56	1,45	1,57	1,42	54	27	39,5	37	40	36	0,78	353

*Alternative end connections available upon request.
To obtain connected length of coupling, add dimensions A (Fig. 1 or Fig. 2) and G (Fig. 3 or 4) together.
Note that ISO 8434-1 will restrict usage of coupling to 250 bar for end connection 8L, 10L, 12L and 15L, and to 160 bar for end connection 18L.

Socket (Female) Dust Plug

Body Size (in)	Body Size (in) with color ring	Part Number	Coupling Type	Dust Plug Material
1/4	3/8	SDC6FF	Socket/Female	PVC
3/8*	-	SDC10FF	Socket/Female	PVC
1/2	-	SDC12FF	Socket/Female	PVC
3/8	-	SDC16FF	Socket/Female	PVC
3/4	1/2	SDC19FF	Socket/Female	PVC
1	3/4	SDC25FF	Socket/Female	PVC

*Dust caps and dust plugs are offered in black.

Plug (Male) Dust Cap

Body Size (in)	Part Number	Coupling Type	Dust Plug Material
1/4	XPDC6FF	Plug/Male	PVC
3/8*	XPDC10FF	Plug/Male	PVC
1/2	XPDC12FF	Plug/Male	PVC
3/8	XPDC16FF	Plug/Male	PVC
3/4	XPDC19FF	Plug/Male	PVC
1	XPDC25FF	Plug/Male	PVC



Color Coding Ring Option*

Body Size (in)	ISO Size (mm)	Size	Socket/Female Ring Part Number**				Plug/Male Ring Part Number**				Tool Part Number	Tool & Rings Kit Part Number***
			Blue	Red	Yellow	Green	Blue	Red	Yellow	Green		
1/4	6	6FF	CR6FFSLB	CR6FFSRD	CR6FFSYL	CR6FFSDG	CR6FFPLB	CR6FFPRD	CR6FFPYL	CR6FFPDG	CR6FFSP93	CRKIT6FF
3/8	10	10FF	CR10FFSLB	CR10FFSRD	CR10FFSYL	CR10FFSDG	CR10FFPLB	CR10FFPRD	CR10FFPYL	CR10FFPDG	CR10FFSP93	CRKIT10FF
1/2	12,5	12FF	CR12FFSLB	CR12FFSRD	CR12FFSYL	CR12FFSDG	CR12FFPLB	CR12FFPRD	CR12FFPYL	CR12FFPDG	CR12FFSP93	CRKIT12FF
3/8	16	16FF	CR16FFSLB	CR16FFSRD	CR16FFSYL	CR16FFSDG	CR16FFPLB	CR16FFPRD	CR16FFPYL	CR16FFPDG	CR16FFSP93	CRKIT16FF
3/4	19	19FF	CR19FFSLB	CR19FFSRD	CR19FFSYL	CR19FFSDG	CR19FFPLB	CR19FFPRD	CR19FFPYL	CR19FFPDG	CR19FFSP93	CRKIT19FF

For color coded rings TPE material is used that offers excellent flexibility which allows a very good shock resistance in demanding applications.
Good thermal, chemical and weather resistance provides a great fit on the coupling and an extended life time in toughest conditions.
The color coded rings are easy to install by using the referenced tools. Please refer to the user guide on "Danfoss.com"

* For requests on alternative colors or installation instructions, please contact your Danfoss sales representative.

** Orders must be in multiples of 10 pcs.

*** The kit consists of a tool plus 10 socket rings and 10 plug rings of each color.



FFCUP Series

ISO 16028 Connect Under Pressure Flat Face Plug/Male

Fluid transfer & Hydraulic application



Danfoss Hansen FFCUP Series plug/male coupling is an ISO 16028 standard interchange. The flush face design prevents fluid loss on disconnection and air inclusion on connection guaranteeing excellent flow capability. An integrated patented system allows the FFCUP Series plug to be connected to a socket/female half coupling under 350 bar (5075 psi) residual pressure.

Product Features

- Designed and manufactured in accordance with Article 4.3 of the European Pressure Equipment Directive PED 2014/68/EU
- Meets dimensional requirements of ISO 16028
- Push to connect
- Connect under residual pressure
- Shock resistant color coding ring option available to prevent accidental crossing of lines
- Standard Material: High-resistant carbon steel with Dura-Kote™ plating, a whole new level of corrosion resistance with minimum 720 hours RR protection
- Dura-Kote™ plating: Nickel-free Solvent-free Meets Global RoHS, ELV and REACH requirements
- Alternative end connections available upon request
- Standard seal material: NBR (Nitrile) + AU (Polyurethane)
- Utilize FF Series dust caps

Physical Characteristics

Body Size	ISO Size*	Nominal Flow Diameter	Max. Operating Pressure	Min. Burst Pressure	Rated Flow**	Air Inclusion	Fluid Loss	Force to Connect				
(in)	(mm)	(mm)	(bar)	(psi)	(lpm)	(gpm)	ml-cc.	ml-cc.	N	lbf		
3/8	10	8.6	350	5,075	1,400	20,300	29.4	7.76	0.010	0.006	350	79
1/2	12.5	11	350	5,075	1,400	20,300	46.8	12.36	0.013	0.012	270	60.7

* The ISO size corresponds to the internal diameter of the hose or the external diameter of the rigid tube (as defined in ISO 4397 Standard)

** Indicated values refer to a 1 bar/14.5 psi pressure drop

Connect Under Pressure Operating Guidelines

- The plug can be connected against 350 bar/5075 psi residual pressure to sockets/females meeting ISO 16028 standard requirements.
- Plug only is under pressure while connected
- During the connection phase, the socket must not be under pressure
- Disconnection under pressure is strictly forbidden
- Connection under pressure may require a few seconds: the force to connect must be maintained during this lapse of time

Applications & Markets

- Connection to Hydraulic pumps, jacks, distributors and accessories
- Hydraulic Circuits
- Material Handling
- Construction
- Agriculture
- Iron and Steel Industry
- Railway
- Industrial Plants

Flow Data

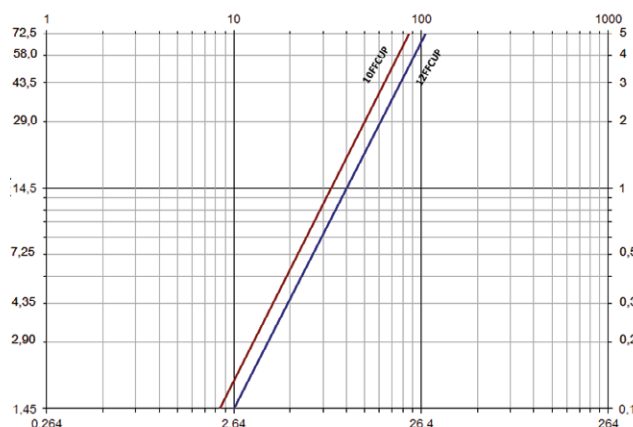

Seal Elastomer Data*

Seal Elastomer	Max. Operation Temperature Range
NBR (Nitrile) + AU (Polyurethane)	-25°C +100°C / -13°F +212°F

* For reference only, based on Danfoss recommended temperatures.

Contact Danfoss technical support for further information on fluid compatibility

FFCUP Series

ISO 16028 Connect Under Pressure Flat Face Plug/Male

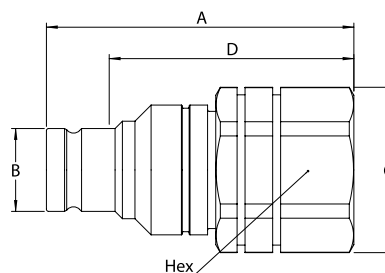

Figure 1

Plugs (Male)

Part Number	Body Size	ISO Size	Nominal Flow Diameter	Thread Size* (Female)			Fig.	Dimensions								Weight			
				NPT	BSPB	SAE J 1926-1		A (in)	B (in)	C (in)	D (in)	Hex (in)	A (mm)	B (mm)	C (mm)	D (mm)	Hex (mm)	lbs	grams
10FFPCUP37	3/8	10	8.6	3/8-18	-		1	2.89	0.74	1.55	2.28	1.41	73.5	18.7	39.5	58.0	36	0.69	314
10FFPCUP37BS				-	3/8-19		1	2.89	0.74	1.55	2.28	1.41	73.5	18.7	39.5	58.0	36	0.69	314
10FFPCUP50				1/2-14	-		1	2.89	0.74	1.55	2.28	1.41	73.5	18.7	39.5	58.0	36	0.66	300
10FFPCUP50BS				-	1/2-14		1	2.89	0.74	1.55	2.28	1.41	73.5	18.7	39.5	58.0	36	0.66	300
12FFPCUP50	1/2	12.5	11	1/2-14	-		1	3.03	0.96	1.55	2.36	1.41	77	24.52	39.5	60	36	0.77	350
12FFPCUP50BS				-	1/2-14		1	3.03	0.96	1.55	2.36	1.41	77	24.52	39.5	60	36	0.76	346
12FFPCUP56UN				9/16 18f UNF	-		1	2.87	0.96	1.55	2.2	1.41	73	24.52	39.5	56	36	0.74	336
12FFPCUP75UN				3/4 16f UNF	-		1	3.03	0.96	1.55	2.36	1.41	77	24.52	39.5	60	36	0.77	351

* Alternative end connections available upon request.

Color Coding Ring Option*

Body Size (in)	ISO Size (mm)	Nominal Flow Diameter (mm)	Plug/Male Ring Part Number**				Tool Part Number
			Blue	Red	Yellow	Green	
3/8	10	8.6	CR12FFPLB	CR12FFPRD	CR12FFPYL	CR12FFPDG	CR12FFSP93
1/2	12.5	11	CR16FFPLB	CR16FFPRD	CR16FFPYL	CR16FFPDG	CR16FFSP93

For color coded rings TPE material is used that offers excellent flexibility which allows a very good shock resistance in demanding applications.

Good thermal, chemical and weather resistance provides a great fit on the coupling and a extended life time in toughest conditions.

The color coded rings are easy to install by using the referenced tools.

* For requests on alternative colors or installation instructions, please contact your Danfoss sales representative.

** Orders must be in multiples of 10 pcs.

*** The kit consists of a tool plus 10 socket rings and 10 plug rings of each color.



MLFF Series (Stainless Steel)

ISO 16028 Flat Face/Dry Break

Fluid transfer & Hydraulic application



Danfoss Hansen MLFF Series stainless steel coupling is a flat face dry break coupling used for hydraulic applications. The MLFF Series interchanges with all ISO 16028 profiles. Due to its stainless steel design, it is corrosion resistant and can handle aggressive environments.

Product Features

- Designed and manufactured under Article 4.3 of the European Pressure Equipment Directive PED 2014/68/EU
- Safety sleeve lock prevents accidental disconnections
- Push to connect with double shut-off valving
- Shock resistant color coding ring option available in sizes 10FF, 12FF, 16FF and 19FF to prevent accidental crossing of lines
- Resistant to aggressive environments and corrosion
- Utilize FF Series dust caps
- Standard body material: 316L Stainless steel corrosion resistant
- Alternative end connections available upon request
- Standard seal material: FKM, EPDM, NBR+AU, HNBR (upon request)

Physical Characteristics

ISO Size* (mm)	Coupling Size (in)	Maximum Operating Pressure						Minimum Burst Pressure						Fluid Rated Flow** (lpm)	Air Rated Flow** (gpm)	Loss ml-cc.	Inclusion ml-cc.	Force to Connect	
		Connected		Plug/ Male Half		Socket/ Female Half		Plug/ Connected		Male Half		Female Half						N	Lbs
6.3	¼	250	3,625	250	3,625	250	3,625	2,335	33,858	1,640	23,780	1,330	19,285	17	4.49	0.004	0.007	80	18.0
10	¾	250	3,625	250	3,625	250	3,625	1,672	24,244	1,664	24,128	845	12,253	29	7.66	0.006	0.010	140	31.5
12	½	250	3,625	250	3,625	250	3,625	1,679	24,346	997	14,457	993	14,399	55	14.53	0.012	0.013	195	43.8
16	¾	250	3,625	250	3,625	250	3,625	1,190	17,255	950	13,775	880	12,760	67	17.70	0.016	0.030	205	46.1
19	¾	250	3,625	250	3,625	250	3,625	1,370	19,865	882	12,789	845	12,253	105	27.74	0.034	0.015	215	48.3
25	1	250	3,625	250	3,625	250	3,625	1,690	24,505	1,000	14,500	850	12,325	177	46.76	0.032	0.033	260	58.5
-	1½	250	3,625	250	3,625	250	3,625	750	10,875	750	10,875	750	10,875	450	118.9	0.265	0.445	385	86.6
-	2"	175	2,535	175	2,535	175	2,535	525	7,610	525	7,610	525	7,610	700	184.9	0.390	0.260	375	84.3

* The ISO size corresponds to the internal diameter of the hose or the external diameter of the rigid tube (as defined in ISO 4397 Standard)

** Indicated values refer to a 1 bar/14.5 psi pressure drop

Applications & Markets

- Construction
- Agriculture
- Iron and Steel Industry
- Railway
- Oil and Gas
- Marine
- Material Handling
- General Hydraulic Applications

European Pressure Equipment Directive

All couplings are designed and manufactured under Article 4.3 of the European Pressure Equipment Directive PED 2014/68/EU. Couplings with nominal diameters greater than 25 mm should not be used to convey gases in Group 1 (hazardous).

Flow Data

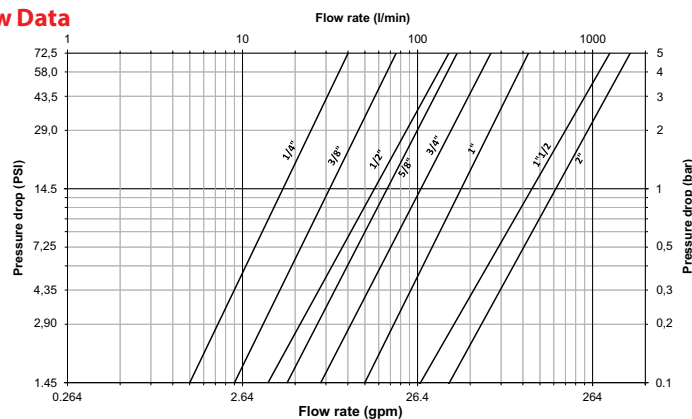

Seal Elastomer Data*

Seal Elastomer	P/N Code	ISO Size (6FF to 25FF) Maximum Operation Temperature Range	Non-ISO Size (40FF and 50FF) Maximum Operation Temperature Range
NBR (Nitrile) + AU (Polyurethane)	-	-25°C/+100°C/-13°F/+212°F	on request
FKM	-143	-20°C/+200°C/-4°F/+392°F	-20°C/+200°C/-4°F/+392°F
EPDM (Ethylene-Propylene)	-192	-40°C/+150°C/-40°F/+302°F	on request

*For reference only, based on Danfoss recommended temperatures.
Contact Danfoss technical support for further information on fluid compatibility.

Maximum Operating Pressure

Coupling Size (in)	Nominal Flow Diameter	Non hazardous liquids Group 2				Non hazardous gases Group 2				Hazardous liquids Group 1			
		Plug & Connected		Socket		Plug & Connected		Socket		Plug & Connected		Socket	
		bar	(psi)	bar	(psi)	bar	(psi)	bar	(psi)	bar	(psi)	bar	(psi)
1 ½	30.1	300	4350	270	3915	300	4350	270	3915	66	955	66	955
2	39.2	300	4350	225	3260	25	360	25	360	50	725	50	725

* Nominal diameters over 25mm should not be used to convey gases in group 1 (PED 2014/68/EU)

MLFF Series (Stainless Steel)

ISO 16028 Flat Face/Dry Break

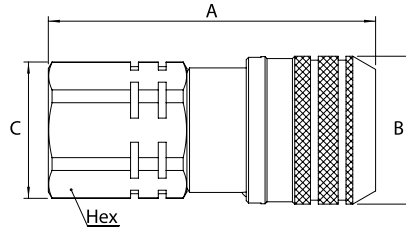

Figure 1

Sockets (Female)

Part Number		Body Size	ISO Size	Nominal Flow Diameter	Thread Size*(Female)		Dimensions				Weight							
NBR+AU	FKM	EPDM	(in)	(mm)	(mm)	NPT	BSPB	Fig.	A (in)	B (in)	C (in)	Hex (in)	A (mm)	B (mm)	C (mm)	Hex (mm)	lbs	grams
ML6FFS2S	ML6FFS2S143	ML6FFS2S192	¼	6.3	6	¼-18	-	1	2.13	1.06	0.94	0.87	54	27	24	22	0.30	135
ML6FFS2SBS	ML6FFS2SBS143	ML6FFS2SBS192	¼	6.3	6	-	¼-19	1	2.13	1.06	0.94	0.87	54	27	24	22	0.30	135
ML10FFS37	ML10FFS37143	ML10FFS37192	¾	10	8.6	¾-18	-	1	2.68	1.26	1.16	1.06	68	32	29.5	27	0.54	245
ML10FFS37BS	ML10FFS37BS143	ML10FFS37BS192	¾	10	8.6	-	¾-19	1	2.68	1.26	1.16	1.06	68	32	29.5	27	0.54	245
ML10FFS50BS	ML10FFS50BS143	ML10FFS50BS192	¾	10	8.6	-	½-14	1	2.80	1.26	1.16	1.06	71	32	29.5	27	0.53	240
ML12FFS50	ML12FFS50143	ML12FFS50192	½	12.5	11	½-14	-	1	3.27	1.50	1.56	1.42	83	38	39.5	36	1.03	470
ML12FFS50BS	ML12FFS50BS143	ML12FFS50BS192	½	12.5	11	-	½-14	1	3.27	1.50	1.56	1.42	83	38	39.5	36	1.03	470
ML12FFS75BS	ML12FFS75BS143	ML12FFS75BS192	½	12.5	11	-	¾-14	1	3.39	1.50	1.56	1.42	86	38	39.5	36	1.01	460
ML16FFS75	ML16FFS75143	ML16FFS75192	¾	16	13	¾-14	-	1	3.39	1.66	1.56	1.42	86	42	39.5	36	1.21	550
ML16FFS75BS	ML16FFS75BS143	ML16FFS75BS192	¾	16	13	-	¾-14	1	3.39	1.66	1.56	1.42	86	42	39.5	36	1.21	550
ML19FFS75	ML19FFS75143	ML19FFS75192	¾	19	15	¾-14	-	1	3.82	1.81	1.77	1.61	97	46	45	41	1.69	770
ML19FFS75BS	ML19FFS75BS143	ML19FFS75BS192	¾	19	15	-	¾-14	1	3.82	1.81	1.77	1.61	97	46	45	41	1.69	770
ML19FFS100	ML19FFS100143	ML19FFS100192	¾	19	15	1-11.5	-	1	3.80	1.82	1.77	1.61	97	46	45	41	1.56	710
ML19FFS100BS	ML19FFS100BS143	ML19FFS100BS192	¾	19	15	-	1-11	1	3.82	1.81	1.77	1.61	97	46	45	41	1.56	710
ML25FFS100BS	ML25FFS100BS143	ML25FFS100BS192	1	25	18	-	1-11	1	4.07	2.36	2.36	2.17	104	60	60	55	2.83	1290
ML25FFS125	ML25FFS125143	ML25FFS125192	1	25	18	1¼-11.5	-	1	4.07	2.36	2.36	2.17	104	60	60	55	2.83	1290
ML40FFS150	ML40FFS150143	-	1½	-	30.1	1½-11.5	-	1	5.01	3.13	2.76	2.56	127.4	79.5	70	65	6.16	2762
ML40FFS150BS	ML40FFS150BS143	-	1½	-	30.1	1½-11	1	5.01	3.13	2.76	2.56	127.4	79.5	70	65	6.13	2757	
-	ML50FFS200143	-	2	-	39.2	2-11.5	-	1	6.17	3.84	3.46	3.15	156.8	97.5	87.8	80	10.87	4883
-	ML50FFS200BS143	-	2	-	39.2	2-11	1	6.17	3.84	3.46	3.15	156.8	97.5	87.8	80	10.82	4861	

* Alternative end connections available upon request.

To obtain connected length of coupling, add dimensions A (Fig. 1) and G (Fig. 2) together.

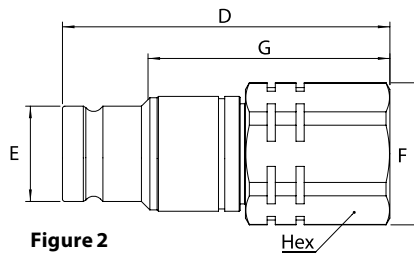

Figure 2

Plugs (Male)

Part Number		Body Size	ISO Size	Nominal Flow Diameter	Thread Size*(Female)		Dimensions											Weight		
NBR+AU	FKM	EPDM	(in)	(mm)	(mm)	NPT	BSPB	Fig.	D (in)	E (in)	F (in)	G (in)	Hex (in)	D (mm)	E (mm)	F (mm)	G (mm)	Hex (mm)	lbs	grams
ML6FFP2S	ML6FFP2S143	ML6FFP2S192	¼	6.3	6	¼-18	-	2	2.01	0.46	0.94	1.58	0.87	51	11.6	24	40.1	22	0.20	90
ML6FFP2SBS	ML6FFP2SBS143	ML6FFP2SBS192	¼	6.3	6	-	¼-19	2	2.01	0.46	0.94	1.58	0.87	51	11.6	24	40.1	22	0.20	90
ML10FFP37	ML10FFP37143	ML10FFP37192	¾	10	8.6	¾-18	-	2	2.56	0.78	1.16	1.97	1.06	65	19.7	29.5	50	27	0.33	150
ML10FFP37BS	ML10FFP37BS143	ML10FFP37BS192	¾	10	8.6	-	¾-19	2	2.56	0.78	1.16	1.97	1.06	65	19.7	29.5	50	27	0.33	150
ML10FFP50BS	ML10FFP50BS143	ML10FFP50BS192	¾	10	8.6	-	½-14	2	2.68	0.78	1.16	2.09	1.06	68	19.7	29.5	53	27	0.33	150
ML12FFP50	ML12FFP50143	ML12FFP50192	½	12.5	11	½-14	-	2	2.72	0.96	1.56	2.05	1.42	69	24.5	39.5	52	36	0.61	275
ML12FFP50BS	ML12FFP50BS143	ML12FFP50BS192	½	12.5	11	-	½-14	2	2.72	0.96	1.56	2.05	1.42	69	24.5	39.5	52	36	0.64	290
ML12FFP75BS	ML12FFP75BS143	ML12FFP75BS192	½	12.5	11	-	¾-14	2	2.83	0.96	1.56	2.17	1.42	72	24.5	39.5	55	36	0.61	275
ML16FFP75	ML16FFP75143	ML16FFP75192	¾	16	13	¾-14	-	2	2.83	1.06	1.56	1.42	1.42	72	27	39.5	36	36	0.69	315
ML16FFP75BS	ML16FFP75BS143	ML16FFP75BS192	¾	16	13	-	¾-14	2	2.83	1.06	1.56	1.42	1.42	72	27	39.5	36	36	0.69	315
ML19FFP75	ML19FFP75143	ML19FFP75192	¾	19	15	¾-14	-	2	3.70	1.18	1.77	2.83	1.61	94	29.9	45	72	41	1.28	580
ML19FFP75BS	ML19FFP75BS143	ML19FFP75BS192	¾	19	15	-	¾-14	2	3.70	1.18	1.77	2.83	1.61	94	29.9	45	72	41	1.28	580
ML19FFP100	ML19FFP100143	ML19FFP100192	¾	19	15	1-11.5	-	2	3.70	1.18	1.77	2.83	1.61	94	29.9	45	72	41	1.13	515
ML19FFP100BS	ML19FFP100BS143	ML19FFP100BS192	¾	19	15	-	1-11	2	3.70	1.18	1.77	2.83	1.61	94	29.9	45	72	41	1.12	510
ML25FFP100BS	ML25FFP100BS143	ML25FFP100BS192	1	25	18	-	1-11	2	4.12	1.42	2.36	2.17	2.17	104.6	36	60	55	55	2.37	1080
ML25FFP125	ML25FFP125143	ML25FFP125192	1	25	18	1¼-11.5	-	2	4.12	1.42	2.36	2.17	2.17	104.6	36	60	55	55	2.37	1080
ML40FFP150	ML40FFP150143	-	1½	-	30.1	1½-11.5	-	2	4.13	2.24	2.61	3.01	2.36	105	57	66.3	76.5	60	3.15	1411
ML40FFP150BS	ML40FFP150BS143	-	1½	-	30.1	1½-11	1	4.13	2.24	2.61	3.01	2.36	105	57	66.3	76.5	60	3.12	1398	
-	ML50FFP200143	-	2	-	39.2	2-11.5	-	2	5.31	2.87	3.29	3.80	2.95	135	73	83.5	96.6	75	6.01	2729
-	ML50FFP200BS143	-	2	-	39.2	2-11	2	5.31	2.87	3.29	3.80	2.95	135	73	83.5	96.6	75	5.97	2710	

* Alternative end connections available upon request.

To obtain connected length of coupling, add dimensions A (Fig. 1) and G (Fig. 2) together.

Color Coding Ring Option*

Body Size (in)	ISO Size (mm)	Size	Socket/Female Ring Part Number**				Plug/Male Ring Part Number**				Tool Part Number	Tool & Rings Kit Part Number***
			Blue	Red	Yellow	Green	Blue	Red	Yellow	Green		
¼	6	6FF	CR6FFSLB	CR6FFSRD	CR6FFSYL	CR6FFSDG	CR6FFPLB	CR6FFPRD	CR6FFPYL	CR6FFPDG	CR6FFSP93	CRKIT6FF
¾	10	10FF	CR10FFSLB	CR10FFSRD	CR10FFSYL	CR10FFSDG	CR10FFPLB	CR10FFPRD	CR10FFPYL	CR10FFPDG	CR10FFSP93	CRKIT10FF
½	12.5	12FF	CR12FFSLB	CR12FFSRD	CR12FFSYL	CR12FFSDG	CR12FFPLB	CR12FFPRD	CR12FFPYL	CR12FFPDG	CR12FFSP93	CRKIT12FF
¾	16	16FF	CR16FFSLB	CR16FFSRD	CR16FFSYL	CR16FFSDG	CR16FFPLB	CR16FFPRD	CR16FFPYL	CR16FFPDG	CR16FFSP93	CRKIT16FF
¾	19	19FF	CR19FFSLB	CR19FFSRD	CR19FFSYL	CR19FFSDG	CR19FFPLB	CR19FFPRD	CR19FFPYL	CR19FFPDG	CR19FFSP93	CRKIT19FF

For color coded rings TPE material is used that offers excellent flexibility which allows a very good shock resistance in demanding applications.

Good thermal, chemical and weather resistance provides a great fit on the coupling and a extended life time in toughest conditions.

The color coded rings are easy to install by using the referenced tools. Please refer to the user guide on "Danfoss.com"

* For requests on alternative colors or installation instructions, please contact your Danfoss sales representative.

** Orders must be in multiples of 10 pcs.

*** The kit consists of a tool plus 10 socket rings and 10 plug rings of each color.



Multi-FF

Fluid transfer & Hydraulic application



Danfoss Hansen Multi-FF system is designed for any application demanding multiple hydraulic fluid connections for power transmission. The system supports 2 to 6 flat face couplings simultaneously. The multiplate coupling system makes connectivity faster and simpler with a modular and flexible design. The configuration allows customized solutions with electrical connectors or specific couplings. The coupling body size has the ISO designation.

Product features

- Robust, reliable and easy to use
- Supports FF couplings sizes 6 through 25
- Couplings available in Zinc plated or 316L stainless steel
- Connectable under residual pressure
- Plates constructed in aluminium
- Modular design with customization of couplings, very configurable (FF, MLDB, ADB and in every size)

Application

- Mobile hydraulic, agriculture field
- Construction market
- Commercial vehicles

Physical Characteristics

MultiFF Part Number	No. Of coupling ports	Coupling type	Coupling body size	Pattern	Operating pressure	Seal	No. Of electrical port	No. Of contacts in electrical connector	End connection for couplings # #
4MFC-10CUP15LS11	4	FFCUP**	ISO 10	DLM122	250 bar	NBR	0	–	15L as per ISO 8434-1
4MFCE1-12CUP15L	4	FFCUP	ISO 12	Generic	350 bar	NBR	1	3#	15L as per ISO 8434-1
4MFC-12CUP15L	4	FFCUP	ISO 12	Generic	350 bar	NBR	0	–	15L as per ISO 8434-1
4MFC-1015L	4	FF*	ISO 10	Generic	350 bar	NBR	0	–	15L as per ISO 8434-1
4MFCE1-1015L	4	FF	ISO 10	Generic	350 bar	NBR	1	3	15L as per ISO 8434-1
6MFC-1015L	6	FF	ISO 10	Generic	350 bar	NBR	0	–	15L as per ISO 8434-1

*FF is ISO 16028 interchange flat face series coupling

**FFCUP is ISO 16028 interchange flat face series coupling with connect under residual pressure capability on plug side

No. Of contacts in each connector is configurable and connector can be provided with 3 to 12 number of contacts as per requirement

Other end connection styles and sizes are available.. See next page for list of end connection available for configuration. Contact Danfoss CSR for more information.

Note 1: This limited list of configurations is indicative only. Danfoss' Multi-FF solution is highly configurable and optimum solution can be provided to meet application requirements. Please contact Danfoss CSR for more information.

Flow Data

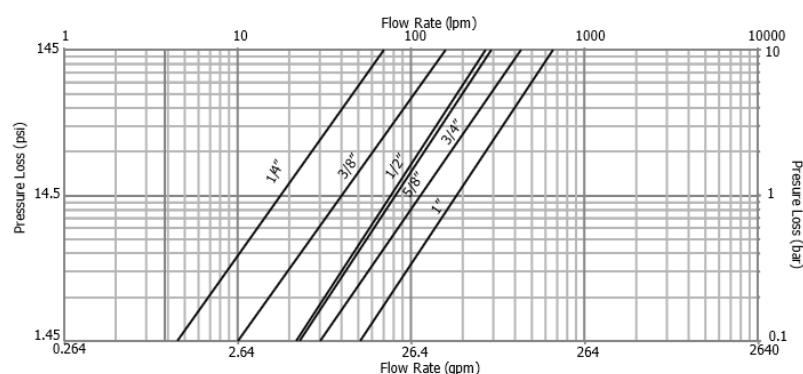

Note 2: This Flow chart is based on standard Flat face coupling configuration. Please contact Danfoss CSR for more information.

Multi-FF

Fluid transfer & Hydraulic application

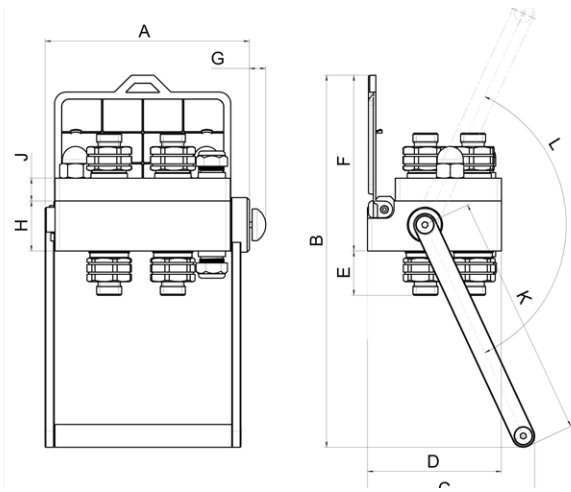

Figure 1

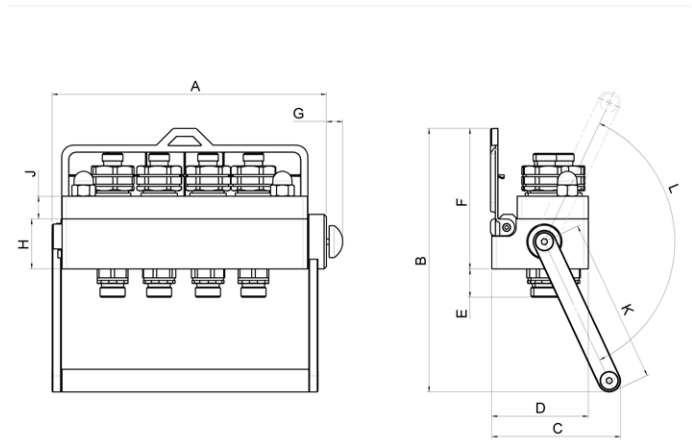

Figure 2

Dimensions

Part number	Fig.	A		B		C		D		E		F		G		H		J		K		L °
		mm	(in)	mm	(in)	mm	(in)	mm	(in)	mm	(in)	mm	(in)	mm	(in)	mm	(in)	mm	(in)	mm	(in)	
4MFC-10CUP15LS11	2	241	(9,4)	232	(9,1)	113	(4,4)	85	(3,3)	25	(0,9)	124	(4,8)	14	(0,5)	44	(1,7)	20	(0,7)	145	(5,7)	130°
4MFCE1-12CUP15L	1	180	(7,0)	327	(12,8)	147	(5,7)	118	(4,6)	39	(1,53)	155	(6,1)	14	(0,5)	44	(1,7)	20	(0,7)	215	(8,4)	130°
4MFC-12CUP15L	1	180	(7,0)	327	(12,8)	147	(5,7)	118	(4,6)	39	(1,53)	155	(6,1)	14	(0,5)	44	(1,7)	20	(0,7)	215	(8,4)	130°
4MFC-1015L	1	160	(6,2)	288	(11,3)	130	(5,1)	107	(4,2)	25	(0,9)	144	(5,6)	14	(0,5)	44	(1,7)	20	(0,7)	185	(7,2)	130°
4MFCE1-1015L	1	160	(6,2)	288	(11,3)	130	(5,1)	107	(4,2)	25	(0,9)	144	(5,6)	14	(0,5)	44	(1,7)	20	(0,7)	185	(7,2)	130°
6MFC-1015L	1	205	(8)	325	(9,2)	143	(5,6)	116	(4,5)	25	(0,9)	153	(6)	14	(0,5)	44	(1,7)	20	(0,7)	215	(8,4)	130°

Multi-FF

Configuration Multi-FF

4 MF C E1-12 ML 50BS 192 S11

Number of QDC

This digit specifies number of QDC's in a multi-FF set.

MF is family name for Danfoss' Multiplate solution.

Type of assembly

C: Complete set of Multi-FF system
P: Movable plate sub-assembly (attachment side)
S: Fixed plate sub-assembly (equipment side)

Electrical connector

This position indicates number of electrical connectors in particular Multi-FF system
(no code) = No electrical connector
E1 = 1 electrical connector
E2 = 2 electrical connectors
Etc.

QDC Body size

ISO size of QDC's used.

6 = 1/4"
10 = 3/8"
12 = 1/2"
16 = 5/8"
19 = 3/4"
25 = 1"

Product series code

This position is to define type of QDC being used in Multi-FF solution

- (no code) = Flat Face ISO 16028
- CUP = Flat Face Connect Under Pressure ISO 16028
- MLFF = SS version of ISO 16028 coupling
- MLDB = SS version of Dry Break coupling (water transfer etc.)
- ADB = Dry Break coupling in Aluminium (for cooling line etc.)
- G600 = Pneumatic application coupling

Danfoss internal code for special QDC pattern or configuration

Seal code

(no code) = NBR
143 = FKM
192 = EPDM
507 = HNBR
503 = FFKM
242 = Kalrez® 6375

End connection size and code

PT = NPT BS = BSPP
MET = Metric UN = UNF
L = ISO 8434-1 Light Duty
S = ISO 8434-1 Heavy Duty

End connection thread size

For BSPP, NPT, UN, UNF threads:

Fraction in inch x 100
1/4 = 25; 3/8 = 37; 1/2 = 50
5/8 = 62; 3/4 = 75; 1" = 100

For metric threads:

2 characters nominal thread size
e.g. M5 = 05; M10 = 10; M22 = 22

For ISO 8434-1 terminal end:

2 digits tube size per ISO 8434-1

FD49 Series

NFPA Standard T3.20.15 HTMA Interchange

Fluid transfer & Hydraulic application

Danfoss Hansen FD49 Series meets NFPA standard T3.20.15 and was developed in conjunction with HTMA (Hydraulic Tool Manufacturer's Association). Danfoss' Twin-Guard™ sealing system prevents weepage at low pressures and allows connection and disconnection against pressure up to 500 psi.



Product Features

- Dual flush face valving for minimal fluid loss and air inclusion
- Tubular valve and sleeve construction for high fluid flow with low pressure drop
- Push-to-connect latching for one hand operation
- Standard seal material: Teflon channel seal and Buna-N O-Ring backup
- Standard body material: High resistance carbon steel with zinc trivalent plating

Physical Characteristics

Body Size (in)	Max. Operating Pressure		Min. Burst Pressure Connected		Vacuum Connected Only	Rated Flow		Air Inclusion	Fluid Loss
	(bar)	(psi)	(bar)	(psi)	(in./Hg)	(lpm)	(gpm)	cc. max.	cc.max.
3/8	207	3,000	621	9,000	28	38	10	.01	.02

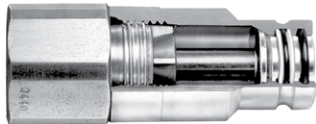

Danfoss' Twin-Guard™ seal system consists of channel and Buna-N O-Ring seals. The channel seal prevents blowout during connection and disconnection under pressure to 500 psi. The Buna-N O-Ring seal is a secondary seal eliminating fluid weepage.

Applications & Markets

- Hydraulic tool (HTMA interchange)
- Hydraulic and fluid transfer

Flow Data

Pressure Drop Versus Flow Graph

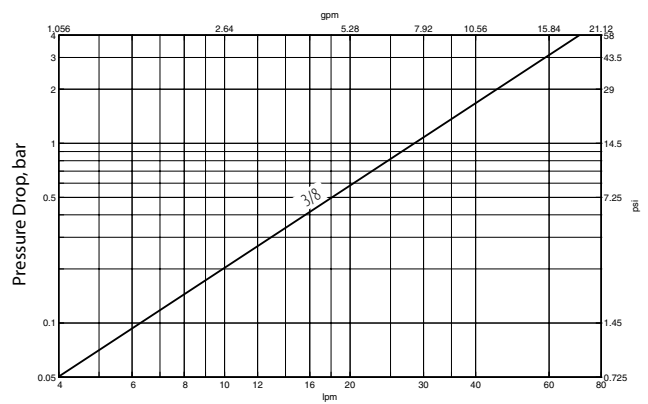

Gallons Per Minute Flow
Test Fluid: MIL-H-5606 Oil at 100°F

FD49 Series

NFPA Standard T3.20.15 HTMA Interchange

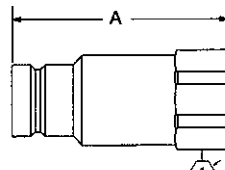

Figure 1

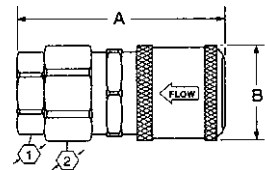

Figure 2

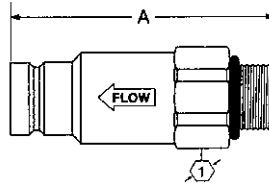

Figure 3

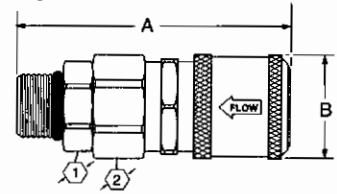

Figure 4

Dimensions (Female NPT, Valved)

Part Number Buna-N	Coupling Type	Body Size	Port Size	Thread	Type	Fig.	Dimensions A		B		Hex ①		Hex ②	
							mm	(in)	mm	(in)	mm	(in)	mm	(in)
FD49-1002-06-06	Plug/Male	3/8	3/8	3/8-18	Female NPT	1	66.5	(2.62)	-	-	25.4	(1.00)	-	-
FD49-1001-06-06	Socket/Female	3/8	3/8	3/8-18	Female NPT	2	69.6	(2.74)	30.5	(1.20)	25.4	(1.00)	26.9	(1.06)
FD49-1002-08-06	Plug/Male	3/8	1/2	1/2-14	Female NPT	1	69.9	(2.75)	-	-	26.9	(1.06)	-	-
FD49-1001-08-06	Socket/Female	3/8	1/2	1/2-14	Female NPT	2	72.4	(2.85)	30.5	(1.20)	-	-	26.9	(1.06)

Dimensions (Female SAE O-Ring, Valved)

Part Number Buna-N	Coupling Type	Body Size	Port Size	Thread	Type	Fig.	Dimensions A		B		Hex ①		Hex ②	
							mm	(in)	mm	(in)	mm	(in)	mm	(in)
FD49-1004-08-06	Plug/Male	3/8	3/4	3/4-16	Female SAE O-Ring	1	69.9	(2.75)	-	-	26.9	(1.06)	-	-
FD49-1005-08-06	Socket/Female	3/8	3/4	3/4-16	Female SAE O-Ring	2	71.6	(2.82)	30.5	(1.20)	-	-	26.9	(1.06)

Dimensions (Male SAE O-Ring, Valved)

Part Number Buna-N	Coupling Type	Body Size	Port Size	Thread	Type	Fig.	Dimensions A		B		Hex ①		Hex ②	
							mm	(in)	mm	(in)	mm	(in)	mm	(in)
FD49-1057-06-06	Plug/Male	3/8	9/16	9/16-18	Male SAE O-Ring	3	75.9	(2.99)	-	-	25.4	(1.00)	-	-
FD49-1014-06-06	Socket/Female	3/8	9/16	9/16-18	Male SAE O-Ring	4	81.8	(3.22)	30.5	(1.20)	25.4	(1.00)	26.9	(1.06)
FD49-1057-08-06	Plug/Male	3/8	3/4	3/4-16	Male SAE O-Ring	3	75.9	(2.99)	-	-	25.4	(1.00)	-	-
FD49-1014-08-06	Socket/Female	3/8	3/4	3/4-16	Male SAE O-Ring	4	83.3	(3.28)	30.5	(1.20)	25.4	(1.00)	26.9	(1.06)

Dust Cap/Plug, Standard Coupling

Part Number Buna-N	Body Size
FD49-1042-06	3/8

Note: Fits male and female halves.



Dust Cap/Plug

FD96 Series

High Pressure Thread to Connect Flush Face

Fluid transfer & Hydraulic application



Danfoss Hansen FD96 High Pressure Thread Together Flush Face Series is designed for high pressure and high impulse applications for hydraulic circuits. The FD96 Series design provides low connect and disconnect force in hydraulic circuits where trapped residual pressure must be addressed. The flush face design limits contamination and unwanted fluid loss. The FD96 Series is available in sizes ¼" through 2" to best meet your specific size requirements.

Product Features

- Thread together design allows connection and disconnection under pressure up to 4,300 psi
- Low connection force
- Dual flush-face valving with non-spill design
- Working pressures up to 8,700 psi
- Body material: High-resistance carbon steel with zinc trivalent and black oxide plating

Applications & Markets

- Hydraulic Fluid Transfer
- High-impulse Hydraulics
- Oilfields
- Mining

Physical Characteristics

Body Size	Max. Operating Pressure					Min. Burst Pressure					Rated Flow (lpm)	Fluid Loss (gpm)	cc.	Req. Torque to Connect			
	Connected		Plug/Male Half		Socket/Female Half		Connected		Plug/Male Half					Socket/Female Half		lbs.	(N)
	(bar)	(psi)	(bar)	(psi)	(bar)	(psi)	(bar)	(psi)	(bar)	(psi)				(bar)	(psi)		
¼	600	8,700	600	8,700	420	6,090	1,500	21,750	1,500	21,750	1,260	18,270	12	3.2	.012	29-37	40-50
⅜	550	7,980	550	7,980	330	4,785	1,400	20,300	1,400	20,300	1,000	14,500	23	6.1	.040	37-44	50-60
½	550	7,980	550	7,980	330	4,785	1,400	20,300	1,400	20,300	1,000	14,500	45	11.9	.025	48-55	65-75
¾	550	7,980	550	7,980	330	4,785	1,400	20,300	1,400	20,300	1,000	14,500	74	19.6	.033	52-59	70-80
1	500	7,250	500	7,250	330	4,785	1,250	18,125	1,250	18,125	1,000	14,500	100	26.5	.018	66-81	90-110
1¼	470	6,800	470	6,800	300	4,350	1,200	17,400	1,200	17,400	800	11,600	189	50.1	.060	92-107	125-145
1½	400	5,800	400	5,800	270	3,915	1,700	15,950	1,100	15,950	800	11,600	288	76.3	.200	114-129	155-175
2	350	5,080	350	5,080	270	3,915	1,100	15,950	1,100	15,950	800	11,600	379	100.4	.350	236-258	320-355

Flow Data

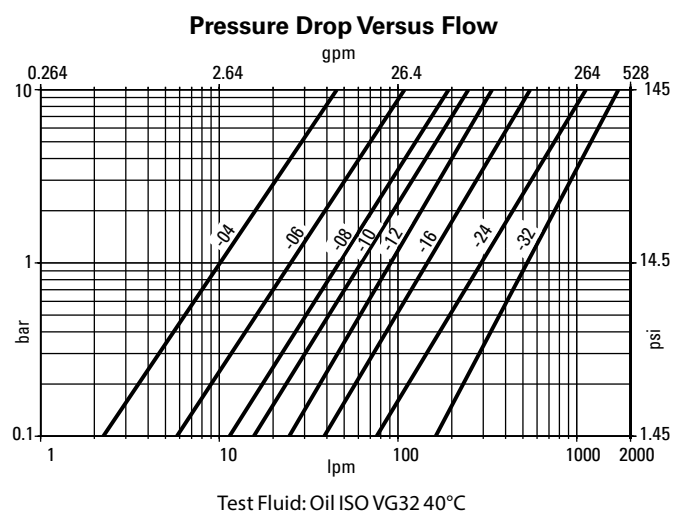

Connected Length

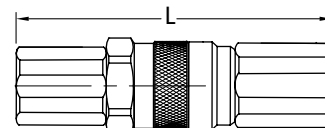

Body Size	Port Size	Connected Length "L"	
		mm	(in)
¼	⅜	90.0	(3.54)
⅜	⅜	131.0	(5.16)
⅜	½	131.0	(5.16)
½	½	155.0	(6.10)
½	¾	160.0	(6.30)
¾	¾	165.0	(6.50)
1	1	190.4	(7.50)
1	1¼	170.0	(6.69)
1½	1½	256.0	(10.08)
2	2	363.5	(14.31)

FD96 Series

High Pressure Thread to Connect Flush Face

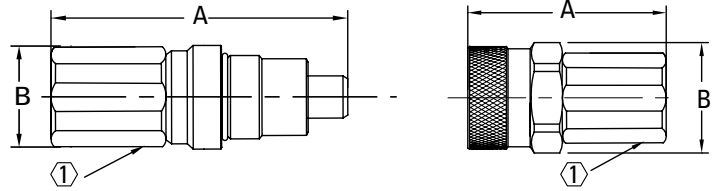

Figure 1

Figure 2

Dimensions (Female NPT)

Part Number	Coupling Type	Body Size	Port Size	Thread	Type	Fig.	Dimensions A		B		Hex ①	
							mm	(in)	mm	(in)	mm	(in)
FD96-1001-06-06	Socket/Female	¾	¾	¾-18	Female NPT	2	65.8	(2.59)	41.8	(1.65)	30	(1.18)
FD96-1002-06-06	Plug/Male	¾	¾	¾-18	Female NPT	1	82.5	(3.25)	37.8	(1.49)	27	(1.06)
FD96-1001-08-06	Socket/Female	¾	½	½-14	Female NPT	2	70.8	(2.79)	41.8	(1.65)	30	(1.18)
FD96-1002-08-06	Plug/Male	¾	½	½-14	Female NPT	1	85.0	(3.35)	37.8	(1.49)	27	(1.06)
FD96-1001-08-08	Socket/Female	½	½	½-14	Female NPT	2	77.8	(3.06)	49.8	(1.96)	36	(1.42)
FD96-1002-08-08	Plug/Male	½	½	½-14	Female NPT	1	95.0	(3.74)	45.8	(1.80)	36	(1.42)
FD96-1001-12-08	Socket/Female	½	¾	¾-14	Female NPT	2	84.8	(3.06)	49.8	(1.96)	36	(1.42)
FD96-1002-12-08	Plug/Male	½	¾	¾-14	Female NPT	1	97.4	(3.83)	45.8	(1.80)	36	(1.42)
FD96-1001-12-12	Socket/Female	¾	¾	¾-14	Female NPT	2	84.9	(3.34)	53.8	(2.12)	41	(1.61)
FD96-1002-12-12	Plug/Male	¾	¾	¾-14	Female NPT	1	99.0	(3.90)	49.8	(1.96)	36	(1.42)
FD96-1001-12-16	Socket/Female	1	¾	¾-14	Female NPT	2	96.7	(3.81)	58.8	(2.31)	46	(1.81)
FD96-1002-12-16	Plug/Male	1	¾	¾-14	Female NPT	1	113.6	(4.47)	54.8	(2.16)	46	(1.81)
FD96-1001-16-16	Socket/Female	1	1	1-11 ½	Female NPT	2	99.7	(3.93)	58.8	(2.31)	46	(1.81)
FD96-1002-16-16	Plug/Male	1	1	1-11 ½	Female NPT	1	113.6	(4.47)	54.8	(2.16)	46	(1.81)
FD96-1001-16-20	Socket/Female	1¼	1	1-11 ½	Female NPT	2	105.8	(4.17)	69.8	(2.75)	55	(2.17)
FD96-1002-16-20	Plug/Male	1¼	1	1-11 ½	Female NPT	1	123.4	(4.86)	64.5	(2.54)	55	(2.17)
FD96-1001-20-20	Socket/Female	1¼	1¼	1¼-11 ½	Female NPT	2	106.8	(4.20)	69.8	(2.75)	55	(2.17)
FD96-1002-20-20	Plug/Male	1¼	1¼	1¼-11 ½	Female NPT	1	123.4	(4.86)	64.5	(2.54)	55	(2.17)
FD96-1001-20-24	Socket/Female	1½	1¼	1¼-11 ½	Female NPT	2	133.5	(5.26)	92.0	(3.62)	65	(2.56)
FD96-1002-20-24	Plug/Male	1½	1¼	1¼-11 ½	Female NPT	1	150.0	(5.91)	89.8	(3.54)	65	(2.56)
FD96-1001-24-24	Socket/Female	1½	1½	1½-11 ½	Female NPT	2	133.5	(5.26)	92.0	(3.62)	65	(2.56)
FD96-1002-24-24	Plug/Male	1½	1½	1½-11 ½	Female NPT	1	150.0	(5.91)	89.8	(3.54)	65	(2.56)
FD96-1001-32-32	Socket/Female	2	2	2-11 ½	Female NPT	2	224.8	(8.85)	200.0	(7.87)	90	(3.54)
FD96-1002-32-32	Plug/Male	2	2	2-11 ½	Female NPT	1	218.4	(8.60)	145.0	(5.71)	90	(3.54)

Dimensions (Female SAE O-Ring)

Part Number	Coupling Type	Body Size	Port Thread	Type	Fig.	Dimensions A		B		Hex ①		
						mm	(in)	mm	(in)	mm	(in)	
FD96-1004-06-04	Socket/Female	¼	¾	¾-18 UNF	Female SAE O-Ring	2	57.1	(2.25)	38.8	(1.53)	27	(1.06)
FD96-1005-06-04	Plug/Male	¼	¾	¾-18 UNF	Female SAE O-Ring	1	72.8	(2.87)	34.8	(1.37)	22	(.87)
FD96-1004-08-06	Socket/Female	¾	½	¾-16 UNF	Female SAE O-Ring	2	70.8	(2.79)	41.8	(1.65)	30	(1.18)
FD96-1005-08-06	Plug/Male	¾	½	¾-16 UNF	Female SAE O-Ring	1	87.0	(3.43)	37.8	(1.49)	27	(1.06)
FD96-1004-12-08	Socket/Female	½	¾	1¼-12 UNF	Female SAE O-Ring	2	84.8	(3.06)	49.8	(1.96)	36	(1.42)
FD96-1005-12-08	Plug/Male	½	¾	1¼-12 UNF	Female SAE O-Ring	1	100.4	(3.95)	45.8	(1.80)	36	(1.42)
FD96-1004-12-12	Socket/Female	¾	¾	1¼-12 UNF	Female SAE O-Ring	2	84.9	(3.34)	53.8	(2.12)	41	(1.61)
FD96-1005-12-12	Plug/Male	¾	¾	1¼-12 UN	Female SAE O-Ring	1	102.0	(4.02)	49.8	(1.96)	36	(1.42)
FD96-1004-12-16	Socket/Female	1	¾	1¼-12 UN	Female SAE O-Ring	2	99.7	(3.93)	58.8	(2.31)	46	(1.81)
FD96-1005-12-16	Plug/Male	1	¾	1¼-12 UN	Female SAE O-Ring	1	115.6	(4.55)	54.8	(2.16)	46	(1.81)
FD96-1004-16-16	Socket/Female	1	1	1½-12 UN	Female SAE O-Ring	2	99.7	(3.93)	58.8	(2.31)	46	(1.81)
FD96-1005-16-16	Plug/Male	1	1	1½-12 UN	Female SAE O-Ring	1	113.6	(4.47)	54.8	(2.16)	46	(1.81)
FD96-1004-16-20	Socket/Female	1¼	1	1½-12 UN	Female SAE O-Ring	2	105.8	(4.17)	69.8	(2.75)	55	(2.17)
FD96-1005-16-20	Plug/Male	1¼	1	1½-12 UN	Female SAE O-Ring	1	125.4	(4.94)	64.5	(2.54)	55	(2.17)
FD96-1004-20-20	Socket/Female	1¼	1¼	1½-12 UN	Female SAE O-Ring	2	106.8	(4.20)	69.8	(2.75)	55	(2.17)
FD96-1005-20-20	Plug/Male	1¼	1¼	1½-12 UN	Female SAE O-Ring	1	123.4	(4.86)	64.5	(2.54)	55	(2.17)
FD96-1004-20-24	Socket/Female	1½	1¼	1½-12 UN	Female SAE O-Ring	2	133.5	(5.26)	92.0	(3.62)	65	(2.56)
FD96-1005-20-24	Plug/Male	1½	1¼	1½-12 UN	Female SAE O-Ring	1	150.0	(5.91)	89.8	(3.54)	65	(2.56)
FD96-1004-24-24	Socket/Female	1½	1½	1½-12 UN	Female SAE O-Ring	2	133.5	(5.26)	92.0	(3.62)	65	(2.56)
FD96-1005-24-24	Plug/Male	1½	1½	1½-12 UN	Female SAE O-Ring	1	150.0	(5.91)	89.8	(3.54)	65	(2.56)

Dust Caps and Dust Plugs

Body Size	Part Number	Coupling Type	Cap Material	Body Size	Part Number	Coupling Type	Cap Material
¼	FD96-1009-04	Socket/Female	Aluminum	¼	FD96-1010-04	Plug/Male	Aluminum
¾	FD96-1009-06	Socket/Female	Aluminum	¾	FD96-1010-06	Plug/Male	Aluminum
½	FD96-1009-08	Socket/Female	Aluminum	½	FD96-1010-08	Plug/Male	Aluminum
¾	FD96-1009-12	Socket/Female	Aluminum	¾	FD96-1010-12	Plug/Male	Aluminum
1	FD96-1009-16	Socket/Female	Aluminum	1	FD96-1010-16	Plug/Male	Aluminum
1¼	FD96-1009-20	Socket/Female	Aluminum	1¼	FD96-1010-20	Plug/Male	Aluminum
1½	FD96-1009-24	Socket/Female	Aluminum	1½	FD96-1010-24	Plug/Male	Aluminum
2	FD96-1009-32	Socket/Female	Aluminum	2	FD96-1010-32	Plug/Male	Aluminum

K8000 Series

Fluid transfer & Hydraulic application

Danfoss Hansen K8000 series hydraulic screw-to-connect quick disconnect coupling is best for applications where vibration is present and a threaded solution is needed to lock in place.



Product Features

- Connection by screwing up the locking sleeve
- Offers internal flat face valve to minimize air inclusion and fluid loss
- Proprietary interchange
- Standard body material: Zinc trivalent plated steel
- Standard seal material: Buna-N

Physical Characteristics

DN/ND	Max. Operating Pressure		Rated Flow		Air Inclusion	
	(bar)	(psi)	(bar)	(gpm)	ml max.	
8	250	3,625	12	3.17	0.09	

Applications & Markets

- Agriculture and Forestry Equipment

Flow Data

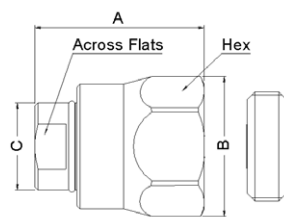
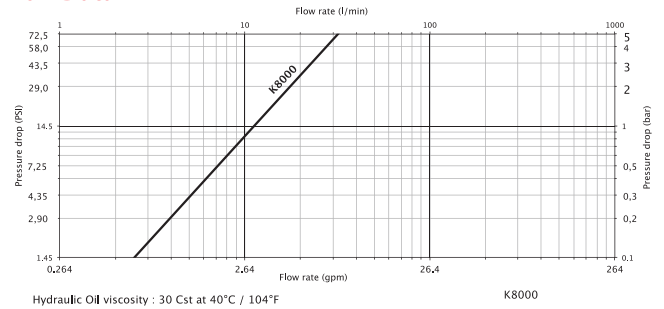

Figure 1

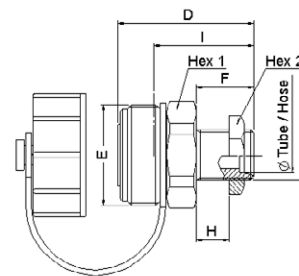

Figure 2

DN/ND	Socket and Dust Plug	Socket Dust Plug Only	Coupling Type	Connection	Fig.	A	Dimensions B	C	Across Flats	Hex				
						(mm)	(mm)	(mm)	(mm)	(mm)				
8	KA0832718	KA0812700	Socket/Female	M18X150	1	55	45.1	27.9	23	41				
DN/ND	Plug and Dust Cap	Plug Dust Cap Only	Coupling Type	Connection	Fig.	D	Dimensions E	F	G	H	I	Tube	Hex1	Hex2
						(mm)	(mm)	(mm)	(mm)	(mm)	(mm)	(mm)	(mm)	
	KA0832412		Plug/Male	M18X150	2	52	36	23	M18X1,50	5	38	12	36	27
8	KA0832413	KP0812400	Plug/Male	M20X150	2	51	36	23	M20X1,50	5	37	13	36	27
	KA0802412		Plug/Male	G½*	2	48	36	15	G ½-14*	-	34	-	36	-

Q9000 Series

Fluid transfer & Hydraulic application

Danfoss Hansen Q9000 Series is a brake away coupling used on agriculture and forestry vehicles.



Product Features

- Pull-to-connect double shut off
- Minimum air inclusion and fluid loss
- Profile in accordance to ISO 5676 and NFU 16-006 standards
- Standard seal material: NBR
- Standard body material: Zinc trivalent plated steel

Physical Characteristics

DN/ND	Max. Operating Pressure		Rated Flow		Air Inclusion	
	(bar)	(psi)	(bar)	(gpm)	ml max.	
8	150	2,175	19	5.02	0.80	

Applications & Markets

- Trailer Brake Circuits on Agriculture and Forestry Vehicles

Flow Data

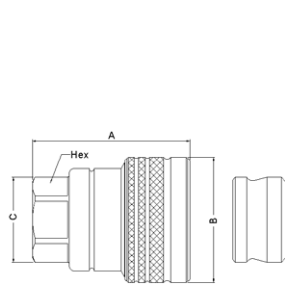
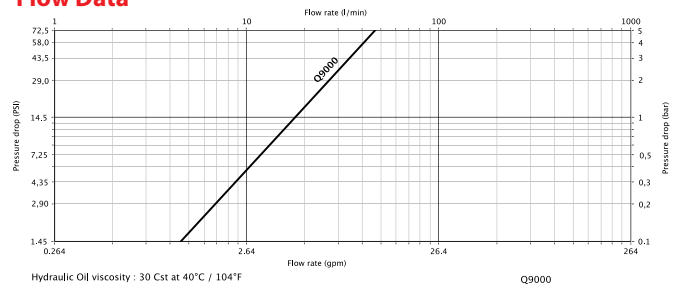

Figure 1

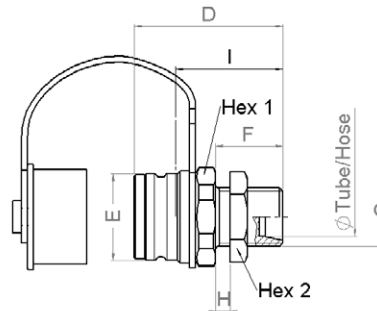

Figure 2

DN/ND	Socket and Dust Plug	Socket Dust Plug Only	Coupling Type	Connection	Fig.	A	Dimensions						
(mm)						(mm)	B	C	Hex				
8	QA0932118	QA0912100	Socket/Female	M18X150	1	55.5	44	30.2		27			
DN/ND	Plug and Dust Cap	Plug Dust Cap Only	Coupling Type	Connection	Fig.	D	Dimensions			Hex 1	Hex 2		
(mm)						(mm)	E	F	G	H	I	(mm)	(mm)
8	QA0932212	QP0912200	Plug/Male	M18X150	2	49	30	21	M18x1,50	5	34	32	24
	QA0932213		Plug/Male	M20X150	2	51.0	30	23	M20x1,50	5	36	32	27

MLDB Series (Stainless Steel)

Flat Face/Dry Break

Fluid transfer & Hydraulic application



Danfoss Hansen MLDB Series stainless steel coupling is a flat face/dry break coupling used for fluid transfer applications. The MLDB Series offers the ability to connect with less force, higher sealing performance and are available in multiple configurable end connections.

Product Features

- Designed and manufactured in accordance with Article 4.3 of the European Pressure Equipment Directive PED 2014/68/EU
- Safety sleeve lock prevents accidental disconnections
- Push to connect with double shut-off valving
- Capable of working under high temperature applications
- Shock-resistant color coding ring option available in 1/2" size
- Serviceable design allows for easy cleaning and seal replacement
- Designed with higher flow capacity and resistance to aggressive fluids and corrosion
- Standard body material: 316/316L Stainless steel corrosion resistant
- Standard seal material: FKM, EPDM, Kalrez® and generic FFKM

Physical Characteristics

Body Size (in)	Nominal Flow Diameter (mm)	Max. Operating Pressure (bar)	(psi)	Rated* Flow (lpm)	(gpm)	Air Inclusion ml-cc.	Fluid Loss ml-cc.	Force to Connect N	lbf
¼	5.9	25	360	15	4	0.002	0.001	85	19
½	11.5	25	360	73	19	0.012	0.025	150	34
¾	15.0	25	360	120	32	0.030	0.050	170	38
1	18.5	25	360	200	53	0.150	0.130	180	41

* Indicated values refer to a 1 bar/14.5 psi pressure drop.

Applications & Markets

- Process/Fluid Transfer
- Cooling
- Corrosive Environments
- Chemicals/Petrochemicals
- Pharmaceuticals
- Food Processing
- Electrical

Flow Data

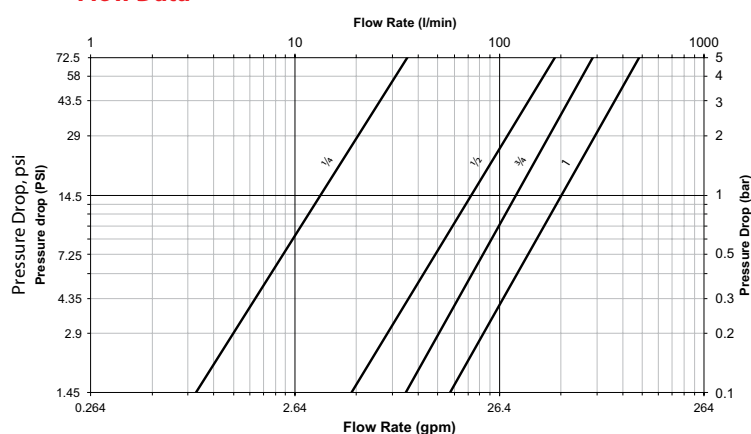

Test Fluid: Oil viscosity 30 cSt at 40°C/104°F

Seal Elastomer Data*

Seal Elastomer	Max. Operation Temperature Range
FKM	-20°C +200°C/-4°F +392°F
EPDM (Ethylene-Propylene)	-40°C +150°C/-40°F +302°F
Kalrez® 6375	-20°C +275°C/-4°F +527°F
Generic FFKM (Perfluorocarbon)	-15°C +275°C/+5°F +527°F

* For reference only, based on Danfoss recommended temperatures.

Contact Danfoss technical support for further information on fluid compatibility

MLDB Series (Stainless Steel)

Flat Face/Dry Break

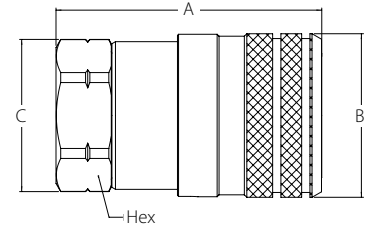

Figure 1

Sockets (Female)

Part Number		Thread Size*(Female)			Dimensions							Weight					
FKM	EPDM	Kalrez 6375	Generic FFKM	Body Size	NPT	BSP	Fig.	A (in)	B (in)	C (in)	Hex (in)	A (mm)	B (mm)	C (mm)	Hex (mm)	lbs	grams
ML2DBS25FBS	ML2DBS25FBS292	ML2DBS25FBS242	ML2DBS25FBS503	¼	-	¼-19	1	1.79	1.06	0.96	0.87	45.4	26.8	24.5	22	0.25	116
ML2DBS25F	ML2DBS25F292	ML2DBS25F242	ML2DBS25F503	¼	¼-18		1	1.73	1.06	0.96	0.87	43.9	26.8	24.5	22	0.27	127
ML4DBS50FBS	ML4DBS50FBS292	ML4DBS50FBS242	ML4DBS50FBS503	½	-	½-14	1	2.44	1.5	1.4	1.26	61.9	38.2	35.5	32	0.71	325
ML4DBS50F	ML4DBS50F292	ML4DBS50F242	ML4DBS50F503	½	½-14		1	2.44	1.5	1.4	1.26	61.9	38.2	35.5	32	0.70	318
ML6DBS75FBS	ML6DBS75FBS292	ML6DBS75FBS242	ML6DBS75FBS503	¾	-	¾-14	1	3.02	1.89	1.83	1.61	76.8	47.9	46.5	41	1.36	617
ML6DBS75F	ML6DBS75F292	ML6DBS75F242	ML6DBS75F503	¾	¾-14		1	3.02	1.89	1.83	1.61	76.8	47.9	46.5	41	1.37	622
ML8DBS100FBS	ML8DBS100FBS292	ML8DBS100FBS242	ML8DBS100FBS503	1	-	1-11	1	3.54	2.26	2.16	1.97	89.9	57.4	54.9	50	2.21	1005
ML8DBS100F	ML8DBS100F292	ML8DBS100F242	ML8DBS100F503	1	1-11		1	3.42	2.26	2.16	1.97	86.9	57.4	54.9	50	2.24	1020

*Alternative end connections available upon request.

To obtain connected length of coupling, add dimensions A (Fig. 1) and G (Fig. 2) together.

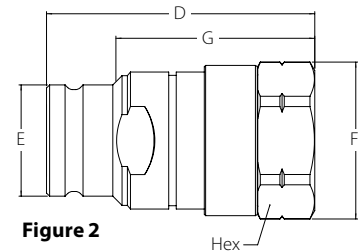

Figure 2

Plugs (Male)

Part Number		Thread Size*(Female)			Dimensions							Weight							
FKM	EPDM	Kalrez 6375	Generic FFKM	Body Size	NPT	BSP	Fig.	D (in)	E (in)	F (in)	G (in)	Hex (in)	D (mm)	E (mm)	F (mm)	G (mm)	Hex (mm)	lbs	grams
ML2DBP25FBS	ML2DBP25FBS292	ML2DBP25FBS242	ML2DBP25FBS503	¼	-	¼-19	2	1.72	0.65	0.96	1.31	0.87	43.6	16.5	24.5	33.2	22	0.17	80
ML2DBP25F	ML2DBP25F292	ML2DBP25F242	ML2DBP25F503	¼	¼-18		2	1.66	0.65	0.96	1.25	0.87	42.1	16.5	24.5	31.7	22	0.18	82
ML4DBP50FBS	ML4DBP50FBS292	ML4DBP50FBS242	ML4DBP50FBS503	½	-	½-14	2	2.39	0.99	1.4	1.8	1.26	60.7	25.2	35.5	45.7	32	0.44	204
ML4DBP50F	ML4DBP50F292	ML4DBP50F242	ML4DBP50F503	½	½-14		2	2.39	0.99	1.4	1.8	1.26	60.7	25.2	35.5	45.7	32	0.47	214
ML6DBP75FBS	ML6DBP75FBS292	ML6DBP75FBS242	ML6DBP75FBS503	¾	-	¾-14	2	2.97	1.29	1.83	2.11	1.61	75.5	32.8	46.5	53.6	41	0.92	418
ML6DBP75F	ML6DBP75F292	ML6DBP75F242	ML6DBP75F503	¾	¾-14		2	2.97	1.29	1.83	2.11	1.61	75.5	32.8	46.5	53.6	41	0.90	409
ML8DBP100FBS	ML8DBP100FBS292	ML8DBP100FBS242	ML8DBP100FBS503	1	-	1-11	2	3.52	1.59	2.16	2.60	1.97	89.4	40.4	54.9	66.1	50	1.61	733
ML8DBP100F	ML8DBP100F292	ML8DBP100F242	ML8DBP100F503	1	1-11		2	3.4	1.59	2.16	2.48	1.97	86.4	40.4	54.9	63.1	50	1.54	700

Seal Kit and Tool for Servicing Sockets (Female)

Body Size	Tool Part Number	Seal Kit Part Number (includes 5 sets)		Seal Kit Part Number (includes 1 set)	
		FKM	EPDM	Kalrez 6375	Generic FFKM
¼	ML2DBS93	2DBSG143	2DBSG292	2DBSG242	2DBSG503
½	ML4DBS93	4DBSG143	4DBSG292	4DBSG242	4DBSG503
¾	ML6DBS93	6DBSG143	6DBSG292	6DBSG242	6DBSG503
1	ML8DBS93	8DBSG143	8DBSG292	8DBSG242	8DBSG503

For installation instructions, please refer to the user guide on "Danfoss.com".

Seal Kit for Servicing Plugs (Male)

Body Size	Seal Kit Part Number (includes 5 sets)		Seal Kit Part Number (includes 1 set)	
	FKM	EPDM	Kalrez 6375	Generic FFKM
¼	2DBPG143	2DBPG292	2DBPG242	2DBPG503
½	4DBPG143	4DBPG292	4DBPG242	4DBPG503
¾	6DBPG143	6DBPG292	6DBPG242	6DBPG503
1	8DBPG143	8DBPG292	8DBPG242	8DBPG503



Color Coding Ring Option*

Body Size (in)	ISO Size (mm)	Size	Socket/Female Ring Part Number**				Plug/Male Ring Part Number**				Tool Part Number	Tool & Rings Kit Part Number***
			Blue	Red	Yellow	Green	Blue	Red	Yellow	Green		
½	12.5	12FF	CR12FFSLB	CR12FFSRD	CR12FFSYL	CR12FFSDG	CR12FFPLB	CR12FFPRD	CR12FFPYL	CR12FFPDG	CR12FFSP93	CRKIT12FF

For color coded rings TPE material is used that offers excellent flexibility which allows a very good shock resistance in demanding applications. Good thermal, chemical and weather resistance provides a great fit on the coupling and an extended life time in toughest conditions. The color coded rings are easy to install by using the referenced tools. Please refer to the user guide on "Danfoss.com"

* For requests on alternative colors or installation instructions, please contact your Danfoss sales representative.

** Orders must be in multiples of 10 pcs.

*** The kit consists of a tool plus 10 socket rings and 10 plug rings of each color.

Safe Breakaway Series

Fluid transfer & Hydraulic application

Danfoss' Safe Breakaway series is a coupling made for liquified gas transfer within railway, marine or truck transportation. In the event of accidental disconnection, the coupling will automatically and instantaneously close to prevent any leakage of hazardous chemicals or gases.



Product Features

- Dry disconnection function prevents loss of fluid
- Safety feature integrated to close flow path when vehicle is accidently moving during fluid transfer
- Standard seal material: EPDM

Application

- Fluid transfer (liquified gas)
- Railway, Marine or on highway transportation vehicles
- Standard body material: Stainless steel EN 1.4418

Physical characteristics

Body Size	Max Operating Pressure		Nominal Flow Diameter	Plug part number	Socket part number	Tube size	Socket dimensions (Fig. 1)		Plug dimensions (Fig. 2)		Length connected
	(in)	(bar)					(psi)	(mm)	(in)	A (mm)	
2	16	232	50	QV19782E0	QX19781E0	2	130,5	126	161,5	145	239
3	16	232	80	QV19792E0	QX19791E0	3	148	160	190	188,5	272

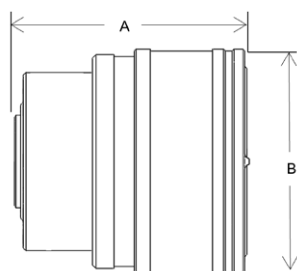

Figure 1: socket part

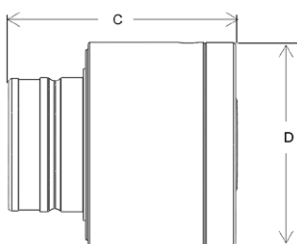
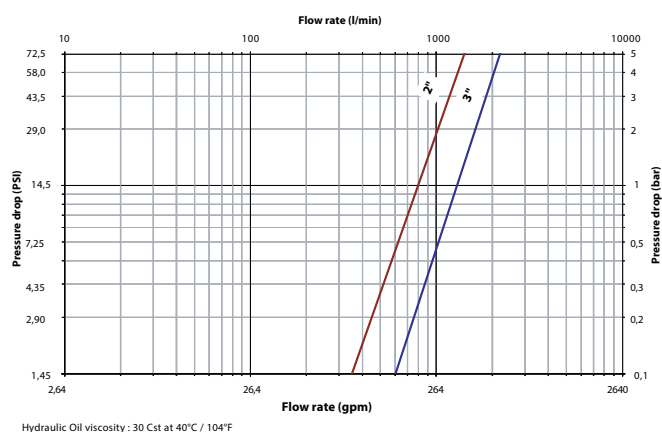

Figure 2: plug part

Flow Data



W36000 Series

Thread-to-Connect

Fluid transfer & Hydraulic application



Danfoss Hansen W36000 Series is a screw-to-connect quick disconnect coupling. Due to its design and the materials used, the W36000 Series quick disconnect coupling has excellent resistance to mechanical and hydraulic applications where vibration is present. The inner components of sizes 3/4", 1" & 1 1/4" have a robust construction to withstand the harsh application needs. Additionally, the plug sleeve ensures protection of the sealing area upon disconnection.

Product Features

- Designed and manufactured in accordance with Article 4.3 of the European Pressure Equipment Directive PED 2014/68/EU
- Proprietary profile
- Thread-to-connect with double shut-off valving
- Can be connected against 50 bar (725 psi) residual pressure
- Optional dust caps and plugs (PVC or aluminum)
- An alternative version can be offered with a safety feature which minimizes the risk of unscrewing in conditions of heavy vibration
- O-ring indication allows checking that connection is complete (thus guaranteeing full flow)
- Standard body material: Zinc trivalent plated steel
- Standard seal material: NBR

Physical Characteristics

Body Size (in)	Nominal Flow Diameter (mm)	Max. Operating Pressure		Max. Residual Pressure during Connection		Rated Flow*	
		bar	(psi)	bar	(psi)	L/min	(gpm)
1/4	5.3	450	6525	50	725	12	3.17
3/8	7.3	450	6525	50	725	21	5.55
1/2	10.2	400** 250***	5800** 3625***	50	725	43	11.36
3/4	13.0	400	5800	50	725	77	20.34
1	16.9	300	4350	50	725	120	31.70
1 1/4	22.4	300	4350	50	725	300	79.25

* Indicated values refer to a 1 bar / 14.5 psi pressure drop.

** Operating pressures apply to BSPP and NPT threads.

*** For ISO 8434-1 end connections.

Applications & Markets

- Construction
- Agriculture
- Forestry Machinery
- Snow-grooming Machines

Flow Data

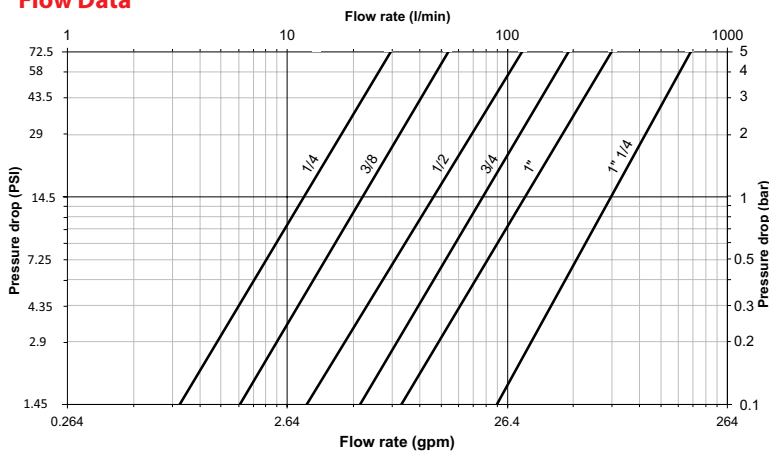

Seal Elastomer Data*

Seal Elastomer	Max. Operation Temperature Range
NBR (Nitrile)	-20°C +100°C / -4°F +212°F

* For reference only, based on Danfoss recommended temperatures.

Contact Danfoss technical support for further information on fluid compatibility.

W36000 Series Thread-to-Connect

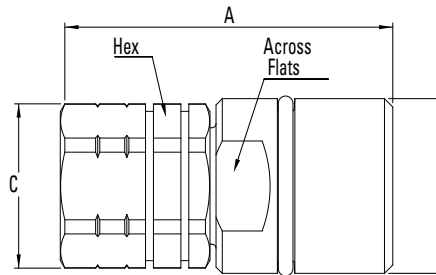

Figure 1

Sockets (Female) with Internal Thread

Part Number*	Body Size	Nominal Flow Diameter	Thread Size* (Female)	Dimensions												Weight	
				NBR	(in)	(mm)	NPT	BSPB	Fig.	A (in)	B (in)	C (in)	Across Flats (in)	Hex (in)	A (mm)	B (mm)	C (mm)
WA3601700	¼	5.3	-	¼-19	1	2.28	0.94	0.94	0.87	0.87	58	M24x2	24	22	22	0.26	117
WA3621725	¼	5.3	¼-18	-	1	2.28	0.94	0.94	0.87	0.87	58	M24x2	24	22	22	0.30	138
WA3602725BS	¾	7.3	-	¼-19	1	2.40	1.10	0.94	0.94	0.87	61	M28x2	24	24	22	0.36	163
WA3622725	¾	7.3	¼-18	-	1	2.40	1.10	0.94	0.94	0.87	61	M28x2	24	24	22	0.36	165
WA3602700	¾	7.3	-	¾-19	1	2.40	1.10	0.94	0.94	0.87	61	M28x2	24	24	22	0.34	156
WA3622737	¾	7.3	¾-18	-	1	2.40	1.10	0.94	0.94	0.87	61	M28x2	24	24	22	0.35	158
WA3603737BS	½	10.2	-	¾-19	1	2.84	1.42	1.18	1.61(Hex)	1.06	72	M36x2	30	41(Hex)	27	0.82	370
WA3623737	½	10.2	¾-18	-	1	2.84	1.42	1.18	1.61(Hex)	1.06	72	M36x2	30	41(Hex)	27	0.82	372
WA3603700	½	10.2	-	½-14	1	2.95	1.42	1.18	1.61(Hex)	1.06	75	M36x2	30	41(Hex)	27	0.79	360
WA3623750	½	10.2	½-14	-	1	2.95	1.42	1.18	1.61(Hex)	1.06	75	M36x2	30	41(Hex)	27	0.80	361
WA3604750BS	¾	13	-	½-14	1	3.15	1.65	1.57	1.42	1.42	80	M42x2	40	36	36	1.06	480
WA3624750	¾	13	½-14	-	1	3.15	1.65	1.57	1.42	1.42	80	M42x2	40	36	36	1.07	484
WA3604700	¾	13	-	¾-14	1	3.15	1.65	1.57	1.42	1.42	80	M42x2	40	36	36	1.03	466
WA3624775	¾	13	¾-14	-	1	3.15	1.65	1.57	1.42	1.42	80	M42x2	40	36	36	1.04	472
WA3605775BS	1	16.9	-	¾-14	1	3.78	1.89	1.81	1.65	1.65	96	M48x3	46	42	42	1.62	735
WA3625775	1	16.9	¾-14	-	1	3.78	1.89	1.81	1.65	1.65	96	M48x3	46	42	42	1.63	741
WA3605700	1	16.9	-	1-11	1	3.78	1.89	1.81	1.65	1.65	96	M48x3	46	42	42	1.51	684
WA36257100	1	16.9	1-11½	-	1	3.78	1.89	1.81	1.65	1.65	96	M48x3	46	42	42	1.53	694
WA3606700	1¼	22.4	-	1¼-11	1	4.96	2.76	2.83	2.56	2.56	126	M70x3	72	65	65	4.82	2185
WA36267125	1¼	22.4	1¼-11½	-	1	4.96	2.76	2.83	2.56	2.56	126	M70x3	72	65	65	4.87	2207
WA36067150BS	1¼	22.4	-	1½-11	1	4.96	2.76	2.83	2.56	2.56	126	M70x3	72	65	65	4.63	2101
WA36267150	1¼	22.4	1½-11½	-	1	4.96	2.76	2.83	2.56	2.56	126	M70x3	72	65	65	4.68	2121

* Alternative end connections upon request.

To obtain connected length of coupling add dimensions A (Fig. 1) and K (Fig. 3) or O (Fig. 4) together.

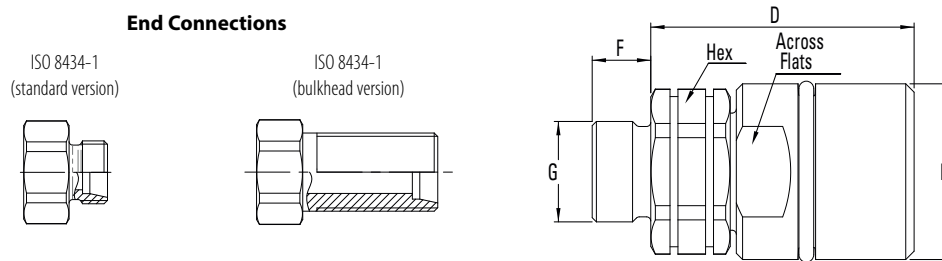

Figure 2

Sockets (Female) with External Thread

Part Number	Body Size	Nominal Flow Diameter	Thread Size* (Male)	Dimensions												Weight		
				NBR	(in)	(mm)	ISO 8434-1**	Fig.	D (in)	E (in)	F (in)	G (in)	Across Flats (in)	Hex (in)	D (mm)	E (mm)	F (mm)	G (mm)
WA3633708L			M14x1.5 - 8L	2	2.32	1.42	0.39	0.55	1.61(Hex)	1.06	59	M36x2	10	M14x1.5	41(Hex)	27	0.73	330
WA3633710L			M16x1.5 - 10L	2	2.28	1.42	0.43	0.63	1.61(Hex)	1.06	58	M36x2	11	M16x1.5	41(Hex)	27	0.72	328
WA3633712L	½	10.2	M18x1.5 - 12L	2	2.28	1.42	0.43	0.71	1.61(Hex)	1.06	58	M36x2	11	M18x1.5	41(Hex)	27	0.73	330
WA3633715L			M22x1.5 - 15L	2	2.24	1.42	0.47	0.87	1.61(Hex)	1.06	57	M36x2	12	M22x1.5	41(Hex)	27	0.77	350
WA3633715LBH			M22x1.5 - 15L Bulkhead	2	2.28	1.42	1.50	0.87	1.61(Hex)	1.06	58	M36x2	38	M22x1.5	41(Hex)	27	0.85	385

* Alternative end connections upon request.

** Light L series = working pressure 250 bar/3625 psi max.

To obtain connected length of coupling add dimensions D (Fig. 2) and K (Fig. 3) or O (Fig. 4) together.

W36000 Series

Thread-to-Connect

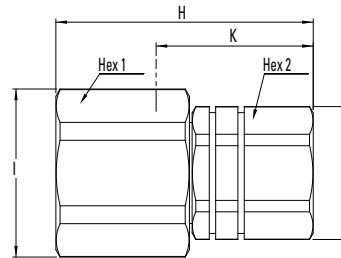

Figure 3

Plugs (Male) with Internal Thread

Part Number	Body Size (in)	Nominal Flow Diameter (mm)	Thread Size* (Female)			Dimensions											Weight		
			NPT	BSPP	Fig.	H (in)	I (in)	J (in)	K (in)	Hex 1 (in)	Hex 2 (in)	H (mm)	I (mm)	J (mm)	K (mm)	Hex 1 (mm)	Hex 2 (mm)	lbs	grams
WA3601400	¼	5.3	-	¼-19	3	2.17	1.26	0.94	1.22	1.14	0.87	55	32	24	31	29	22	0.41	184
WA3621425	¼	5.3	¼-18	-	3	2.17	1.26	0.94	1.22	1.14	0.87	55	32	24	31	29	22	0.33	150
WA3602425BS	¾	7.3	-	¼-19	3	2.28	1.38	0.94	1.26	1.26	0.87	58	35	24	32	32	22	0.36	164
WA3622425	¾	7.3	¼-18	-	3	2.28	1.38	0.94	1.26	1.26	0.87	58	35	24	32	32	22	0.37	166
WA3602400	¾	7.3	-	¾-19	3	2.28	1.38	0.94	1.26	1.26	0.87	58	35	24	32	32	22	0.35	158
WA3622437	¾	7.3	¾-18	-	3	2.28	1.38	0.94	1.26	1.26	0.87	58	35	24	32	32	22	0.35	160
WA3603437BS	½	10.2	-	¾-19	3	2.52	1.77	1.18	1.46	1.61	1.06	64	45	30	37	41	27	0.61	276
WA3623437	½	10.2	¾-18	-	3	2.52	1.77	1.18	1.46	1.61	1.06	64	45	30	37	41	27	0.61	278
WA3603400	½	10.2	-	½-14	3	2.60	1.77	1.18	1.57	1.61	1.06	66	45	30	40	41	27	0.60	271
WA3623450	½	10.2	½-14	-	3	2.60	1.77	1.18	1.57	1.61	1.06	66	45	30	40	41	27	0.60	273
WA3604450BS	¾	13.0	-	½-14	3	3.03	1.97	1.57	1.85	1.81	1.42	77	50	40	47	46	36	1.01	456
WA3624450	¾	13.0	½-14	-	3	3.03	1.97	1.57	1.85	1.81	1.42	77	50	40	47	46	36	1.01	460
WA3604400	¾	13.0	-	¾-14	3	3.03	1.97	1.57	1.85	1.81	1.42	77	50	40	47	46	36	0.97	442
WA3624475	¾	13.0	¾-14	-	3	3.03	1.97	1.57	1.85	1.81	1.42	77	50	40	47	46	36	0.99	448
WA3605475BS	1	16.9	-	¾-14	3	3.62	2.36	1.81	2.24	2.17	1.65	92	60	46	57	55	42	1.77	805
WA3625475	1	16.9	¾-14	-	3	3.62	2.36	1.81	2.24	2.17	1.65	92	60	46	57	55	42	1.79	811
WA3605400	1	16.9	-	1-11	3	3.62	2.36	1.81	2.24	2.17	1.65	92	60	46	57	55	42	1.66	751
WA36254100	1	16.9	1-11½	-	3	3.62	2.36	1.81	2.24	2.17	1.65	92	60	46	57	55	42	1.68	761
WA3606400	1¼	22.4	-	1¼-11	3	4.72	3.50	2.83	2.76	3.03	2.56	120	89	72	70	77	65	5.56	2520
WA36264125	1¼	22.4	1¼-11½	-	3	4.72	3.50	2.83	2.76	3.03	2.56	120	89	72	70	77	65	5.60	2542
WA36064150BS	1¼	22.4	-	1½-11	3	4.72	3.50	2.83	2.76	3.03	2.56	120	89	72	70	77	65	5.37	2436
WA36264150	1¼	22.4	1½-11½	-	3	4.72	3.50	2.83	2.76	3.03	2.56	120	89	72	70	77	65	5.41	2456

* Alternative end connections upon request.

To obtain connected length of coupling add dimensions K (Fig. 3) and A (Fig. 1) or D (Fig. 2) together.

End Connections

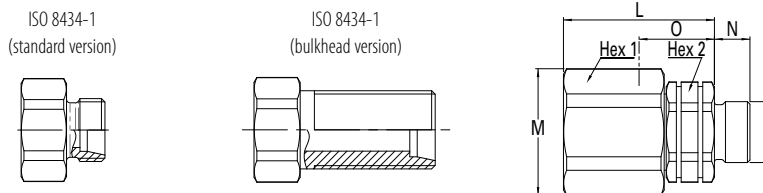

Figure 4

Plugs (Male) with External Thread

Part Number	Body Size (in)	Nominal Flow Diameter (mm)	Thread Size* (Male)	Fig.	Dimensions											Weight				
					L (in)	M (in)	N (in)	O (in)	P (in)	Hex 1 (in)	Hex 2 (in)	L (mm)	M (mm)	N (mm)	O (mm)	P (mm)	Hex 1 (mm)	Hex 2 (mm)	lbs	grams
WA3633408L			M14x1.5 - 8L	4	1.93	1.77	0.39	1.42	0.55	1.61	1.06	49	45	10	36	M14x1.5	41	27	0.56	255
WA3633410L			M16x1.5 - 10L	4	1.93	1.77	0.43	1.42	0.63	1.61	1.06	49	45	11	36	M16x1.5	41	27	0.56	253
WA3633412L	½	10.2	M18x1.5 - 12L	4	1.93	1.77	0.43	1.42	0.71	1.61	1.06	49	45	11	36	M18x1.5	41	27	0.56	255
WA3633415L			M22x1.5 - 15L	4	1.93	1.77	0.47	1.42	0.87	1.61	1.06	49	45	12	36	M22x1.5	41	27	0.61	275
WA3633415LBH			M22x1.5 - 15L Bulkhead	4	1.93	1.77	1.50	1.42	0.87	1.61	1.06	49	45	38	36	M22x1.5	41	27	0.68	310

* Alternative end connections upon request.

** Light L series = working pressure 250 bar/3625 psi max.

To obtain connected length of coupling add dimensions O (Fig. 4) and A (Fig. 1) or D (Fig. 2) together.

W36000 Series

Thread-to-Connect

Dust Plugs and Dust Caps

Body Size (in)	Socket Dust Plug Part Number		Plug Dust Cap Part Number	
	Anodized Aluminum	PVC	Anodized Aluminum	PVC
¼	WD3611700	WP3611700	WD3611400	WP3611400
⅜	WD3612700	WP3612700	WD3612400	WP3612400
½	WD3613700	WP3613700	WD3613400	WP3613400
¾	WD3614700	WP3614700	WD3614400	WP3614400
1	WD3615700	WP3615700	WD3615400	WP3615400
1¼	WD3616700	WP3616700	WD3616400	WP3616400

For installation instructions, please contact your Danfoss sales representative



Metal Socket Dust Plug



Metal Plug Dust Cap



PVC Socket Dust Plug



PVC Plug Dust Cap

Seal Kit for Servicing Sockets (Female)

Body Size (in)	Seal & Back-up Ring Kit*	NBR seals & PTFE back-up rings
	Part Number	
¼	WG3601700	10 seals + 10 back-up rings
⅜	WG3602700	10 seals + 10 back-up rings
½	WG3603700	10 seals + 10 back-up rings
¾	WG3604700	5 seals + 5 back-up rings
1	WG3605700	5 seals + 5 back-up rings
1½	WG3606700	1 seal + 1 back-up ring

*The valve seal is not included in our repair kits

GA90090 Series

Fluid transfer & Hydraulic application



Danfoss' high pressure hydraulic coupling GA90090 was engineered to perform in applications that require the highest level of performance. Working pressure of up to 420 bar (6,000psi) in all sizes. One of the most demanding applications is the drill hammer used in construction.

Product Features

- Maximum working pressure up to 420 bar [6000 psi] in all sizes
- Available in size 8, 12, and 16
- Available thread configurations: Metric, UN, and BSP
- Unique profile: not interchangeable
- Self-sealing features guarantee minimum air inclusion and loss of fluid
- Connection via adapter
- Detachable under pressure
- Long lifetime in dynamic applications
- Works in applications where higher pressures are needed
- Exceeds the requirements of ISC7241/1
- Standard model available in Zinc plated steel

Physical Characteristics

Body Size	Nominal Flow Diameter	Max. Working Pressure		Rated Flow*	
Dash size	(mm)	(bar)	(psi)	(lpm)	(gpm)
-8	9,81	400	5800	40	10,56
-12	16,75	330	4700	150	39,62
-16	21,18	330	4700	200	52,83

*Indicated values refer to a 1 bar/14,5 psi pressure drop.

Applications & Markets

- High-pressure hydraulic systems and fluid transfer used in the construction, agriculture and forestry markets
- Dynamic hydraulic applications like the drilling hammer

Flow Data

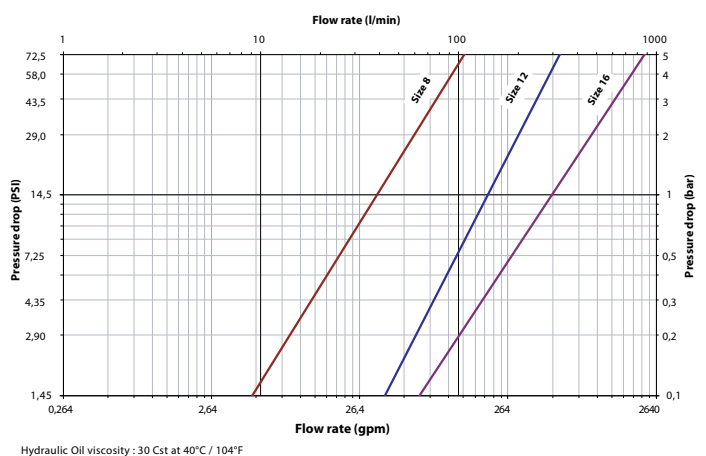

GA90090 Series

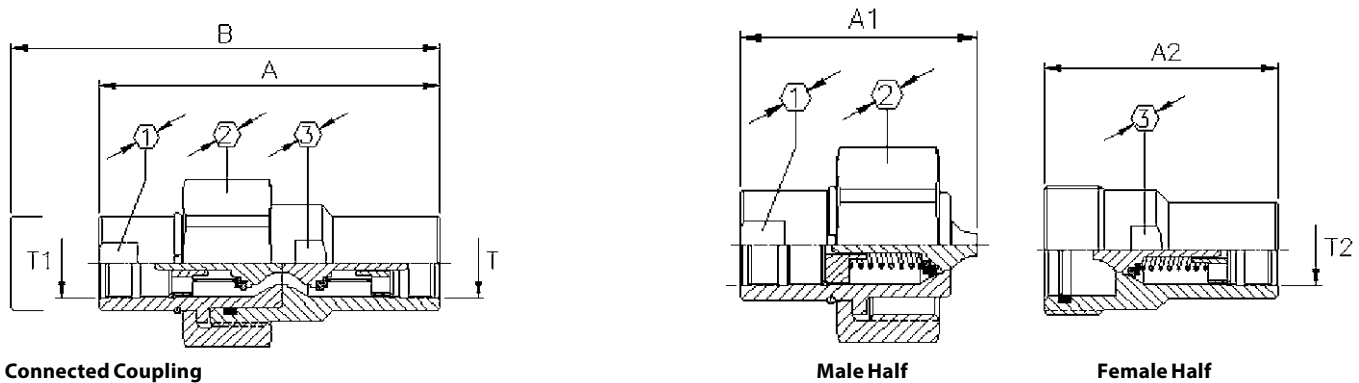

Connected Coupling

Male Half

Female Half

Metric Thread

Size	DN	Coupling	Thread	A	B	Hex 1	Hex 2	Hex 3
				(mm)	(mm)	(mm)	(mm)	(mm)
-8	12	GA90090-8	M22x1,5	89.1	105	27	41	27
-12	16	GA90090-12	M30x1,5	143.6	183	36	65	46
-16	20	GA90090-16	M38x1,5	163.7	196.7	50	75	55

Size	DN	Male Half	Female Half	A1	A2
				(mm)	(mm)
-8	12	GA90092-8	GA90091-8	45.7	59.4
-12	16	GA90092-12	GA90091-12	76.8	96.7
-16	20	GA90092-16	GA90091-16	81.7	115.0

UNF-Thread*

Size	DN	Coupling	Thread	A	B	Hex 1	Hex 2	Hex 3
				(mm)	(mm)	(mm)	(mm)	(mm)
-8	12	GA90762-8	7/8-14UNF-2B	93.1	109	27	41	27
-12	16	GA90762-12	1 3/8-12UNF-2B	163.7	196.7	36	65	46

Size	DN	Male Half	Female Half	A1	A2
				(mm)	(mm)
-8	12	GA90764-8	GA90763-8	47.7	61.4
-12	16	GA90764-12	GA90763-12	88.8	106.7

*Thread according to SAE J1926-1 (ISO 11926-1)

BSP-Thread

Size	DN	Coupling	Thread	A	B	Hex 1	Hex 2	Hex 3
				(mm)	(mm)	(mm)	(mm)	(mm)
-8	12	GA90769-8	G 1/2"-14	99.1	115	27	41	27
-12	16	GA90769-12-16	G 1"-11	158.8	188.7	36	65	46
-16	20	GA90769-16-20	G 1 1/4"-11	163.7	196.7	50	75	55

Size	DN	Male Half	Female Half	A1	A2
				(mm)	(mm)
-8	12	GA90769-8	GA90768-8	50.7	64.4
-12	16	GA90769-12-16	GA90768-12-16	84.4	104.3
-16	20	GA90769-16-20	GA90768-16-20	81.7	115.0

Dust plugs and caps

Body Size	Plug Dust Plug Part Number	Socket Dust Cap Part Number
Dash size	Aluminium	Aluminium
-8	GA17006-8	GA17005-8
-12	GA17006-12	GA17005-12
-16	GA17006-16	GA17005-16

IP Series

Fluid transfer & Hydraulic application



Danfoss Hansen IP Series steel quick disconnect coupling is a screw-to-connect coupling for Subsea Oil & Gas applications. Due to the rugged construction of its unique design and special 1.4404 stainless steel material the coupling can withstand highest operating pressures up to 1379 bar and is suited for most corrosive environment in subsea.

Product Features

- Standard body material: 316L / 1.4404 stainless steel corrosion resistant
- Standard seal material: HNBR, NBR on the valve
- Thread-to-connect with double shut-off valving
- Proprietary profile
- Can be connected under residual pressure
- Working temperature : -32°C / +150°C
- Optional dust caps and plugs (made of stainless steel)

Application

- Hydraulic, Testing of Wellheads in subsea Oil & Gas

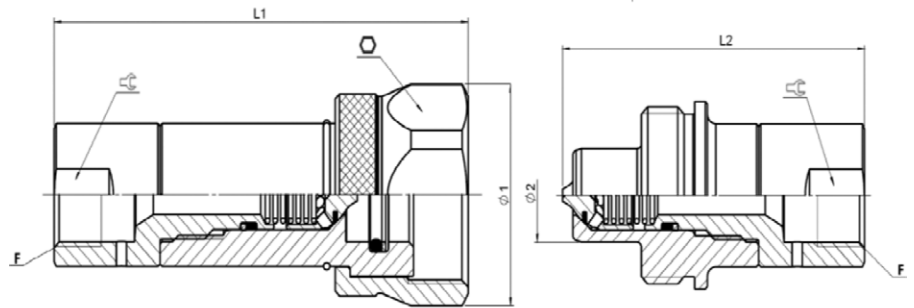

Physical characteristics

Body Size	Working Pressure		Nominal Flow Diameter (mm)	Plug part number	Socket part number	Thread Size (Female)	Tube size (in)	Socket dimensions				Plug dimensions			Length connected (mm)
	(bar)	(psi)						L1 (mm)	Ø 1 (mm)	Ø 2 (mm)	Ø 3 (mm)	L2 (mm)	Ø 2 (mm)	Ø 3 (mm)	
1/4"	1,379	20,000	2.8	2IPP25MP	2IPS25MP	7/16-20 UNF -2B	1/4"	82	38	35	23	58	32	23	112
1/4"	1,379	20,000	5.2	2IPP37MP	2IPS37MP	9/16-18 UNF -2B	3/8"	82	38	35	23	58	32	23	112
3/8"	1,034	15,000	8,1	3IPP56MP	3IPS56MP	13/16-16 UN -2B	9/16"	96	45	41	27	71	38	27	138
1/2"	965	14,000	11,1	4IPP75MP	4IPS75MP	3/4-14 NPSM -2B	3/4"	109	55	50	35	81.4	50	35	154,1
3/4"	689	10,000	16,5	6IPP100MP	6IPS100MP	1 3/8-12 UNF -2B	1"	139.8	63	58	41	105.2	60	41	200,5

Dust Plugs and Dust Caps

Body Size (in)	Waterproof dust cap for female	Waterproof dust cap for male
	Stainless Steel	Stainless Steel
1/4"	SDC2IP	XPDC2IP
3/8"	SDC3IP	XPDC3IP
1/2"	SDC4IP	XPDC4IP
3/4"	SDC6IP	XPDC6IP

Flow Data

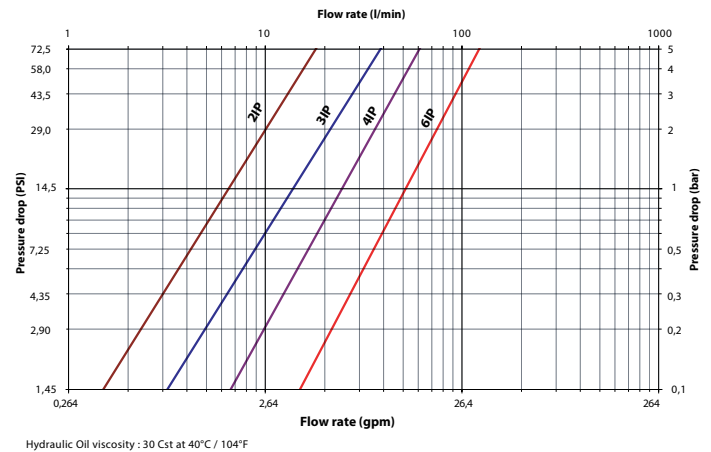

W6000 Series (Steel) Thread-to-Connect

Fluid transfer & Hydraulic application



Danfoss Hansen W6000 Series steel quick disconnect coupling is a thread-to-connect with a rugged construction. It remains the series users refer to when it deals with severe hydraulic applications, such as construction and mining. The design and materials used give this quick disconnect coupling resistance to heavy mechanical loads. Most common examples are ram loads, hydraulic shocks and severe pulsating pressures.

Product Features

- Proprietary profile
- Thread-to-connect with double shut-off valving
- Optional dust caps and plugs (made of anodized aluminum)
- Can be connected under residual pressure up to 30 bar with standard seal, up to 150 bar with PU seal
- Standard body material: Zinc trivalent plated steel
- Standard seal material: NBR, FKM, EPDM

European Pressure Equipment Directive

Couplings with nominal diameters up to and including 25 mm are designed and manufactured under Article 4.3 of the European Pressure Equipment Directive PED 2014/68/EU. Couplings with nominal diameters greater than 25 mm are designed and manufactured in accordance with the stipulations of Module A of the European Pressure Equipment Directive PED 2014/68/EU. They should not be used to convey unstable gases.

Group 1 = Hazardous media / Group 2 = Other media

Physical Characteristics

Body Size	Nominal Flow Diameter	Max. Operating Pressure*				Maximum Residual Pressure during Connection***		Rated Flow**		Fluid Loss
		Non hazardous liquids & gases in Group 2		Hazardous liquids & gases in Group 1		(bar)	(psi)	(lpm)	(gpm)	
(in)	(mm)	(bar)	(psi)	(bar)	(psi)	(bar)	(psi)	(lpm)	(gpm)	ml-cc.
¼	5.7	1,100	15,950	1,100	15,950	30	435	11.6	3.06	1.1
⅜	7.6	750	10,875	750	10,875	30	435	16.7	4.41	1.9
½	10.3	750	10,875	750	10,875	30	435	25.5	6.74	2.8
¾	14.2	650	9,425	650	9,425	50	725	55	14.53	5.8
1	16.5	450	6,525	450	6,525	30	435	87	22.98	10.9
1¼	20.5	450	6,525	450	6,525	30	435	140	36.98	26.9
1½	25.8	300	4,350	38	550	30	435	208	54.95	37.5
2	34.7	300	4,350	28	405	30	435	357	94.30	81

* For pulsating pressures when disconnected apply a multiplier of 0.5

** Indicated values refer to a 1 bar/14.5 psi pressure drop.

*** When connecting under pressure, the socket nut thread must be lubricated.

Applications & Markets

- Construction
- Oil & Gas
- Material Handling
- All industrial and severe applications
- Systems subject to heavy mechanical loads, high pressures

Flow Data

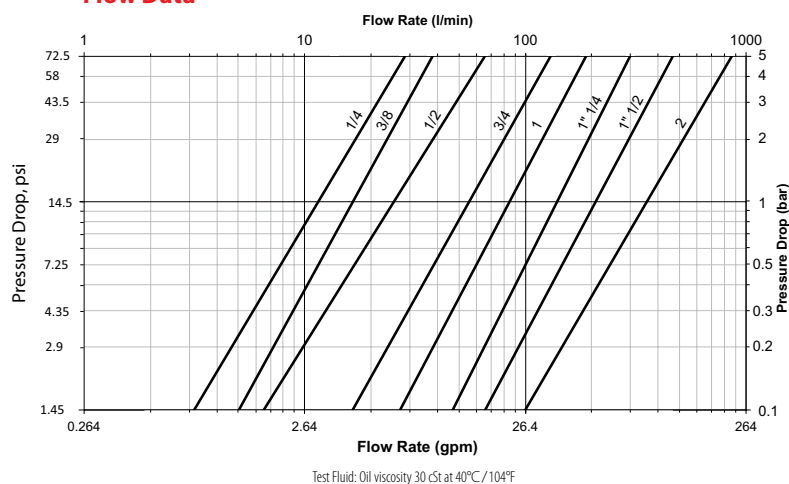

Seal Elastomer Data*

Seal Elastomer	Max. Operation Temperature Range
NBR (Nitrile)	-20°C +100°C/-4°F +212°F
FKM	-20°C +200°C/-4°F +392°F
EPDM (Ethylene-Propylene)	-40°C +150°C/-40°F +302°F

* For reference only, based on Danfoss recommended temperatures.

Contact Danfoss technical support for further information on fluid compatibility.

W6000 Series (Steel)

Thread-to-Connect

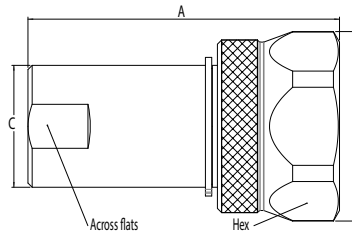

Figure 1

Sockets (Female)

Part Number			Body Size (in)	Nominal Flow Diameter (mm)	Thread Size* (Female)			Dimensions										Weight		
NBR	FKM	EPDM			NPT	BSPP	Metric	Fig.	A (in)	B (in)	C (in)	Across Flats (in)	Hex (in)	A (mm)	B (mm)	C (mm)	Across Flats (mm)	Hex (mm)	lbs	grams
WA0601700	WA06017V0	WA06017E0	¼	5.7	-	¼-19	-	1	2.09	1.38	0.83	0.75	1.26	53	35	21	19	32	0.32	144
WA0621700	WA06217V0	WA06217E0	¼	5.7	¼-18	-	-	1	2.09	1.38	0.83	0.75	1.26	53	35	21	19	32	0.32	144
WA0602700	WA06027V0	WA06027E0	⅜	7.6	-	⅜-19	-	1	2.56	1.50	0.98	0.90	1.38	65	38	25	23	35	0.48	217
WA0622700	WA06227V0	WA06227E0	⅜	7.6	⅜-18	-	-	1	2.56	1.50	0.98	0.90	1.38	65	38	25	23	35	0.48	217
WA0603700	WA06037V0	WA06037E0	½	10.3	-	½-14	-	1	2.91	1.77	1.14	1.06	1.61	74	45	29	27	41	0.71	320
WA0623700	WA06237V0	WA06237E0	½	10.3	½-14	-	-	1	2.91	1.77	1.14	1.06	1.61	74	45	29	27	41	0.71	320
WA0633700	WA06337V0	WA06337E0	½	10.3	-	-	M22x1.5	1	2.91	1.77	1.14	1.06	1.61	74	45	29	27	41	0.71	320
WA0604700	WA06047V0	WA06047E0	¾	14.2	-	¾-14	-	1	3.58	2.16	1.50	1.38	1.97	91	55	38	35	50	1.32	600
WA0624700	WA06247V0	WA06247E0	¾	14.2	¾-14	-	-	1	3.58	2.16	1.50	1.38	1.97	91	55	38	35	50	1.32	600
WA0605700	WA06057V0	WA06057E0	1	16.5	-	1-11	-	1	4.05	2.72	1.81	1.61	2.56	103	69	46	41	65	2.41	1092
WA0625700	WA06257V0	WA06257E0	1	16.5	1-11½	-	-	1	4.05	2.72	1.81	1.61	2.56	103	69	46	41	65	2.41	1092
WA0635700	WA06357V0	WA06357E0	1	16.5	-	-	M33x1.5	1	4.05	2.72	1.81	1.61	2.56	103	69	46	41	65	2.41	1092
WA0606700	WA06067V0	WA06067E0	1¼	20.5	-	1¼-11	-	1	5.71	3.50	2.36	2.16	3.03	145	89	60	55	77	6.13	2780
WA0626700	WA06267V0	WA06267E0	1¼	20.5	1¼-11½	-	-	1	5.71	3.50	2.36	2.16	3.03	145	89	60	55	77	6.13	2780
WA0607700	WA06077V0	WA06077E0	1½	25.8	-	1½-11	-	1	6.81	3.94	2.64	2.48	3.46	173	100	67	63	88	9.26	4200
WA0627700	WA06277V0	WA06277E0	1½	25.8	1½-11½	-	-	1	6.81	3.94	2.64	2.48	3.46	173	100	67	63	88	9.26	4200
WA0609700	WA06097V0	WA06097E0	2	34.7	-	2-11	-	1	8.07	4.60	3.07	2.80	4.13	205	117	78	71	105	14.64	6640
WA0629700	WA06297V0	WA06297E0	2	34.7	2-11½	-	-	1	8.07	4.60	3.07	2.80	4.13	205	117	78	71	105	14.64	6640

* Alternative end connections available upon request.

To obtain connected length of coupling add dimensions A (Fig.1) and G (Fig. 2) together.

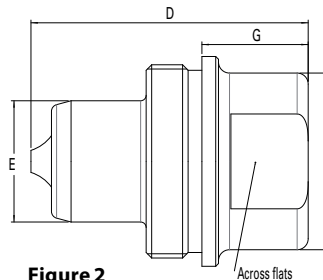

Figure 2

Plugs (Male)

Part Number			Body Size (in)	Nominal Flow Diameter (mm)	Thread Size* (Female)			Dimensions										Weight		
NBR	FKM	EPDM			NPT	BSPP	Metric	Fig.	D (in)	E (in)	F (in)	G (in)	Across Flats (in)	D (mm)	E (mm)	F (mm)	G (mm)	Across Flats (mm)	lbs	grams
WA0601400	WA06014V0	WA06014E0	¼	5.7	-	¼-19	-	2	1.38	0.59	0.90	0.45	0.75	35	15	23	11.5	19	0.16	71
WA0621400	WA06214V0	WA06214E0	¼	5.7	¼-18	-	-	2	1.38	0.59	0.90	0.45	0.75	35	15	23	11.5	19	0.16	71
WA0602400	WA06024V0	WA06024E0	⅜	7.6	-	⅜-19	-	2	1.65	0.75	1.02	0.52	0.90	42	19	26	13	23	0.23	104
WA0622400	WA06224V0	WA06224E0	⅜	7.6	⅜-18	-	-	2	1.65	0.75	1.02	0.52	0.90	42	19	26	13	23	0.23	104
WA0603400	WA06034V0	WA06034E0	½	10.3	-	½-14	-	2	1.97	0.87	1.26	0.77	1.06	50	22	32	19.5	27	0.36	165
WA0623400	WA06234V0	WA06234E0	½	10.3	½-14	-	-	2	1.97	0.87	1.26	0.77	1.06	50	22	32	19.5	27	0.36	165
WA0633400	WA06334V0	WA06334E0	½	10.3	-	-	M22x1.5	2	1.97	0.87	1.26	0.77	1.06	50	22	32	19.5	27	0.36	165
WA0604400	WA06044V0	WA06044E0	¾	14.2	-	¾-14	-	2	2.48	1.14	1.65	1.02	1.38	63	29	42	26	35	0.84	382
WA0624400	WA06244V0	WA06244E0	¾	14.2	¾-14	-	-	2	2.48	1.14	1.65	1.02	1.38	63	29	42	26	35	0.84	382
WA0605400	WA06054V0	WA06054E0	1	16.5	-	1-11	-	2	2.80	1.42	1.89	1.14	1.61	71	36	48	29	41	1.29	585
WA0625400	WA06254V0	WA06254E0	1	16.5	1-11½	-	-	2	2.80	1.42	1.89	1.14	1.61	71	36	48	29	41	1.29	585
WA0635400	WA06354V0	WA06354E0	1	16.5	-	-	M33x1.5	2	2.80	1.42	1.89	1.14	1.61	71	36	48	29	41	1.29	585
WA0606400	WA06064V0	WA06064E0	1¼	20.5	-	1¼-11	-	2	3.82	2.00	2.36	1.45	2.16	97	50.9	60	37	55	3.22	1460
WA0626400	WA06264V0	WA06264E0	1¼	20.5	1¼-11½	-	-	2	3.82	2.00	2.36	1.45	2.16	97	50.9	60	37	55	3.22	1460
WA0607400	WA06074V0	WA06074E0	1½	25.8	-	1½-11	-	2	4.29	2.24	2.64	1.22	2.48	109	56.9	67	31	63	4.50	2040
WA0627400	WA06274V0	WA06274E0	1½	25.8	1½-11½	-	-	2	4.29	2.24	2.64	1.22	2.48	109	56.9	67	31	63	4.50	2040
WA0609400	WA06094V0	WA06094E0	2	34.7	-	2-11	-	2	5.08	2.73	3.07	1.32	2.80	129	69.4	78	33	71	7.05	3200
WA0629400	WA06294V0	WA06294E0	2	34.7	2-11½	-	-	2	5.08	2.73	3.07	1.32	2.80	129	69.4	78	33	71	7.05	3200

* Alternative end connections available upon request.

To obtain connected length of coupling add dimensions A (Fig.1) and G (Fig. 2) together.

W6000 Series (Steel)

Thread-to-Connect

Dust Plugs and Dust Caps

Body Size	Socket Dust Plug Part Number	Plug Dust Cap Part Number
(in)	Anodized Aluminum	Anodized Aluminum
¼	WD0611700	WD0611400
⅜	WD0612700	WD0612400
½	WD0613700	WD0613400
¾	WD0614700	WD0614400
1	WD0615700	WD0615400
1¼	WD0616700	WD0616400
1½	WD0617700	WD0617400
2	WD0619700	WD0619400

Seal kit for servicing sockets (Female)

Body Size	Seal & Back-up Ring Kit*		Qty
(in)	NBR seals & PTFE back-up rings	FKM seals & PTFE back-up rings	
¼	WG0601700	WG06017V0	50 O-rings + 50 Backup rings
⅜	WG0602700	WG06027V0	50 O-rings + 50 Backup rings
½	WG0603700	WG06037V0	50 O-rings + 50 Backup rings
¾	WG0604700	WG06047V0	50 O-rings + 50 Backup rings
1	WG0605700	WG06057V0	50 O-rings + 50 Backup rings
1¼	WG0606700	WG06067V0	15 O-rings + 15 Backup rings
1½	WG0607700	WG06077V0	15 O-rings + 15 Backup rings
2	WG0609700	WG06097V0	15 O-rings + 15 Backup rings

*The valve seal is not included in our repair kits

EPDM seals (-40°C/+150°C) are also available but kit part number doesn't exist. Please ask our technical support in case you need this compound.

W6000 Series (Stainless Steel) Thread-to-Connect

Fluid transfer & Hydraulic application



Danfoss Hansen W6000 Series stainless steel quick disconnect coupling is a thread-to-connect with a rugged construction. This quick disconnect coupling utilizes 1.4418 grade stainless steel, which guarantees the same mechanical resistance as the steel version while offering excellent resistance in corrosive environments. It remains the coupling of choice in offshore oil & gas applications but also covers a wide range of alternative hydraulic applications.

Product Features

- Proprietary profile
- Thread-to-connect with double shut-off valving
- Resistance to heavy mechanical loads (hydraulic shocks, severe pulsating pressures, etc.).
- Optional dust caps and plugs (made of anodized aluminum)
- Can be connected under residual pressure
- Standard seal material: FKM, EPDM
- Standard body material: Stainless steel 1.4418 (1.4404 AISI 316L stainless steel available on request at lower operating pressures). Please contact Danfoss technical support for further information

European Pressure Equipment Directive

Couplings with nominal diameters up to and including 25 mm are designed and manufactured under Article 4.3 of the European Pressure Equipment Directive PED 2014/68/EU. Couplings with nominal diameters greater than 25 mm are designed and manufactured in accordance with the stipulations of Module A of the European Pressure Equipment Directive PED 2014/68/EU. They should not be used to convey unstable gases.

Group 1 = Hazardous media /
Group 2 = Other media

Applications & Markets

- Construction
- Oil & Gas
- Material Handling
- All industrial and severe applications
- Systems subject to heavy mechanical loads, high pressures

Physical Characteristics

Max. Operating Pressure*										
Body Size (in)	Nominal Flow Diameter (mm)	Non hazardous liquids & gases Group 2		Hazardous liquids & gases Group 1		Maximum Residual Pressure during Connection***		Rated Flow**		Fluid Loss ml-cc.
		(bar)	(psi)	(bar)	(psi)	(bar)	(psi)	(lpm)	(gpm)	
¼	5.7	1100	15,950	1100	15,950	30	435	11.6	3.06	1.1
⅜	7.6	750	10,875	750	10,875	30	435	16.7	4.41	1.9
½	10.3	750	10,875	750	10,875	30	435	25.5	6.74	2.8
¾	14.2	650	9,425	650	9,425	50	725	55	14.53	5.8
1	16.5	450	6,525	450	6,525	30	435	87	22.98	10.9
1¼	20.5	450	6,525	450	6,525	30	435	140	36.98	26.9
1½	25.8	300	4,350	38	550	30	435	208	54.95	37.5
2	34.7	300	4,350	28	405	30	435	357	94.30	81.0

* For pulsating pressures when disconnected apply a multiplier of 0.5

** Indicated values refer to a 1 bar/14.5 psi pressure drop.

*** When connecting under pressure, the socket nut thread must be lubricated.

Flow Data

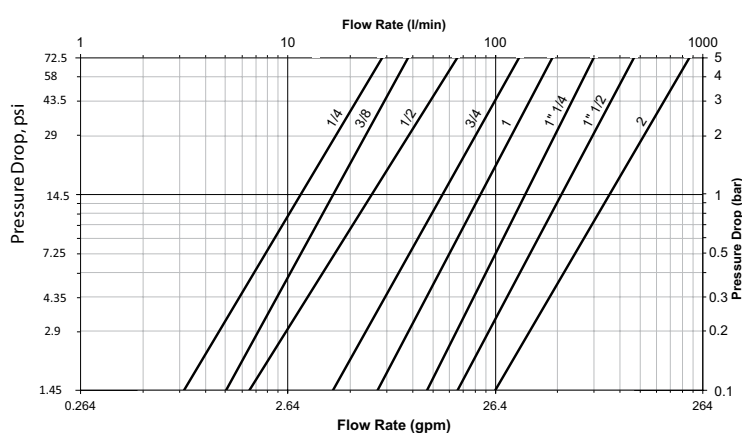

Test Fluid: Oil viscosity 30 cSt at 40°C / 104°F

Seal Elastomer Data*	
Seal Elastomer	Max. Operation Temperature Range
FKM	-20°C +200°C / -4°F +392°F
EPDM (Ethylene-Propylene)	-40°C +150°C / -40°F +302°F

* For reference only, based on Danfoss recommended temperatures.

Contact Danfoss technical support for further information on fluid compatibility.

W6000 Series (Stainless Steel)

Thread-to-Connect

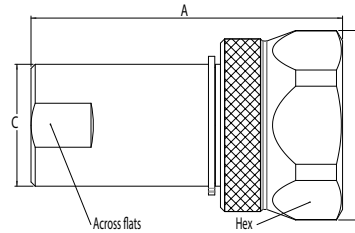

Figure 1

Sockets (Female)

Part Number*		Body Size	Nominal Flow Diameter	Thread Size** (Female)		Dimensions										Weight		
FKM	EPDM	(in)	(mm)	NPT	BSPP	Fig.	A (in)	B (in)	C (in)	Across Flats (in)	Hex (in)	A (mm)	B (mm)	C (mm)	Across Flats (mm)	Hex (mm)	lbs	grams
WV06017V0	WV06017E0	¼	5.7	-	¼-19	1	2.09	1.38	0.83	0.75	1.26	53	35	21	19	32	0.32	144
WV06217V0	WV06217E0	¼	5.7	¼-18	-	1	2.09	1.38	0.83	0.75	1.26	53	35	21	19	32	0.32	144
WV06027V0	WV06027E0	¾	7.6	-	¾-19	1	2.56	1.50	0.98	0.90	1.38	65	38	25	23	35	0.48	217
WV06227V0	WV06227E0	¾	7.6	¾-18	-	1	2.56	1.50	0.98	0.90	1.38	65	38	25	23	35	0.48	217
WV06037V0	WV06037E0	½	10.3	-	½-14	1	2.91	1.77	1.14	1.06	1.61	74	45	29	27	41	0.71	320
WV06237V0	WV06237E0	½	10.3	½-14	-	1	2.91	1.77	1.14	1.06	1.61	74	45	29	27	41	0.71	320
WV06047V0	WV06047E0	¾	14.2	-	¾-14	1	3.58	2.16	1.50	1.38	1.97	91	55	38	35	50	1.32	600
WV06247V0	WV06247E0	¾	14.2	¾-14	-	1	3.58	2.16	1.50	1.38	1.97	91	55	38	35	50	1.32	600
WV06057V0	WV06057E0	1	16.5	-	1-11	1	4.05	2.72	1.81	1.61	2.56	103	69	46	41	65	2.41	1092
WV06257V0	WV06257E0	1	16.5	1-11½	-	1	4.05	2.72	1.81	1.61	2.56	103	69	46	41	65	2.41	1092
WV06067V0	WV06067E0	1¼	20.5	-	1¼-11	1	5.71	3.50	2.36	2.16	3.03	145	89	60	55	77	6.13	2780
WV06267V0	WV06267E0	1¼	20.5	1¼-11½	-	1	5.71	3.50	2.36	2.16	3.03	145	89	60	55	77	6.13	2780
WV06077V0	WV06077E0	1½	25.8	-	1½-11	1	6.81	3.94	2.64	2.48	3.46	173	100	67	63	88	9.26	4200
WV06277V0	WV06277E0	1½	25.8	1½-11½	-	1	6.81	3.94	2.64	2.48	3.46	173	100	67	63	88	9.26	4200
WV06097V0	WV06097E0	2	34.7	-	2-11	1	8.07	4.60	3.07	2.80	4.13	205	117	78	71	105	14.64	6640
WV06297V0	WV06297E0	2	34.7	2-11½	-	1	8.07	4.60	3.07	2.80	4.13	205	117	78	71	105	14.64	6640

* 1.4404 AISI 316L stainless steel available on request. Please contact Danfoss technical support for further information.

** Alternative end connections available upon request.

To obtain connected length of coupling add dimensions A (Fig.1) and G (Fig. 2) together.

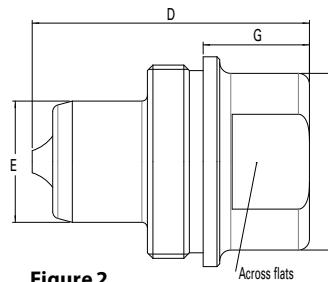

Figure 2

Plugs (Male)

Part Number*		Body Size	Nominal Flow Diameter	Thread Size** (Female)		Dimensions										Weight		
FKM	EPDM	(in)	(mm)	NPT	BSPP	Fig.	D (in)	E (in)	F (in)	G (in)	Across Flats (in)	D (mm)	E (mm)	F (mm)	G (mm)	Across Flats (mm)	lbs	grams
WV06014V0	WV06014E0	¼	5.7	-	¼-19	2	1.38	0.59	0.90	0.45	0.75	35	15	23	11.5	19	0.16	71
WV06214V0	WV06214E0	¼	5.7	¼-18	-	2	1.38	0.59	0.90	0.45	0.75	35	15	23	11.5	19	0.16	71
WV06024V0	WV06024E0	¾	7.6	-	¾-19	2	1.65	0.75	1.02	0.52	0.90	42	19	26	13	23	0.23	104
WV06224V0	WV06224E0	¾	7.6	¾-18	-	2	1.65	0.75	1.02	0.52	0.90	42	19	26	13	23	0.23	104
WV06034V0	WV06034E0	½	10.3	-	½-14	2	1.97	0.87	1.26	0.77	1.06	50	22	32	19.5	27	0.36	165
WV06234V0	WV06234E0	½	10.3	½-14	-	2	1.97	0.87	1.26	0.77	1.06	50	22	32	19.5	27	0.36	165
WV06044V0	WV06044E0	¾	14.2	-	¾-14	2	2.48	1.14	1.65	1.02	1.38	63	29	42	26	35	0.84	382
WV06244V0	WV06244E0	¾	14.2	¾-14	-	2	2.48	1.14	1.65	1.02	1.38	63	29	42	26	35	0.84	382
WV06054V0	WV06054E0	1	16.5	-	1-11	2	2.80	1.42	1.89	1.14	1.61	71	36	48	29	41	1.29	585
WV06254V0	WV06254E0	1	16.5	1-11½	-	2	2.80	1.42	1.89	1.14	1.61	71	36	48	29	41	1.29	585
WV06064V0	WV06064E0	1¼	20.5	-	1¼-11	2	3.82	2.00	2.36	1.45	2.16	97	50.9	60	37	55	3.22	1460
WV06264V0	WV06264E0	1¼	20.5	1¼-11½	-	2	3.82	2.00	2.36	1.45	2.16	97	50.9	60	37	55	3.22	1460
WV06074V0	WV06074E0	1½	25.8	-	1½-11	2	4.29	2.24	2.64	1.22	2.48	109	56.9	67	31	63	4.50	2040
WV06274V0	WV06274E0	1½	25.8	1½-11½	-	2	4.29	2.24	2.64	1.22	2.48	109	56.9	67	31	63	4.50	2040
WV06094V0	WV06094E0	2	34.7	-	2-11	2	5.08	2.73	3.07	1.32	2.80	129	69.4	78	33.5	71	7.05	3200
WV06294V0	WV06294E0	2	34.7	2-11½	-	2	5.08	2.73	3.07	1.32	2.80	129	69.4	78	33.5	71	7.05	3200

* 1.4404 AISI 316L stainless steel available on request. Please contact Danfoss technical support for further information.

** Alternative end connections available upon request.

To obtain connected length of coupling add dimensions A (Fig.1) and G (Fig. 2) together.

W6000 Series (Stainless Steel)

Thread-to-Connect

Dust Plugs and Dust Caps

Body Size	Socket Dust Plug Part Number	Plug Dust Cap Part Number
(in)	Anodized Aluminum	Anodized Aluminum
¼	WD0611700	WD0611400
⅜	WD0612700	WD0612400
½	WD0613700	WD0613400
¾	WD0614700	WD0614400
1	WD0615700	WD0615400
1¼	WD0616700	WD0616400
1½	WD0617700	WD0617400
2	WD0619700	WD0619400

Seal kit for servicing sockets (Female)

Body Size	Seal & Back-up Ring Kit*		Qty
(in)	NBR seals & PTFE back-up rings	FKM seals & PTFE back-up rings	
1/4	WG0601700	WG06017V0	50 O-rings + 50 Backup rings
3/8	WG0602700	WG06027V0	50 O-rings + 50 Backup rings
1/2	WG0603700	WG06037V0	50 O-rings + 50 Backup rings
3/4	WG0604700	WG06047V0	50 O-rings + 50 Backup rings
1	WG0605700	WG06057V0	50 O-rings + 50 Backup rings
1 1/4	WG0606700	WG06067V0	15 O-rings + 15 Backup rings
1 1/2	WG0607700	WG06077V0	15 O-rings + 15 Backup rings
2	WG0609700	WG06097V0	15 O-rings + 15 Backup rings

*The valve seal is not included in our repair kits

EPDM seals (-40°C/+150°C) are also available but kit part number doesn't exist. Please ask our technical support in case you need this compound.

5100 Series Thread to Connect

Fluid transfer & Hydraulic application



Danfoss Hansen 5100 Series brass coupling with steel tubular valve offers minimum air inclusion and fluid loss. Thread together latch provides connect under pressure capability and vibration resistance. The 5100 Series is not rated for continuous hydraulic impulse applications. For hydraulic impulse applications, refer to the FD86 and FD96 Series thread to connect product lines.

Product Features

- Tubular valve construction for virtually no fluid loss during disconnection, reduces environmental and worker safety hazards
- Low air inclusion during connection maintains system performance
- Available with wing or hex nut configurations
- Connect against pressure capability allows connecting of halves even when pressurized up to 500 psi
- Steel flange available for accessible bulkhead mounting
- Standard seal material: Nitrile (NBR)
- Standard body material: Brass body with high resistance carbon steel with zinc trivalent plated valving components, hex and wing nuts

Physical Characteristics

Body Dash Size	Body Interface Size	Max. Operating Pressure Connected		Max. Operating Pressure Disconnected									
		(bar)	(psi)	Plug/Male Half S2 and S4		Socket/Female Half S5		Vacuum	Rated Flow		Air Inclusion	Fluid Loss	
(in)	(in)	(bar)	(psi)	(bar)	(psi)	(bar)	(psi)	(in./Hg)	(lpm)	(gpm)	cc. max.	cc.max.	
¼	¼	207	3,000	207	3,000	207	3,000	28	15	4	.03	.01	
⅜	½	207	3,000	207	3,000	207	3,000	28	26	7	.05	.06	
½	½	207	3,000	207	3,000	207	3,000	28	26	7	.05	.10	
⅝	¾	207	3,000	207	3,000	207	3,000	28	68	18	.14	.10	
¾	¾	207	3,000	207	3,000	207	3,000	28	68	18	.34	.26	
1	1	207	3,000	207	3,000	207	3,000	28	151	40	.50	.35	
1¼	1¼	190	2,750	172	2,500	190	2,750	28	284	75	.68	.70	
1½	1½	172	2,500	172	2,500	138	2,000	28	379	100	.60	.94	

Applications & Markets

- Hydraulics and Fluid Transfer
- On-highway Hydraulic Wet Lines
- Dump and Refuse Vehicles
- Bulk Liquid Transfer

Flow Data

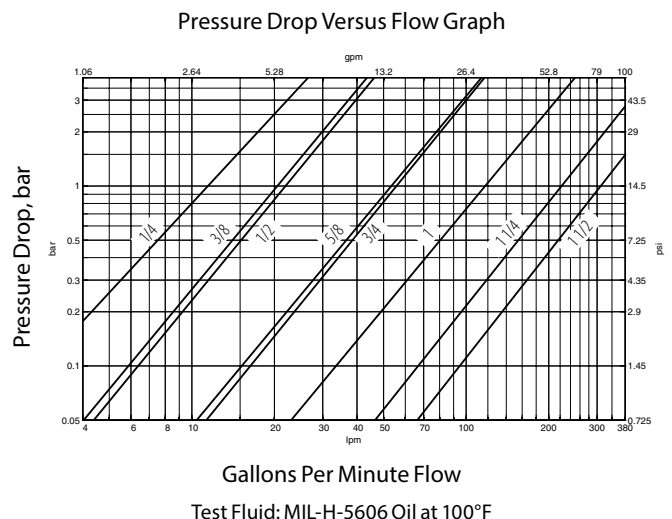

5100 Series

Thread to Connect

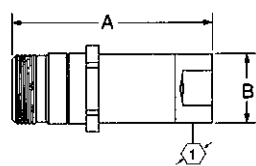

Figure 1

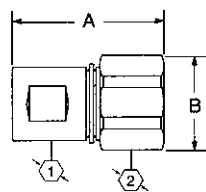

Figure 2

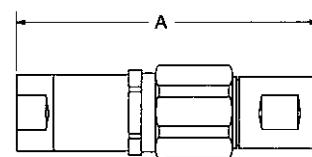

Figure 3

Dimensions (Female NPT, Valved without Flange)

Part Number (NBR)	Coupling Type	Body Size	Port Size	Thread	Type	Dimensions Fig.	A		B		Hex ①		Hex ②	
							mm	(in)	mm	(in)	mm	(in)	mm	(in)
5100-S2-4B	Plug/Male	¼	⅜	⅜-27	Female NPT	1	47.8	(1.88)	22.9	(.90)	17.5	(.69)	-	-
5110-S5-4B	Socket/Female	¼	⅜	⅜-27	Female NPT	2	53.3	(2.10)	33.5	(1.32)	14.2	(.56)	30.2	(1.19)
5111-4B	Complete	¼	⅜	⅜-27	Female NPT	3	81.3	(3.20)	-	-	-	-	-	-
5100-S2-6B	Plug/Male	⅜	¼	¼-18	Female NPT	1	65.5	(2.58)	26.7	(1.05)	23.9	(.94)	-	-
5110-S5-6B	Socket/Female	⅜	¼	¼-18	Female NPT	2	61.0	(2.40)	38.9	(1.53)	19.3	(.76)	35.1	(1.38)
5111-6B	Complete	⅜	¼	¼-18	Female NPT	3	104.4	(4.11)	-	-	-	-	-	-
5100-S2-8B	Plug/Male	½	⅝	⅝-18	Female NPT	1	65.5	(2.58)	26.7	(1.05)	23.9	(.94)	-	-
5110-S5-8B	Socket/Female	½	⅝	⅝-18	Female NPT	2	61.0	(2.40)	38.9	(1.53)	19.3	(.76)	35.1	(1.38)
5111-8B	Complete	½	⅝	⅝-18	Female NPT	3	104.4	(4.11)	-	-	-	-	-	-
5100-S2-10B	Plug/Male	¾	½	½-14	Female NPT	1	79.0	(3.11)	35.1	(1.38)	30.2	(1.19)	-	-
5110-S5-10B	Socket/Female	¾	½	½-14	Female NPT	2	78.0	(3.07)	50.3	(1.98)	29.5	(1.16)	44.5	(1.75)
5111-10B	Complete	¾	½	½-14	Female NPT	3	132.3	(5.21)	-	-	-	-	-	-
5100-S2-12B	Plug/Male	¾	¾	¾-14	Female NPT	1	79.0	(3.11)	35.1	(1.38)	30.2	(1.19)	-	-
5110-S5-12B	Socket/Female	¾	¾	¾-14	Female NPT	2	78.0	(3.07)	50.3	(1.98)	29.5	(1.16)	44.5	(1.75)
5111-12B	Complete	¾	¾	¾-14	Female NPT	3	132.3	(5.21)	-	-	-	-	-	-
5100-S2-16B	Plug/Male	1	1	1-11½	Female NPT	1	90.2	(3.55)	44.2	(1.74)	39.6	(1.56)	-	-
5110-S5-16B	Socket/Female	1	1	1-11½	Female NPT	2	93.5	(3.68)	61.2	(2.41)	36.6	(1.44)	53.8	(2.12)
5111-16B	Complete	1	1	1-11½	Female NPT	3	151.9	(5.98)	-	-	-	-	-	-
5100-S2-20B	Plug/Male	1¼	1¼	1¼ - 11½	Female NPT	1	94.2	(3.71)	52.8	(2.08)	47.8	(1.88)	-	-
5110-S5-20B	Socket/Female	1¼	1¼	1¼ - 11½	Female NPT	2	101.6	(4.00)	58.7	(2.31)	45.2	(1.78)	63.5	(2.50)
5111-20B	Complete	1¼	1¼	1¼ - 11½	Female NPT	3	160.3	(6.31)	-	-	-	-	-	-
5100-S2-24B	Plug/Male	1½	1½	1½ - 11½	Female NPT	1	104.6	(4.12)	62.5	(2.46)	55.6	(2.19)	55.6	(2.19)
5110-S5-24B	Socket/Female	1½	1½	1½ - 11½	Female NPT	2	104.1	(4.10)	78.7	(3.10)	50.8	(2.00)	-	-
5111-24B	Complete	1½	1½	1½ - 11½	Female NPT	3	165.6	(6.52)	-	-	-	-	-	-

5100 Series

Thread to Connect

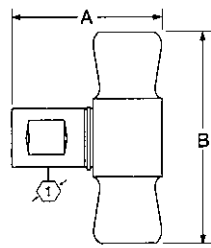

Figure 6

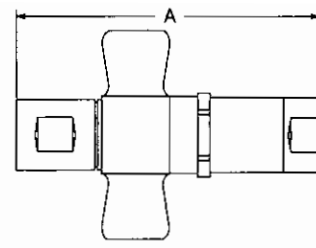

Figure 7

Dimensions (Female NPT, Valved WITH Wing Nut Less Flange)

Part Number (NBR)	Coupling Type	Body Size	Port Size	Thread	Type	Fig.	Dimensions				Hex ①	
							A		B		mm	(in)
5100-S5-4B	Socket/Female	¼	⅙	⅙-27	Female NPT	6	53.3	(2.10)	77.0	(3.03)	14.2	(.56)
5101-4B	Complete	¼	⅙	⅙-27	Female NPT	7	81.3	(3.20)	-	-	-	-
5100-S5-6B	Socket/Female	⅜	¼	¼-18	Female NPT	6	61.0	(2.40)	87.4	(3.44)	19.3	(.76)
5101-6B	Complete	⅜	¼	¼-18	Female NPT	7	104.4	(4.11)	-	-	-	-
5100-S5-8B	Socket/Female	½	⅜	⅜-18	Female NPT	6	61.0	(2.40)	87.4	(3.44)	19.3	(.76)
5101-8B	Complete	½	⅜	⅜-18	Female NPT	7	104.4	(4.11)	-	-	-	-
5100-S5-10B	Socket/Female	⅝	½	½-14	Female NPT	6	78.0	(3.07)	104.9	(4.13)	29.5	(1.16)
5101-10B	Complete	⅝	½	½-14	Female NPT	7	132.3	(5.21)	-	-	-	-
5100-S5-12B	Socket/Female	¾	¾	¾-14	Female NPT	6	78.0	(3.07)	104.9	(4.13)	29.5	(1.16)
5101-12B	Complete	¾	¾	¾-14	Female NPT	7	132.3	(5.21)	-	-	-	-
5100-S5-16B	Socket/Female	1	1	1-11½	Female NPT	6	93.5	(3.68)	111.3	(4.38)	36.6	(1.44)
5101-16B	Complete	1	1	1-11½	Female NPT	7	151.9	(5.98)	-	-	-	-
5100-S5-20B	Socket/Female	1¼	1¼	1¼-11½	Female Pipe	6	101.6	(4.00)	133.9	(5.27)	45.2	(1.78)
5101-20B	Complete	1¼	1¼	1¼-11½	Female NPT	7	160.3	(6.31)	-	-	-	-
5100-S5-24B	Socket/Female	1½	1½	1½-11½	Female NPT	6	104.1	(4.10)	136.7	(5.38)	50.8	(2.00)
5101-24B	Complete	1½	1½	1½-11½	Female NPT	7	165.6	(6.52)	-	-	-	-

5100 Series

Thread to Connect

Dust Caps and Dust Plugs

Part Number Dust Cap with Chain	Dust Plug with Chain	Body Size
5100-S7-5	5100-S9-5	¼
5100-S7-8	5100-S9-8	¾ & ½
5100-S7-12	5100-S9-12	¾ & ¾
5100-S7-16	5100-S9-16	1
5100-S7-20	5100-S9-20	1¼
5100-S7-24	5100-S9-24	1½

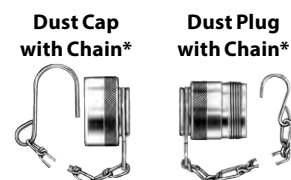

6-Bolt Flange Assembly

Part Number 6-Bolt Flange Assembly	Body Size	Dimensions A		Dimensions B	
		mm	(in)	mm	(in)
150-22-5	¼	5.11	(.201)	33.6	(1.44)
150-22-8	¾ & ½	5.11	(.201)	42.9	(1.69)
150-22-12	¾ & ¾	5.11	(.201)	53.8	(2.12)
150-22-16	1	5.11	(.201)	60.5	(2.38)
150-22-20	1¼	5.11	(.201)	66.5	(2.62)
5100-22-245	1½	5.11	(.201)	82.6	(3.25)

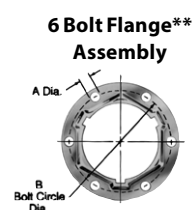

*To order caps and plugs without chain, order cap by part number 5100-32-(size) and plug by part number 5100-41-(size).

**6 Bolt Flange -holes equally spaced. (See "A" for bolt hole diameter, and "B" for bolt circle diameter).

FD85 Series

Thread to Connect

Fluid transfer & Hydraulic application



The Danfoss Hansen FD85 Series is a thread to connect coupling most commonly used in Oil and Gas applications, but can also be found on demanding applications on both mobile and stationary equipment where operating pressures of 5,000 psi are present.

Product Features

- Thread to connect feature allows for use in high vibration and impulse applications
- Standard body material: Zinc trivalent plated carbon steel. Stainless steel construction available upon request
- Connect under pressure capability up to 5,000 psi (345 bar)
- Standard seal material: Nitrile (NBR), FKM seals are available upon request
- Wing nut and hex flat design allows for easy connection and disconnection
- 3/4" design is offered in a hex nut design
- Female NPTF and BSPP ends available

Physical Characteristics

Body Size (in)	Maximum Operating Pressure					Minimum Burst Pressure					Rated Flow L/min (gpm)	Fluid Loss ml-cc.	Air Inclusion ml-cc.			
	Connected		Plug/Male Half		Socket/Female Half		Connected		Plug/Male Half					Socket/Female Half		
	bar	(psi)	bar	(psi)	bar	(psi)	bar	(psi)	bar	(psi)				bar	(psi)	
3/4"	345	5,000	345	5,000	345	5,000	1,380	20,000	1,380	20,000	1,380	20,000	100	26.4	10	10
1"	345	5,000	345	5,000	345	5,000	1,380	20,000	1,380	20,000	1,380	20,000	189	50	20	26
1 1/4"	345	5,000	345	5,000	345	5,000	1,035	15,000	1,035	15,000	1,035	15,000	288	76	20	40
1 1/2"	345	5,000	345	5,000	345	5,000	1,035	15,000	1,035	15,000	1,035	15,000	379	100	83	85
2"	345	5,000	345	5,000	345	5,000	1,035	15,000	1,035	15,000	1,035	15,000	757	200	181	240

Applications & Markets

- Oilfields
- Offshore Drilling
- Construction
- Oil and Gas

Lloyd's Register Certification

The FD85 Series carries a Lloyd's Registry Certificate for fire conditions outlined in API 16D and EUB Directive 36. These parts meet the requirements that couplings shall be capable of maintaining pressure when exposed to a 700°C (1,300°F) temperature for a five-minute period in connected state.

Certification only applies to those assemblies where both mating parts socket/female and plug/male are Danfoss FD85 Series thread to connect couplings.

Flow Data

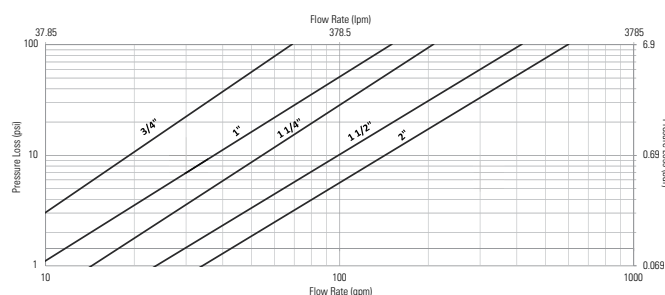

FD85 Series

Thread to Connect

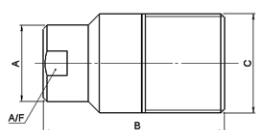

Figure 1

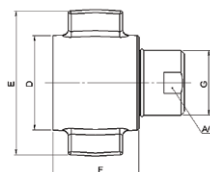

Figure 2

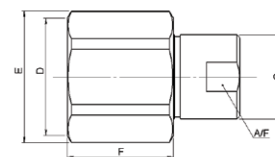

Figure 3

Plugs (Male)

Part Number	Body Size	Thread Size (Female)		Fig.	Dimensions						Weight			
		NPT	BSPP		A (in)	B (in)	C (in)	A (mm)	B (mm)	C (mm)	A/F (in)	A/F (mm)	Lbs	grams
FD85-1001-12-12	¾	¾-14	–	1	1.39	3.27	1.74	35.2	83.1	44.3	1 1/3	33	1.162	480
FD85-1017-12-12	¾	–	G ¾-14	1	1.39	3.27	1.74	35.2	83.1	44.3	1 1/3	33	1.162	480
FD85-1001-16-16	1	1-11 1/2	–	1	1.77	4.17	2.25	45	106	57.1	1 5/8	41	2.921	1120
FD85-1017-16-16	1	–	G 1 - 11	1	1.77	4.17	2.25	45	106	57.1	1 5/8	41	2.974	1120
FD85-1001-20-20	1 ¼	1 ¼ - 11	–	1	2.15	5.37	2.62	54.5	136.4	66.6	2	50	5.633	1875
FD85-1017-20-20	1 ¼	–	G 1 ¼ - 11	1	2.15	5.37	2.62	54.5	136.4	66.6	2	50	5.633	1875
FD85-1001-24-24	1 ½	1 ½ - 11 ½	–	1	2.5	5.99	3.25	63.5	152.2	82.55	2 3/8	60	7.721	3150
FD85-1017-24-24	1 ½	–	G 1 ½ - 11	1	2.5	5.99	3.25	63.5	152.2	82.55	2 3/8	60	7.721	3150
FD85-1001-32-32	2	2 - 11 ½	–	1	3.25	7	4	82.5	179.2	101.6	3	76	15.046	5635
FD85-1017-32-32	2	–	G 2" - 11	1	3.25	7	4	82.5	179.2	101.6	3	76	15.046	5635

Sockets (Female)

Part Number	Body Size	Thread Size (Female)		Fig.	Dimensions								Weight			
		NPT	BSPP		D (in)	E (in)	F (in)	G (in)	D (mm)	E (mm)	F (mm)	G (mm)	A/F (in)	A/F (mm)	Lbs	grams
FD85-1003-12-12	¾	¾-14	–	3	1.94	2.17	1.74	1.39	49.2	55	44.3	35.2	1 1/3	33	1.162	527
FD85-1019-12-12	¾	–	G ¾-14	3	1.94	2.17	1.74	1.39	49.2	55	44.3	35.2	1 1/3	33	1.162	527
FD85-1003-16-16	1	1-11 ½	–	2	2.68	4.25	2.2	1.77	68	108	56	45	1 5/8	41	2.921	1325
FD85-1019-16-16	1	–	G 1 - 11	2	2.68	4.25	2.2	1.77	68	108	56	45	1 5/8	41	2.974	1349
FD85-1003-20-20	1 ¼	1 ¼ - 11	–	2	3.15	4.72	2.8	2.15	80	120	71	54.5	2	50	5.633	2555
FD85-1019-20-20	1 ¼	–	G 1 ¼ - 11	2	3.15	4.72	2.8	2.15	80	120	71	54.5	2	50	5.633	2555
FD85-1003-24-24	1 ½	1 ½ - 11 ½	–	2	3.66	5.67	3.31	2.5	93	144	84	63.5	2 3/8	60	7.721	3502
FD85-1019-24-24	1 ½	–	G 1 ½ - 11	2	3.66	5.67	3.31	2.5	93	144	84	63.5	2 3/8	60	7.721	3502
FD85-1003-32-32	2	2 - 11 ½	–	2	4.67	6.67	4.35	3.25	118.6	169.4	110.5	82.5	3	76	15.046	6825
FD85-1019-32-32	2	–	G 2 - 11	2	4.67	6.67	4.35	3.25	118.6	169.4	110.5	82.5	3	76	15.046	6825

FD86 Series

Thread to Connect

5,000 psi Dry Break – High Impulse

Fluid transfer & Hydraulic application



Danfoss Hansen FD86 Series is a thread together steel quick coupling offering dry break and high impulse technology and capabilities. The maximum operating pressure is 5,000 psi. The FD86 Series is available in either wing nut or hex nut configurations for ease of assembly and disassembly. (For higher pressure applications and additional size requirements, refer to FD96 on page 76.)

Product Features

- Tubular valve and sleeve construction for low fluid loss and air inclusion
- Thread together design using wing or hex nut allows connection and disconnection against pressures up to 750 psi
- Teflon back-up rings along with secondary metal-to-metal sealing contact provides high impulse capability up to 5,000 psi operating pressure
- Acme threads prevent galling and provide ease of connection
- Steel flange available for bulkhead mounting
- Standard seal material: Nitrile (NBR)
- Standard body material: High resistance carbon steel with zinc trivalent plating

Physical Characteristics

Body Size (in)	Max. Operating Pressure		Min. Burst (bar)	Vacuum Connected Only (psi)	Rated Flow (in./Hg)	Air Inclusion		Fluid Loss	
	(bar)	(psi)				(lpm)	(gpm)	cc. max.	cc.max.
1	345	5,000	1,034	15,000	28	189	50	2.90	0.72
1¼	345	5,000	1,034	15,000	28	284	75	4.61	1.00

Applications & Markets

- Hydraulic and Fluid Transfer
- Mining Equipment

Flow Data

Pressure Drop Versus Flow Graph

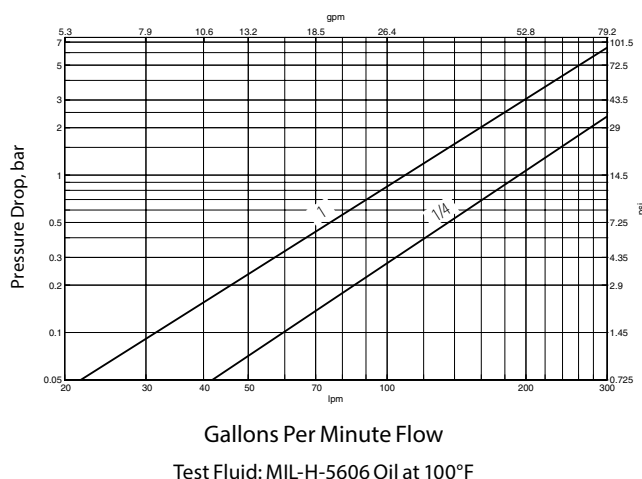

FD86 Series

Thread to Connect 5,000 psi Dry Break – High Impulse

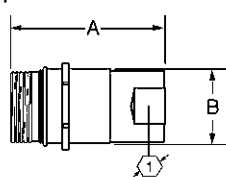

Figure 1

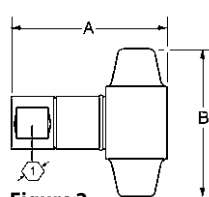

Figure 2

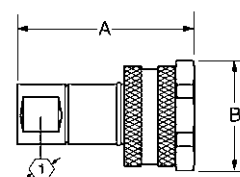



Figure 3

Dimensions (Female SAE O-Ring)

Part Number NBR	FKM	EPDM	Type	Body Size	Port Size	Thread	Type	Fig.	Dimensions					
									A		B		Hex 	
									mm	(in)	mm	(in)	mm	(in)
FD86-1008-16-16	FD86-1043-16-16	FD86-1053-16-16	Plug/Male	1	1 $\frac{5}{16}$	1 $\frac{5}{16}$ - 12	Female SAE O-Ring	1	102.4	(4.03)	53.6	(2.11)	44.5	(1.75)
FD86-1010-16-16	FD86-1044-16-16	FD86-1054-16-16	Socket/Female	1	1 $\frac{5}{16}$	1 $\frac{5}{16}$ - 12	Female SAE O-Ring	2	117.3	(4.62)	114.3	(4.50)	-	-
FD86-1006-16-16	FD86-1042-16-16	FD86-1052-16-16	Socket/Female	1	1 $\frac{5}{16}$	1 $\frac{5}{16}$ - 12	Female SAE O-Ring	3	117.3	(4.62)	71.4	(2.81)	15.8	(1.62)
FD86-1008-20-20	FD86-1043-20-20	FD86-1053-20-20	Plug/Male	1 $\frac{1}{4}$	1 $\frac{1}{8}$	1 $\frac{1}{8}$ - 12	Female SAE O-Ring	1	105.7	(4.16)	63.0	(2.48)	57.2	(2.25)
FD86-1010-20-20	FD86-1044-20-20	FD86-1054-20-20	Socket/Female	1 $\frac{1}{4}$	1 $\frac{1}{8}$	1 $\frac{1}{8}$ - 12	Female SAE O-Ring	2	132.6	(5.22)	133.4	(5.25)	-	-
FD86-1006-20-20	FD86-1042-20-20	FD86-1052-20-20	Socket/Female	1 $\frac{1}{4}$	1 $\frac{1}{8}$	1 $\frac{1}{8}$ - 12	Female SAE O-Ring	3	132.6	(5.22)	86.4	(3.40)	50.8	(2.00)

Dimensions (Female NPT)

Part Number NBR	FKM	EPDM	Type	Body Size	Port Size	Thread	Type	Fig.	Dimensions					
									A		B		Hex 	
									mm	(in)	mm	(in)	mm	(in)
FD86-1002-16-16	FD86-1040-16-16	FD86-1050-16-16	Plug/Male	1	1 - 11 $\frac{1}{2}$	1 - 11 $\frac{1}{2}$	Female NPT	1	111.8	(4.40)	53.6	(2.11)	44.5	(1.75)
FD86-1001-16-16	FD86-1039-16-16	FD86-1049-16-16	Socket/Female	1	1 - 11 $\frac{1}{2}$	1 - 11 $\frac{1}{2}$	Female NPT	2	126.5	(4.98)	114.3	(4.50)	-	-
FD86-1004-16-16	FD86-1041-16-16	FD86-1051-16-16	Socket/Female	1	1 - 11 $\frac{1}{2}$	1 - 11 $\frac{1}{2}$	Female NPT	3	126.5	(4.98)	71.4	(2.81)	15.8	(1.62)
FD86-1002-20-20	FD86-1040-20-20	FD86-1050-20-20	Plug/Male	1 $\frac{1}{4}$	1 $\frac{1}{4}$ - 11 $\frac{1}{2}$	1 $\frac{1}{4}$ - 11 $\frac{1}{2}$	Female NPT	1	112.5	(4.43)	63.0	(2.48)	57.2	(2.25)
FD86-1001-20-20	FD86-1039-20-20	FD86-1049-20-20	Socket/Female	1 $\frac{1}{4}$	1 $\frac{1}{4}$ - 11 $\frac{1}{2}$	1 $\frac{1}{4}$ - 11 $\frac{1}{2}$	Female NPT	2	142.8	(5.62)	133.4	(5.25)	-	-
FD86-1004-20-20	FD86-1041-20-20	FD86-1051-20-20	Socket/Female	1 $\frac{1}{4}$	1 $\frac{1}{4}$ - 11 $\frac{1}{2}$	1 $\frac{1}{4}$ - 11 $\frac{1}{2}$	Female NPT	3	142.8	(5.62)	86.4	(3.40)	50.8	(2.00)

Repair Kits

Part Number NBR	FKM	EPDM	Body Size	Coupling Type
FF10596-16	FF10597-16	FF10598-16	1	Male
FF10593-16	FF10594-16	FF10595-16	1	Female
FF10596-20	FF10597-20	FF10598-20	1 $\frac{1}{4}$	Male
FF10593-20	FF10594-20	FF10595-20	1 $\frac{1}{4}$	Female

Dust Caps and Dust Plugs

Part Number Dust Cap with Chain	Dust Plug with Chain	Body Size
FD86-1018-16	FD86-1016-16	1
FD86-1018-20	FD86-1016-20	1 $\frac{1}{4}$

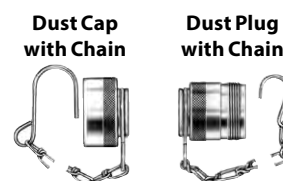

W46000 Series

Fluid transfer & Hydraulic application

Danfoss Hansen W46000 Series is a wing nut style screw to connect coupling used in hydraulic applications.



Product Features

- Wing nut screw to connect
- Plug/Male half has bulkhead mount capability
- Metal dust caps and dust plugs
- Standard body material: Zinc trivalent plated steel
- Standard seal material: Nitrile

Physical Characteristics

Coupling Size	DN/ND	Max. Operating Pressure		Min. Burst Pressure		Rated Flow		Air Inclusion
(in)		(bar)	(psi)	(bar)	(psi)	(lpm)	(gpm)	ml max
3/4	16	250	3625	1200	17404	63	16,7	10
1	20	230	3335	800	11603	99	26,0	15

Applications & Markets

- Hydraulic Circuits

Flow Data

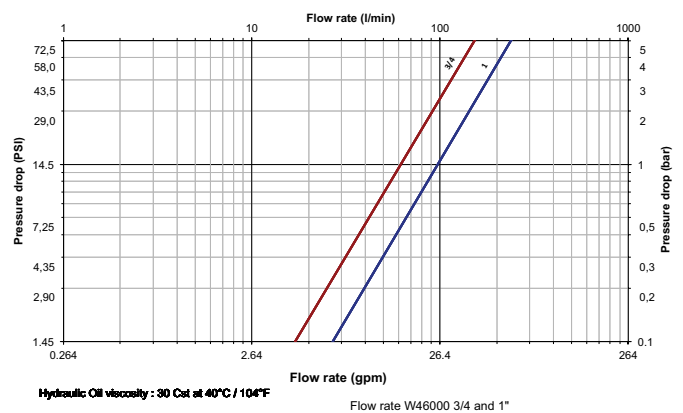

Size	DN/ND	Socket/Female	Socket Dust Cap Only	Coupling Type	Connection	Dimensions			
						L1	1	Hex 1	
(in)						(mm)	(mm)	(mm)	
3/4	16	WA4604700	WA4614700	Socket/Female	G 3/4	77	M5	33	
1	20	WA4605700	WA4615700	Socket/Female	G1	83	M6	40	
Size	DN/ND	Plug/Male	Plug Dust Cap Only	Coupling Type	Connection	Dimensions			
						L2	2	Hex 2	Hex 3
(in)						(mm)	(mm)	(mm)	(mm)
3/4	16	WA4604400	WA4614400	Plug/Male	G 3/4	78	G 1" 1/4	46	50
1	20	WA4605400	WA4615400	Plug/Male	G 1	83	G 1" 1/4	55	50

Couplings for high-pressure applications



Table of Contents

Screw to connect

HP3 Series.....	107
W56000 Series	108

Ball latch

FD35 Series.....	109
UH Series.....	111

HP3 Series

High Pressure Application

Danfoss Hansen HP3 Series Hydraulic Jack/Enerpac Interchange is designed for high-pressure applications up to 700 bar (10,000 psi).



Product Features

- Thread together design
- 700 bar (10,000 psi) operating pressure
- Ball valve
- Seal material: Nitrile (NBR)
- Body material: High-resistance carbon steel with zinc trivalent chromate plating

Applications & Markets

- Hydraulic jack
- Portable hydraulic rams

Physical Characteristics

Body Size (in)	Max. Operating Pressure (Static)		Min. Burst Pressure		Rated Flow	
	Connected (bar)	Connected (psi)	Connected (bar)	Connected (psi)	(lpm)	(gpm)
3/8	700	10,000	2200	31,900	23	6

* Connect and disconnect under pressure not allowed

Dimensions

Part Number	Coupling Type	Body Size	Port Size	Thread	Type	Fig.	Dimensions					
							A	B	Hex	⊕		
							mm	(in)	mm	(in)	mm	(in)
HP3SB37M	Socket/Female	3/8	3/8	3/8-18	Male NPT	1	72.2	(2.84)	35.0	(1.38)	24	.94
HP3PB37F	Plug/Male	3/8	3/8	3/8-18	Female NPT	2	40.0	(1.57)	35.0	(1.38)	32	1.26

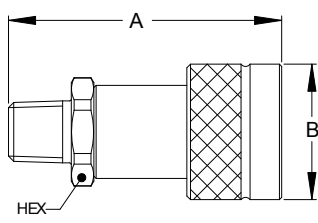

Figure 1

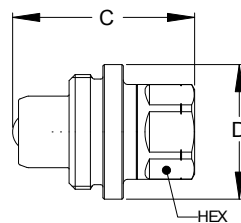
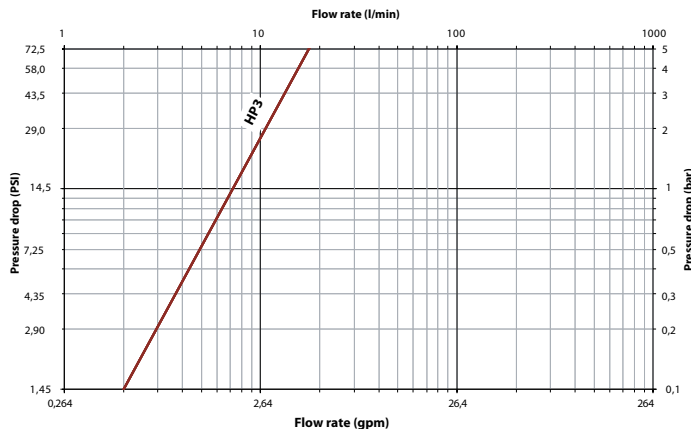

Figure 2

Flow Data



Hydraulic Oil viscosity : 30 Cst at 40°C / 104°F

Dust Caps and Dust Plugs

Body Size	Dust Cap	Dust Plug
3/8	WA5612400	WA5612700



W56000 Series

High Pressure Application

Danfoss Hansen W56000 Series is a screw to connect coupling designed to operate at pressures exceeding 10,000 psi or 700 bar. Rugged design makes these couplings suitable for hydraulic jacks and lift loading.



Product Features

- Screw to connect double shut off with poppet valve
- Designed and manufactured under Article 4.3 of the European Pressure Equipment Directive PED 2014/68/EU.
- Interchanges with other couplings with the same profile
- Standard body material: Zinc trivalent plated steel
- Standard seal material: Nitrile (NBR)

Physical Characteristics

Coupling Size (in)	DN/ND	Max. Operating Pressure		Min. Burst Pressure		Rated Flow		Air Inclusion
		(bar)	(psi)	(bar)	(psi)	(lpm)	(gpm)	ml max
1/4	5.7	700	10,000	2,800	40,000	11	2.9	1.1
3/8	7.6	700	10,000	2,800	40,000	16	4.2	1.7

Applications & Markets

- Hydraulic Jacks, Lifts
- Emergency Rescue Equipment

Flow Data

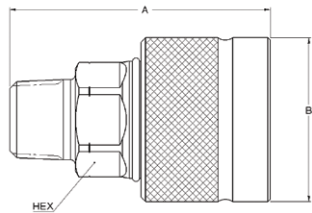
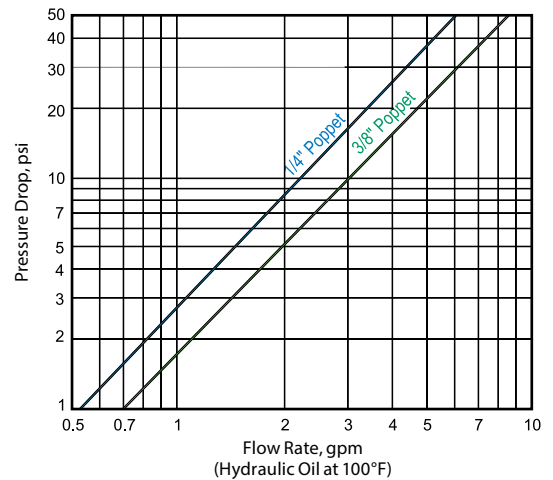

Figure 1

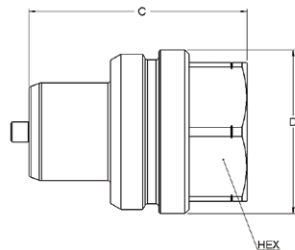

Figure 2

Part Number	DN/ND	Body Size	Coupling Type	Connection	Fig.	Dimensions					
						A	B	Hex	A	B	Hex
						(in)	(in)	(in)	(mm)	(mm)	(mm)
WA5651700	5.7	1/4	Socket/Female	1/4 NPT Male	1	2.44	1.12	.87	62	28.5	22
WA5652700	7.6	3/8	Socket/Female	3/8 NPT Male	1	2.19	1.38	.87	55.6	35	22
Part Number	DN/ND	Body Size	Coupling Type	Connection	Fig.	Dimensions					
						C	D	Hex	C	D	Hex
						(in)	(in)	(in)	(mm)	(mm)	(mm)
WA5651400	5.7	1/4	Plug/Male	1/4 NPT Female	2	1.26	1.10	.75	32	28	19
WA5652400	7.6	3/8	Plug/Male	3/8 NPT Female	2	1.65	1.26	1.06	42	32	27

Dust Caps and Dust Plugs

Body Size	Dust Cap	Dust Plug
1/4	WA5611400	WA5611700
3/8	WA5612400	WA5612700



FD35 Series

10,000 psi Ball Latch

High Pressure Application



Danfoss Hansen FD35 Series ball latch has a greater surface contact area for long surface life in rugged high pressure applications. The maximum operating pressure is 10,000 psi.

Product Features

- Safety sleeve lock prevents accidental disconnection
- Heavy duty back-up ring prevents O-Ring extrusion
- Heat-treated and plated steel for greater wear and corrosion resistance
- Self-sealing poppet valves provide excellent high-and low-pressure sealing
- Standard seal material: FKM
- Standard body material: High-resistance carbon steel with Zinc trivalent plating

Physical Characteristics

Body Size	Max. Operating Pressure		Min. Burst Pressure		Vacuum Connected Only	Rated Flow		Air Inclusion	Fluid Loss
	(bar)	(psi)	(bar)	(psi)	(in./Hg)	(lpm)	(gpm)	cc. max.	cc.max.
3/8	700	10,000	2,800	40,000	28	8	2	0.50	0.50

Applications & Markets

- 10,000 psi Hydraulic Applications
- Hydraulic Tool
- Hydraulic Ram and Work Loading

Flow Data

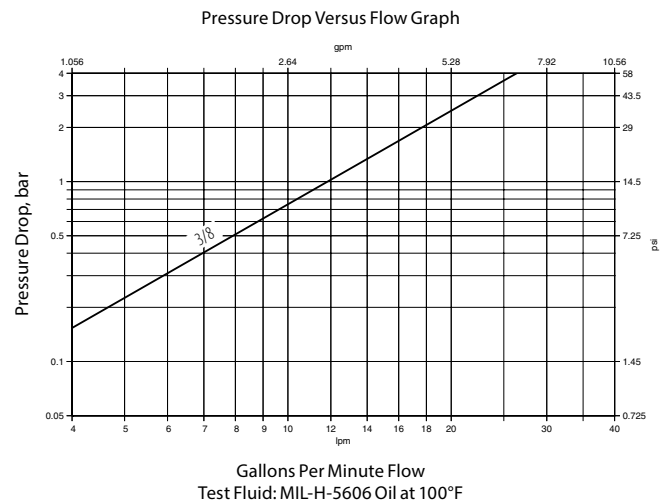

FD35 Series

10,000 psi

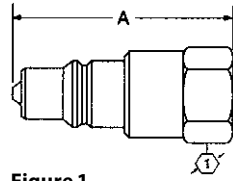

Figure 1

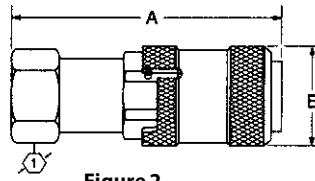

Figure 2

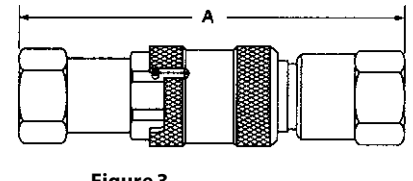

Figure 3

Dimensions (Female NPT, Valved)

Part Number	Coupling Type	Body Size	Port Size	Thread	Type	Fig.	Dimensions A		B		Hex ①	
							mm	(in)	mm	(in)	mm	(in)
FD35-1002-06-06	Plug/Male	3/8	3/8	3/8-18	Female NPT	1	53.8	(2.12)	-	-	23.9	(.94)
FD35-1001-06-06	Socket/Female	3/8	3/8	3/8-18	Female NPT	2	65.0	(2.56)	32.3	(1.27)	23.9	(.94)
FD35-1000-06-06	Complete	3/8	3/8	3/8-18	Female NPT	3	89.9	(3.54)	-	-	-	-

Dimensions (Female SAE O-Ring, Valved)

Part Number	Coupling Type	Body Size	Port Size	Thread	Type	Fig.	Dimensions A		B		Hex ①	
							mm	(in)	mm	(in)	mm	(in)
FD35-1008-06-06	Plug/Male	3/8	1/16	3/8-18	Female SAE O-Ring	1	53.8	(2.12)	-	-	23.9	(.94)
FD35-1007-06-06	Socket/Female	3/8	1/16	3/8-18	Female SAE O-Ring	2	65.0	(2.56)	32.3	(1.27)	23.9	(.94)
FD35-1006-06-06	Complete	3/8	1/16	3/8-18	Female SAE O-Ring	3	89.9	(3.54)	-	-	-	-

Dimensions (Female SAE O-Ring, 125 PSI Bleed Valve)

Part Number	Coupling Type	Body Size	Port Size	Thread	Type	Fig.	Dimensions A		Hex ①	
							mm	(in)	mm	(in)
FD35-1052-06-06	Plug/Male	3/8	1/16	3/8-18	Female SAE O-Ring	1	53.8	(2.12)	23.9	(.94)

Note: Incorporates a special relief valve set at 125 psi, preventing disconnected pressure build-up.

Dust Cap/Plug

Part Number	Body Size
FD35-1042-06	3/8

Note: Fits male and female halves



Dust Cap/Plug

UH Series

High Pressure Application



Danfoss Hansen 2UH series is a ball latch coupling used in ultra high pressure application up to 14,500 psi or 1,000 bar. The connection can be made with a push-to connect system. The standard body material is high tensile steel with anticorrosion finish to offer extended lifetime in the application.

Product Features

- Ultra high pressure resistance
- Standard body material: high tensile steel with anticorrosion finish, hardened steel sleeve
- PVC dust caps and plugs

Applications & Markets

- Windmill turbines
- Ultra high pressure equipment

Physical characteristics

Body Size	Working Pressure		Nominal Flow Diameter (mm)	Socket part number	Thread Size (Female)	Fig	Socket dimensions					
	(bar)	(psi)					A (mm)	B (mm)	Hex (mm)	A (in)	B (in)	Hex (in)
1/4"	1000	14503	2.5	2UHS25BSS12	1/4 BSPP	1	59	27	24	2,32	1,06	0,94

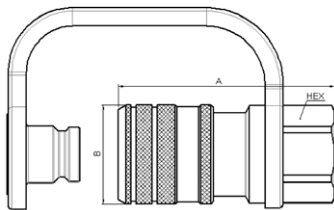
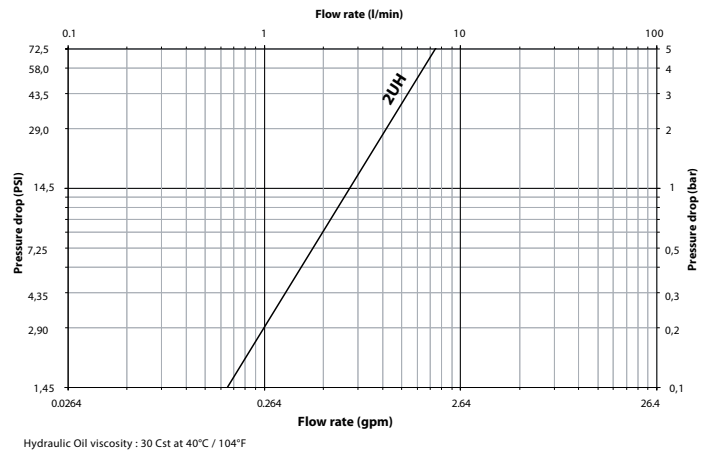

Figure 1

Flow Data



Couplings for water blast applications



Table of Contents

FD69 Series.....	114
------------------	-----

FD69 Series

10,000 psi Water Blast

Water blast application



Danfoss Hansen FD69 Series design has a greater surface contact area for long service life in rugged high pressure and water blast applications. The maximum operating pressure is 10,000 psi with 40,000 psi minimum burst pressure.

Product Features

- Safety sleeve lock guards against accidental disconnection
- Smooth bore "straight through" design for high flow fluid requirements
- Heavy duty back-up ring to prevent O-Ring extrusion
- Available in plated steel and stainless steel for added corrosion resistance
- Standard seal material: Nitrile (NBR)
- Standard body material: High resistance carbon steel with Zinc trivalent plating or stainless steel

Physical Characteristics

Coupling Size (in)	Max. Operating Pressure		Min. Burst Pressure Connected		Vacuum Connected Only	Rated Flow		Air Inclusion	Fluid Loss
	(bar)	(psi)	(bar)	(psi)	(in./Hg)	(lpm)	(gpm)	cc. max.	cc.max.
½	689	10,000	2,758	40,000	28	170	45	-	-

Applications & Markets

- High pressure WaterBlast
- Bridge/Concrete Repair
- Paint Stripping
- Shipyards

Flow Data

Pressure Drop Versus Flow Graph

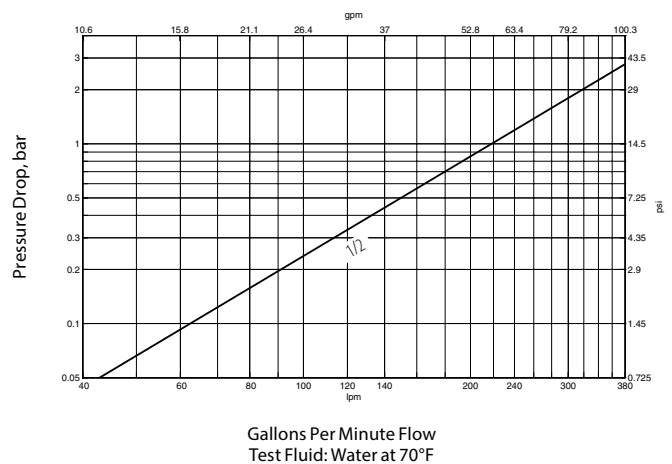

FD69 Series

10,000 psi Water Blast

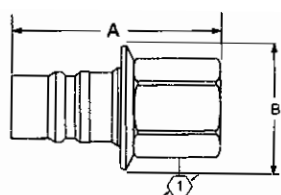

Figure 1

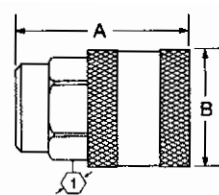

Figure 2

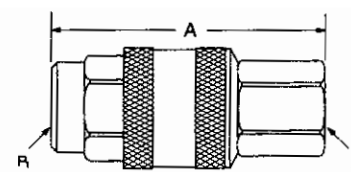

Figure 3

Dimensions (Female NPT)

Part Number NBR	FKM	EPDM	Coupling Type	Body Size	Port Size	Thread	Type	Fig.	Dimensions			Hex	Ⓛ		
									A	B					
										mm	(in)	mm	(in)	mm	(in)
Steel															
FD69-1002-06-08	FD69-1002-06-08	FD69-1002-06-08	Plug/Male*	½	¾	¾-18	Female NPT	1	47.0	(1.85)	41.7	(1.64)	25.4	(1.00)	
FD69-1001-06-08	FD69-1026-06-08	FD69-1028-06-08	Socket/Female	½	¾	¾-18	Female NPT	2	54.1	(2.13)	41.1	(1.62)	31.8	(1.25)	
FD69-1002-08-08	FD69-1002-08-08	FD69-1002-08-08	Plug/Male*	½	½	½-14	Female NPT	1	59.4	(2.34)	41.7	(1.64)	28.4	(1.12)	
FD69-1001-08-08	FD69-1026-08-08	FD69-1028-08-08	Socket/Female	½	½	½-14	Female NPT	2	54.1	(2.13)	41.1	(1.62)	31.8	(1.25)	
Stainless Steel															
FD69-1012-08-08	FD69-1012-08-08	FD69-1012-08-08	Plug/Male*	½	½	½-14	Female NPT	1	59.4	(2.34)	41.7	(1.64)	28.4	(1.12)	
FD69-1011-08-08	-	-	Socket/Female	½	½	½-14	Female NPT	2	54.1	(2.13)	41.1	(1.62)	33.3	(1.31)	

*Male halves contain no seals.

Part Number NBR	FKM	EPDM	Coupling Type	Body Size	Port Size	Thread		Type	Fig.	Dimensions A	
						(P)	(P1)			mm	(in)
Steel											
FD69-1000-080808	FD69-1027-080808	FD69-1029-080808	Complete	½	½	½-14	½-14	Female NPT	3	87.1	(3.43)
FD69-1000-080806	FD69-1027-080806	FD69-1029-080806	Complete	½	½ & ¾	½-14	¾-18	Female NPT	3	87.1	(3.43)
FD69-1000-060808	FD69-1027-060808	FD69-1029-060808	Complete	½	¾ & ½	¾-18	½-14	Female NPT	3	74.7	(2.94)
FD69-1000-060806	FD69-1027-060806	FD69-1029-060806	Complete	½	¾	¾-18	¾-18	Female NPT	3	74.7	(2.94)
Stainless Steel											
FD69-1010-080808	-	-	Complete	½	½	½-14	½-14	Female NPT	3	87.1	(3.43)

Repair Kit, Female Interface Seal

Part Number NBR	Coupling Size
FF10166	½

Check valves



Table of Contents

R4000 Series.....	117
-------------------	-----

R4000 Series

(Steel)

Check valves



The Danfoss Hansen R4000 Series steel check valves are designed for multipurpose hydraulic applications to either allow flow of fluid in one direction only or limit the line's internal pressure to the cracking pressure. Standard cracking pressures are 0.5 and 1 bar (7.25 and 14.5 psi). Alternatives can be offered upon request.

Product Features

- Standard body material: Zinc-plated steel
- Standard seal material: NBR, FKM, EPDM

Operating Guidelines

The Danfoss R4000 series is designed to handle liquids. Should applications involving gases (but not unstable gases) be considered, the user should certify that sonic frequencies will not exceed 1 Hz (one cycle per second). For further information, please contact Danfoss technical support.

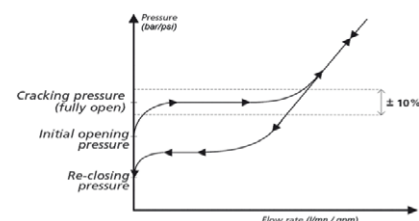

European Pressure Equipment Directive

Check valves with nominal diameters up to and including 25 mm are designed and manufactured under Article 4.3 of the European Pressure Equipment Directive PED 2014/68/EU. Check valves with nominal diameters greater than 25 mm are designed and manufactured with the stipulations of Module A of the European Pressure Equipment Directive PED 2014/68/EU. They should not be used to convey unstable gases. Our series R4000 check valves must not be used as safety devices (as per PED 2014/68/EU).

Physical Characteristics

Body Size	Nominal Flow Diameter	Max. Operating Pressure**				Rated Flow*	
		Non hazardous liquids & gases in Group 2		Hazardous liquids & gases in Group 1		L/min	(gpm)
(in)	(mm)	bar	(psi)	bar	(psi)		
1/8	3.8	700	10,150	700	10,150	4.5	1.19
1/4	5.7	700	10,150	700	10,150	14.2	3.75
3/8	7.6	700	10,150	700	10,150	22	5.81
1/2	10.3	500	7,250	500	7,250	32	8.45
3/4	14.2	500	7,250	500	7,250	72	19
1	16.5	500	7,250	500	7,250	117	30.9
1 1/4	20.5	300	4,350	300	4,350	188	49.66
1 1/2	25.8	300	4,350	38	550	232	61.29
2	34.7	300	4,350	28	405	393	103.81

*Indicated values refer to a 1 bar/14.5 psi pressure drop.

**Group 1 = Hazardous media / Group 2 = Other media

Applications & Markets

- All Industries
- Agriculture
- Construction
- Fluid Transfer Lines

Flow Data

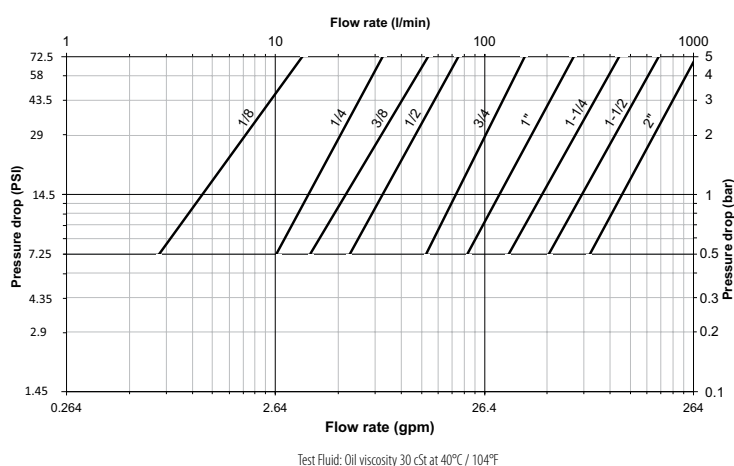

Seal Elastomer Data*

Seal Elastomer	Max. Operation Temperature Range
NBR (Nitrile)	-20°C +100°C / -4°F +212°F
FKM (Fluorocarbon)	-20°C +200°C / -4°F +392°F
EPDM (Ethylene-Propylene)**	-40°C +150°C / -40°F +302°F

*For reference only, based on Danfoss recommended temperatures.

**In accordance with NF L 17-241 or NAS 1613 rev. 5

Contact Danfoss technical support for further information on fluid compatibility.

R4000 Series

(Steel)

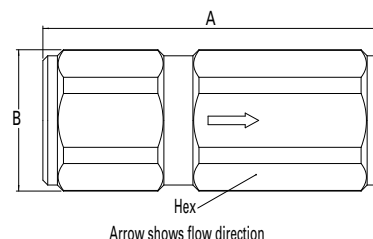

Figure 1

Cracking Pressure 0.5 bar (7.25 psi)

Part Number			Body Size (in)	Nominal Flow Diameter (mm)	Thread Size** (Female)	BSPP	Fig.	Dimensions						Weight	
NBR*	FKM	EPDM						A (in)	B (in)	Hex (in)	A (mm)	B (mm)	Hex (mm)	lbs	grams
RA0400000	RA04000V0	RA04000E0	1/8	3.8	1/8	1	1.46	0.69	0.63	37	17.5	16	0.10	45	
RA0401000	RA04010V0	RA04010E0	1/4	5.7	1/4	1	1.97	0.83	0.75	50	21	19	0.18	80	
RA0402000	RA04020V0	RA04020E0	3/8	7.6	3/8	1	2.36	0.98	0.90	60	25	23	0.29	130	
RA0403000	RA04030V0	RA04030E0	1/2	10.3	1/2	1	2.75	1.15	1.06	70	29.2	27	0.44	200	
RA0404000	RA04040V0	RA04040E0	3/4	14.2	3/4	1	3.38	1.50	1.38	86	38	35	0.93	420	
RA0405000	RA04050V0	RA04050E0	1	16.5	1	1	3.94	1.77	1.61	100	45	41	1.41	640	
--	RA04060V0	RA04060E0	1 1/4	20.5	1 1/4	1	5.12	2.40	2.16	130	61	55	3.46	1570	
--	RA04070V0	RA04070E0	1 1/2	25.8	1 1/2	1	5.31	2.83	2.56	135	72	65	5.16	2340	
--	RA04090V0	RA04090E0	2	34.7	2	1	5.90	3.30	2.95***	150	84	75***	6.57	2980	

*Body size 1 1/4, 1 1/2 and 2 are supplied with FKM seals as a standard.

**Alternative end connections available upon request. depending on size (please contact Danfoss technical support).

***Across flat dimension.

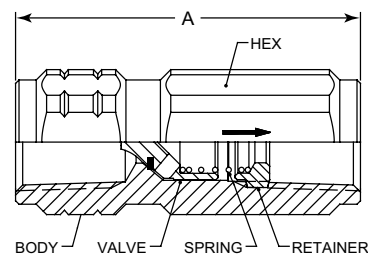

Figure 2

Cracking Pressure 0.5 bar (7.25 psi)

Part Number	Size	Thread NPTF	Fig.	Dimensions A	Hex	Rated Pressure
NBR*	(in)			(in)	(in)	psi
RA0421000	1/4	1/4-18	2	1.97	0.75	10,150
RA0422000	3/8	3/8-18	2	2.36	0.91	10,150
RA0423000	1/2	1/2-14	2	2.76	1.06	7,250
RA0424000	3/4	3/4-14	2	3.39	1.38	7,250
RA0425000	1	1-11 1/2	2	3.94	1.62	7,250
RA0429V0*	2	2-11 1/2	2	5.91	2.95	4,350

*Supplied with FKM seal.

Cracking Pressure 1 bar (14.5 psi)

Part Number			Body Size (in)	Nominal Flow Diameter (mm)	Thread Size** (Female)	BSPP	Fig.	Dimensions						Weight	
NBR*	FKM	EPDM						A (in)	B (in)	Hex (in)	A (mm)	B (mm)	Hex (mm)	lbs	grams
RA040000B	RA04000VB	RA04000EB	1/8	3.8	1/8	1	1.46	0.69	0.63	37	17.5	16	0.10	45	
RA040100B	RA04010VB	RA04010EB	1/4	5.7	1/4	1	1.97	0.83	0.75	50	21	19	0.18	80	
RA040200B	RA04020VB	RA04020EB	3/8	7.6	3/8	1	2.36	0.98	0.90	60	25	23	0.29	130	
RA040300B	RA04030VB	RA04030EB	1/2	10.3	1/2	1	2.75	1.15	1.06	70	29.2	27	0.44	200	
RA040400B	RA04040VB	RA04040EB	3/4	14.2	3/4	1	3.38	1.50	1.38	86	38	35	0.93	420	
RA040500B	RA04050VB	RA04050EB	1	16.5	1	1	3.94	1.77	1.61	100	45	41	1.41	640	
--	RA04060VB	RA04060EB	1 1/4	20.5	1 1/4	1	5.12	2.40	2.16	130	61	55	3.46	1570	
--	RA04070VB	RA04070EB	1 1/2	25.8	1 1/2	1	5.31	2.83	2.56	135	72	65	5.16	2340	
--	RA04090VB	RA04090EB	2	34.7	2	1	5.90	3.30	2.95***	150	84	75***	6.57	2980	

*Body size 1 1/4, 1 1/2 and 2 are supplied with FKM seals as a standard.

**Alternative end connections available upon request. depending on size (please contact Danfoss technical support).

***Across flat dimension.

R4000 Series

(Brass)

Check valves

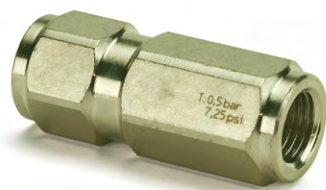

The Danfoss Hansen R4000 Series brass check-valves are designed to either allow flow of fluid in one direction only or limit the line's internal pressure to the cracking pressure. Standard cracking pressures are 0.5 and 1 bar (7.25 and 14.5 psi). Alternatives can be offered upon request. It is designed to handle liquids in all industries and for fluid transfer lines.

Product Features

- Standard body material: Nickel-plated brass
- Standard seal material: NBR, FKM, EPDM

Operating Guidelines

The Danfoss R4000 series is designed to handle liquids. Should applications involving gases (but not unstable gases) be considered, the user should certify that sonic frequencies will not exceed 1 Hz (one cycle per second). For further information, please contact Danfoss technical support.

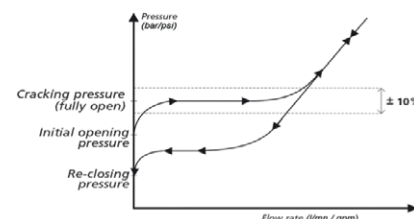

European Pressure Equipment Directive

All check valves are designed and manufactured under Article 4.3 of the European Pressure Equipment Directive PED 2014/68/EU. Check valves with nominal diameters greater than 25 mm should not be used to convey gases in Group 1 (hazardous). Working pressures for liquids of Group 1 (hazardous) and gases of Group 2 (non-hazardous) are reduced. Please refer to "Physical Characteristics" table. Our series R4000 check valves must not be used as safety devices (as per PED 2014/68/EU).

Physical Characteristics

Body Size (in)	Nominal Flow Diameter (mm)	Max. Operating Pressure**					
		Non hazardous liquids		Hazardous liquids & Non-Hazardous Gases Flow*		Rated	
		bar	(psi)	bar	(psi)	L/min	(gpm)
1/8	3.8	400	5,800	400	5,800	4.5	1.19
1/4	5.7	400	5,800	400	5,800	14.2	3.75
3/8	7.6	400	5,800	400	5,800	22	5.81
1/2	10.3	250	3,625	250	3,625	32	8.45
3/4	14.2	250	3,625	250	3,625	72	19
1	16.5	250	3,625	250	3,625	117	30.9
1 1/4	20.5	150	2,175	150	2,175	188	49.66
1 1/2	25.8	150	2,175	75	1,085	232	61.29
2	34.7	100	1,450	25	360	393	103.81

*Indicated values refer to a 1 bar/14.5 psi pressure drop.

**Group 1 = Hazardous media / Group 2 = Other media

Applications & Markets

- All Industries
- Agriculture
- Construction
- Fluid Transfer Lines

Flow Data

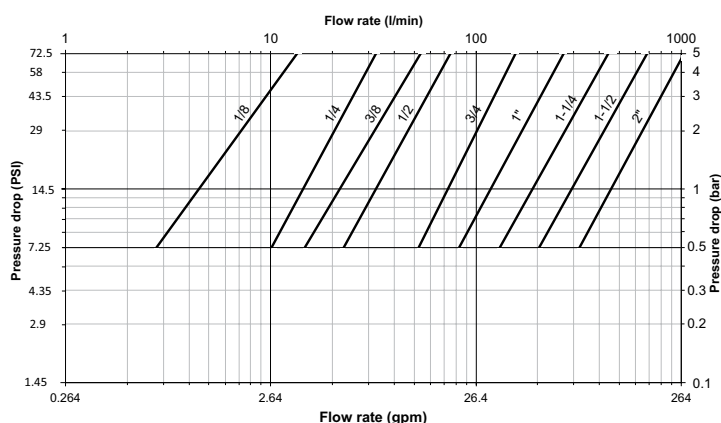

Applicable to valves with 0.5 bar (7.25 psi) cracking pressure

Seal Elastomer Data*	
Seal Elastomer	Max. Operation Temperature Range
NBR (Nitrile)	-20°C +100°C / -4°F +212°F
FKM (Fluorocarbon)	-20°C +200°C / -4°F +392°F
EPDM (Ethylene-Propylene)**	-40°C +150°C / -40°F +302°F

*For reference only, based on Danfoss recommended temperatures.

**In accordance with NF L 17-241 or NAS 1613 rev. 5

Contact Danfoss technical support for further information on fluid compatibility.

R4000 Series (Brass)

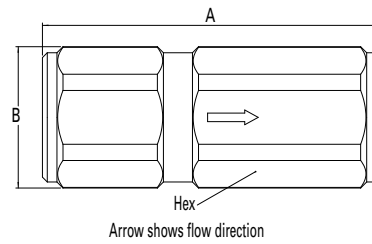

Figure 1

Cracking Pressure 0.5 bar (7.25 psi)

Part Number			Body Size (in)	Nominal Flow Diameter (mm)	Thread Size** (Female) BSP	Fig.	Dimensions						Weight	
NBR*	FKM	EPDM					A (in)	B (in)	Hex (in)	A (mm)	B (mm)	Hex (mm)	lbs	grams
RL0400000	RL04000V0	RL04000E0	1/8	3.8	1/8	1	1.46	0.69	0.63	37	17.5	16	0.11	50
RL0401000	RL04010V0	RL04010E0	1/4	5.7	1/4	1	1.97	0.83	0.75	50	21	19	0.19	85
RL0402000	RL04020V0	RL04020E0	3/8	7.6	3/8	1	2.36	0.98	0.9	60	25	23	0.31	140
RL0403000	RL04030V0	RL04030E0	1/2	10.3	1/2	1	2.75	1.15	1.06	70	29.2	27	0.47	215
RL0404000	RL04040V0	RL04040E0	3/4	14.2	3/4	1	3.38	1.50	1.38	86	38	35	1.01	460
RL0405000	RL04050V0	RL04050E0	1	16.5	1	1	3.94	1.77	1.61	100	45	41	1.52	690
-	RL04060V0	RL04060E0	1 1/4	20.5	1 1/4	1	5.12	2.40	2.16	130	61	55	3.73	1690
-	RL04070V0	RL04070E0	1 1/2	25.8	1 1/2	1	5.31	2.83	2.56	135	72	65	5.71	2590
-	RL04090V0	RL04090E0	2	34.7	2	1	5.90	3.30	2.95***	150	84	75***	7.50	3400

*Body sizes 1/4, 1/2 and 2 are supplied with FKM seals as a standard.

**Alternative end connections available upon request, depending on size (please contact Danfoss technical support).

***Across flat dimension.

Cracking Pressure 1 bar (14.5 psi)

Part Number			Body Size (in)	Nominal Flow Diameter (mm)	Thread Size** (Female) BSP	Fig.	Dimensions						Weight	
NBR*	FKM	EPDM					A (in)	B (in)	Hex (in)	A (mm)	B (mm)	Hex (mm)	lbs	grams
RL040000B	RL04000VB	RL04000EB	1/8	3.8	1/8	1	1.46	0.69	0.63	37	17.5	16	0.11	50
RL040100B	RL04010VB	RL04010EB	1/4	5.7	1/4	1	1.97	0.83	0.75	50	21	19	0.19	85
RL040200B	RL04020VB	RL04020EB	3/8	7.6	3/8	1	2.36	0.98	0.90	60	25	23	0.31	140
RL040300B	RL04030VB	RL04030EB	1/2	10.3	1/2	1	2.75	1.15	1.06	70	29.2	27	0.47	215
RL040400B	RL04040VB	RL04040EB	3/4	14.2	3/4	1	3.38	1.50	1.38	86	38	35	1.01	460
RL040500B	RL04050VB	RL04050EB	1	16.5	1	1	3.94	1.77	1.61	100	45	41	1.52	690
-	RL04060VB	RL04060EB	1 1/4	20.5	1 1/4	1	5.12	2.40	2.16	130	61	55	3.73	1690
-	RL04070VB	RL04070EB	1 1/2	25.8	1 1/2	1	5.31	2.83	2.56	135	72	65	5.71	2590
-	RL04090VB	RL04090EB	2	34.7	2	1	5.90	3.30	2.95***	150	84	75***	7.50	3400

*Body sizes 1/4, 1/2 and 2 are supplied with FKM seals as a standard.

**Alternative end connections available upon request, depending on size (please contact Danfoss technical support).

***Across flat dimension.

R4000 Series (Stainless Steel)

Check valves



The Danfoss Hansen R4000 Series stainless steel check valves are designed to either allow flow of fluid in one direction only or limit the line's internal pressure to the cracking pressure. Standard cracking pressures are 0.5 and 1 bar (7.25 and 14.5 psi). Alternatives can be offered upon request. It is designed to handle liquids in all industries and for fluid transfer lines. The material used offers excellent corrosion resistance.

Product Features

- Standard body material: AISI 316L Stainless steel
- Standard seal material: FKM, EPDM

Operating Guidelines

The Danfoss R4000 series is designed to handle liquids. Should applications involving gases (but not unstable gases) be considered, the user should certify that sonic frequencies will not exceed 1 Hz (one cycle per second). For further information, please contact Danfoss technical support.

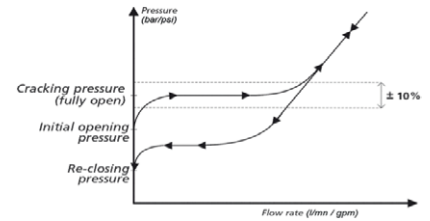

European Pressure Equipment Directive

Check valves with nominal diameters up to and including 25 mm are designed and manufactured under Article 4.3 of the European Pressure Equipment Directive PED 2014/68/EU. Check valves with nominal diameters greater than 25 mm are designed and manufactured in accordance with the stipulations of Module A of the European Pressure Equipment Directive PED 2014/68/EU. They should not be used to convey unstable gases. Our series R4000 check valves must not be used as safety devices (as per PED 2014/68/EU).

Physical Characteristics

Max. Operating Pressure**							
Body Size	Nominal Flow Diameter	Non hazardous liquids & gases Group 2		Hazardous liquids & gases Group 1		Rated Flow*	
		(bar)	(psi)	(bar)	(psi)	L/min	(gpm)
1/8	3.8	400	5,800	400	5,800	4.5	1.19
1/4	5.7	400	5,800	400	5,800	14.2	3.75
3/8	7.6	400	5,800	400	5,800	22	5.81
1/2	10.3	250	3,625	250	3,625	32	8.45
3/4	14.2	250	3,625	250	3,625	72	19.00
1	16.5	250	3,625	250	3,625	117	30.90
1 1/4	20.5	150	2,175	150	2,175	188	49.66
1 1/2	25.8	150	2,175	38	550	232	61.29
2	34.7	100	1,450	28	405	393	103.81

*Indicated values refer to a 1 bar / 14.5 psi pressure drop.

**Group 1 = Hazardous media / Group 2 = Other media

Applications & Markets

- All Industries
- Agriculture
- Construction
- Fluid Transfer Lines

Flow Data

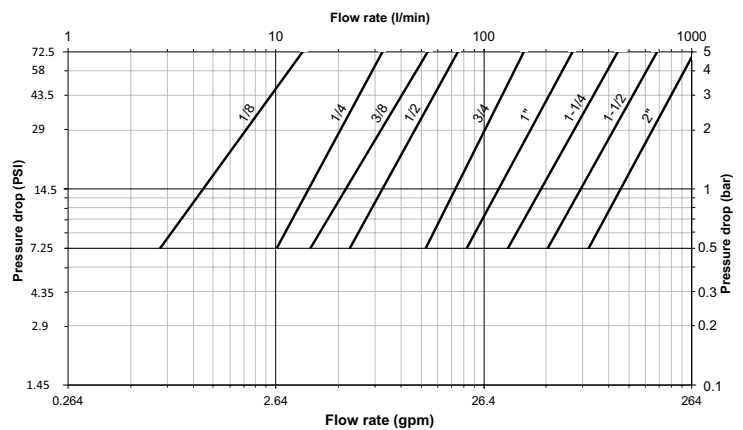

Applicable to valves with 0.5 bar (7.25 psi) cracking pressure

Seal Elastomer Data*

Seal Elastomer	Max. Operation Temperature Range
FKM (Fluorocarbon)*	-20°C +200°C / -4°F +392°F
EPDM (Ethylene-Propylene)**	-40°C +150°C / -40°F +302°F

*For reference only, based on Danfoss recommended temperatures.

**In accordance with NF L 17-241 or NAS 1613 rev. 5

Contact Danfoss technical support for further information on fluid compatibility.

R4000 Series

(Stainless Steel)

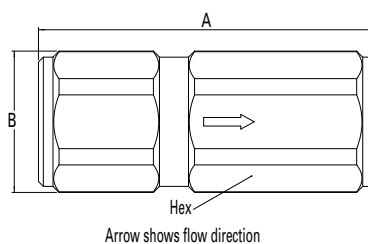

Figure 1

Cracking Pressure 0.5 bar (7 psi)

Part Number	FKM	EPDM	Body Size (in)	Nominal Flow Diameter (mm)	Thread Size* (Female)	BSP	Fig.	Dimensions			Weight		
								A (in)	B (in)	Hex (in)	A (mm)	B (mm)	Hex (mm)
RZ04000V0	RZ04000E0	1/8	3.8	1/8	1	1.46	0.69	0.63	37	17.5	16	0.10	45
RZ04010V0	RZ04010E0	1/4	5.7	1/4	1	1.97	0.83	0.75	50	21	19	0.18	80
RZ04020V0	RZ04020E0	3/8	7.6	3/8	1	2.36	0.98	0.90	60	25	23	0.29	130
RZ04030V0	RZ04030E0	1/2	10.3	1/2	1	2.75	1.15	1.06	70	29.2	27	0.44	200
RZ04040V0	RZ04040E0	3/4	14.2	3/4	1	3.38	1.50	1.38	86	38	35	0.93	420
RZ04050V0	RZ04050E0	1	16.5	1	1	3.94	1.77	1.61	100	45	41	1.41	640
RZ04060V0	RZ04060E0	1 1/4	20.5	1 1/4	1	5.12	2.40	2.16	130	61	55	3.46	1570
RZ04070V0	RZ04070E0	1 1/2	25.8	1 1/2	1	5.31	2.83	2.56	135	72	65	5.16	2340
RZ04090V0	RZ04090E0	2	34.7	2	1	5.90	3.30	2.95**	150	84	75**	6.57	2980

*Alternative end connections available upon request, depending on size (please contact Danfoss technical support).

**Across flat dimension.

Cracking Pressure 1 bar (14.5 psi)

Part Number	FKM	EPDM	Body Size (in)	Nominal Flow Diameter (mm)	Thread Size* (Female)	BSP	Fig.	Dimensions			Weight		
								A (in)	B (in)	Hex (in)	A (mm)	B (mm)	Hex (mm)
RZ04000VB	RZ04000EB	1/8	3.8	1/8	1	1.46	0.69	0.63	37	17.5	16	0.10	45
RZ04010VB	RZ04010EB	1/4	5.7	1/4	1	1.97	0.83	0.75	50	21	19	0.18	80
RZ04020VB	RZ04020EB	3/8	7.6	3/8	1	2.36	0.98	0.90	60	25	23	0.29	130
RZ04030VB	RZ04030EB	1/2	10.3	1/2	1	2.75	1.15	1.06	70	29.2	27	0.44	200
RZ04040VB	RZ04040EB	3/4	14.2	3/4	1	3.38	1.50	1.38	86	38	35	0.93	420
RZ04050VB	RZ04050EB	1	16.5	1	1	3.94	1.77	1.61	100	45	41	1.41	640
RZ04060VB	RZ04060EB	1 1/4	20.5	1 1/4	1	5.12	2.40	2.16	130	61	55	3.46	1570
RZ04070VB	RZ04070EB	1 1/2	25.8	1 1/2	1	5.31	2.83	2.56	135	72	65	5.16	2340
RZ04090VB	RZ04090EB	2	34.7	2	1	5.90	3.30	2.95**	150	84	75**	6.57	2980

*Alternative end connections available upon request depending on size (please contact Danfoss technical support).

**Across flat dimension.

Couplings for diagnostic applications

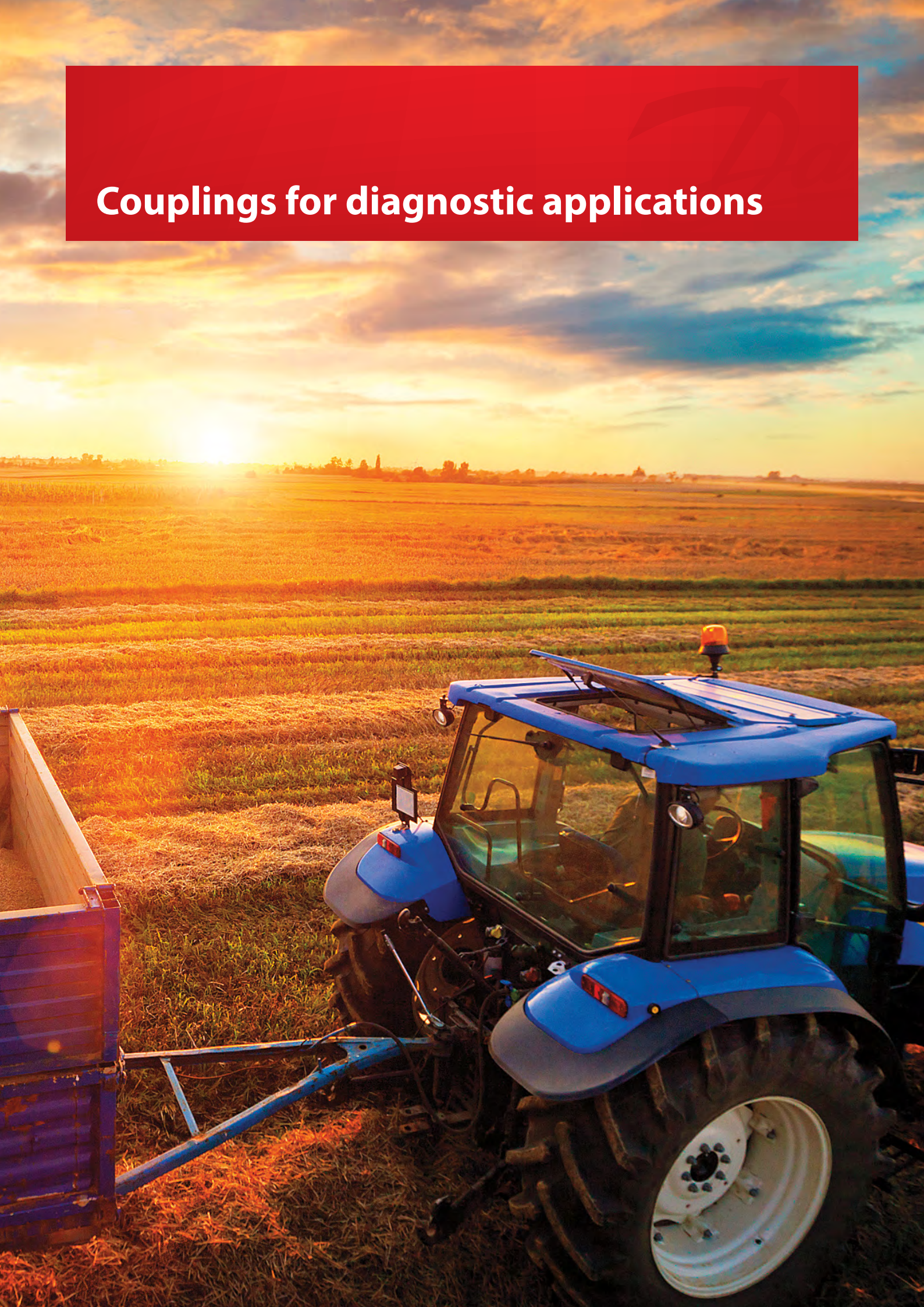

Table of Contents

Screw to connect

FD15 Series.....	126
FD90 Series.....	128
FF14802 pressure gauge kit Series.....	130
FS Flow sensor Series.....	132

FD15 Series

Oil Sampling Valve

Diagnostic



Danfoss Hansen FD15 Series Oil Sampling Valve is designed for in-line sampling of system fluids without system shutdown, usually in less than one minute, and without fluid contamination.

Product Features

- Standard seal material: Nitrile (NBR)
- Corrosion resistant plated steel with brass internal components
- Operating Temperature Range: -65°F to +275°F (-53°C to +135°C)
- Minimum Burst Pressure: 12,000 psi
- Minimum Particle Restriction: 500 microns
- Maximum Torque to Operate: 10 in. lbs.

- FD15-1000-04 is qualified to the MIL-V-81940/2-1
- Note: This valve is not intended for aerospace applications.

Applications & Markets

- Engine oil
- Lubricating oil
- Transmission fluid and hydraulic fluids in mobile construction equipment, military vehicles, trucks and stationary equipment

Operation

- For best results, Danfoss FD15 Oil Sampling Valves should be installed in dynamic fluid lines in low pressure and return lines. If only one sampling point can be chosen, it should be in the return line, upstream of any return line filter. This will insure a representative sample of all components in the fluid system for their present condition.

Instructions

1. Remove metal dustcover on discharge port.
2. Discharge approximately 200 ml of oil to flush valve by turning knurled knob ¼ turn to the right. Dispose of this sample in the appropriate manner.
3. Locate clean oil sample bottle under discharge port. (Sample bottles are usually supplied by the oil analysis lab.)
4. Turn knurled knob ¼ turn to the right until bottle is filled to the desired level. The knob can be backed off to throttle the rate of flow.
5. When bottle is filled let go of the knurled knob, the valve will close automatically. Replace metal dustcover wrench tight.

Notes

As required in MIL-V-81940/2-1 this valve's flow rate is between 100 and 1500 milliliters per minute at pressures from 0–50 psi. (MIL-V-81940/2-1 applies only to pressures from 50–300 psi.)

The ¼" NPTF version is qualified to MIL-V-81940/2-1 and its performance is representative of the other inlet port configurations listed above. QPL-81940-9 6-5-89

FD15 Series

Oil Sampling Valve

**Male Pipe Thread
50-300 psi**

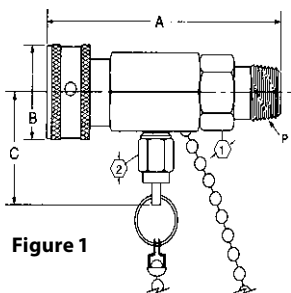

Figure 1

**Male SAE O-Ring Thread
50-300 psi**

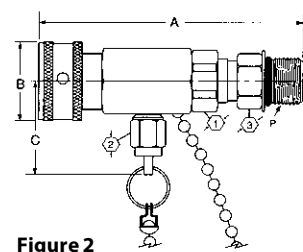

Figure 2

Dimensions (Male Pipe Thread)

Part Number NBR	Sampling Type	Port Size	Thread	Type	Fig.	Dimensions						
						A	B	C	Hex ①	Hex ②	Hex ③	
						mm (in)	mm (in)	mm (in)	mm (in)	mm (in)	mm (in)	
FD15-1000-02	50-300 psi	1/8	1/8-27	Male Pipe Thread	1	61.5 (2.42)	25.4 (1.00)	33.0 (1.30)	17.5 (.69)	9.7 (.38)	-	-
FD15-1000-04	50-300 psi	1/4	1/4-18	Male Pipe Thread	1	65.0 (2.56)	25.4 (1.00)	33.0 (1.30)	17.5 (.69)	9.7 (.38)	-	-

Dimensions (Male SAE O-Ring Thread)

Part Number NBR	Sampling Type	Port Size	Thread	Type	Fig.	Dimensions						
						A	B	C	Hex ①	Hex ②	Hex ③	
						mm (in)	mm (in)	mm (in)	mm (in)	mm (in)	mm (in)	
FD15-1002-04	50-300 psi	7/16	7/16-20	Male SAE O-Ring Thread	2	70.9 (2.79)	25.4 (1.00)	33.0 (1.30)	17.5 (.69)	9.7 (.38)	14.2 (.56)	

Dimensions (Male Pipe Thread)

Part Number NBR	Sampling Type	Port Size	Thread	Type	Fig.	Dimensions						
						A	B	C	Hex ①	Hex ②	Hex ③	
						mm (in)	mm (in)	mm (in)	mm (in)	mm (in)	mm (in)	
FD15-1026-04	0-50 psi	1/4	1/4-18	Male Pipe Thread	3	65.0 (2.56)	25.4 (1.00)	33.0 (1.30)	17.5 (.69)	9.7 (.38)	-	-

Dimensions (Male SAE O-Ring Thread)

Part Number NBR	Sampling Type	Port Size	Thread	Type	Fig.	Dimensions						
						A	B	C	Hex ①	Hex ②	Hex ③	
						mm (in)	mm (in)	mm (in)	mm (in)	mm (in)	mm (in)	
FD15-1025-04	0-50 psi	7/16	7/16-20	Male SAE O-Ring Thread	4	70.9 (2.79)	25.4 (1.00)	33.0 (1.30)	17.5 (.69)	9.7 (.38)	14.2 (.56)	

**Male Pipe Thread
0-50 psi**

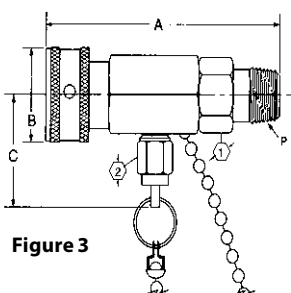

Figure 3

**Male SAE O-Ring Thread
0-50 psi**

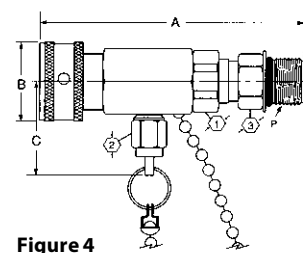

Figure 4

FD90 Series

Diagnostic Coupling

SAE J1502 Interchange

Diagnostic



Danfoss Hansen FD90 Series diagnostic coupling is designed to connect and disconnect pressure gauges to hydraulic systems, eliminating the need for permanent gauges. The maximum operating pressure is 7,000 psi.

Product Features

- Automatic sleeve for one hand push-to-connect operation
- Flush face valving provides minimal fluid loss and low air inclusion
- Self-sealing valve design allows connection and disconnection at 500 psi
- Broad range of end configurations for system accessibility
- Standard seal material: Nitrile (NBR)
- Standard Body Material: High resistance carbon steel with Zinc trivalent plating
- Diagnostic pressure testing for hydraulic systems

Physical Characteristics

Coupling Body Size (in)	Max. Operating Pressure Connected		Min. Burst Pressure Connected Only		Vacuum (in./Hg)	Rated Flow		Air Inclusion cc. max.	Fluid Loss cc.max.
	(bar)	(psi)	(bar)	(psi)		(lpm)	(gpm)		
¼	483	7,000	1,931	28,000	28	1.89	0.6	0.02	0.10

Dimensions (Female Pipe, Valved)

Part Number (NBR)	Part Number with Dust Cap (NBR)	Coupling Type	Body Size	Port Size	Thread	Type	Fig.	Dimensions					
								A		B		Hex ^①	
								mm	(in)	mm	(in)	mm	(in)
FD90-1034-02-04	FD90-1035-02-04	Plug/Male	¼	⅜	⅜ - 27	Female NPT	1	43.2	(1.70)	-	-	15.7	(0.62)
FD90-1021-02-04	—	Socket/Female	¼	⅜	⅜ - 27	Female NPT	2	49.5	(1.95)	25.4	(1.00)	19.1	(0.75)
FD90-1034-04-04	FD90-1035-04-04	Plug/Male	¼	¼	¼ - 18	Female NPT	1	48.3	(1.90)	-	-	19.1	(0.75)
FD90-1021-04-04	—	Socket/Female	¼	¼	¼ - 18	Female NPT	2	57.2	(2.25)	25.4	(1.00)	19.1	(0.75)

Dimensions (Male SAE O-Ring, Valved)

Part Number (NBR)	Part Number with Dust Cap (NBR)	Coupling Type	Body Size	Port Size	Thread	Type	Fig.	Dimensions					
								A		B		Hex ^①	
								mm	(in)	mm	(in)	mm	(in)
FD90-1044-03-04	FD90-1004-03-04	Plug/Male	¼	⅜	⅜ - 24	Male SAE O-Ring	3	38.6	(1.52)	-	-	15.7	(0.62)
FD90-1044-04-04	FD90-1004-04-04	Plug/Male	¼	7/16	7/16 - 20	Male SAE O-Ring	3	40.1	(1.58)	-	-	15.7	(0.62)
FD90-1044-05-04	FD90-1004-05-04	Plug/Male	¼	½	½ - 20	Male SAE O-Ring	3	33.5	(1.32)	-	-	15.7	(0.62)
FD90-1044-06-04	FD90-1004-06-04	Plug/Male	¼	9/16	9/16 - 18	Male SAE O-Ring	3	33.5	(1.32)	-	-	17.5	(0.69)

Dimensions (Male Pipe, Valved)

Part Number (NBR)	Part Number with Dust Cap (NBR)	Coupling Type	Body Size	Port Size	Thread	Type	Fig.	Dimensions					
								A		B		Hex ^①	
								mm	(in)	mm	(in)	mm	(in)
FD90-1012-02-04	FD90-1045-02-04	Plug/Male	¼	⅜	⅜ - 27	Male NPT	4	40.6	(1.60)	-	-	15.7	(0.62)
FD90-1012-04-04	FD90-1045-04-04	Plug/Male	¼	¼	¼ - 18	Male NPT	4	37.8	(1.49)	-	-	17.5	(0.69)

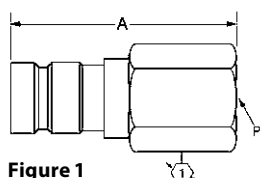

Figure 1

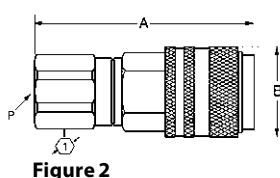

Figure 2

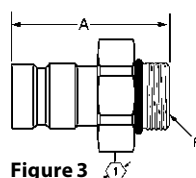

Figure 3

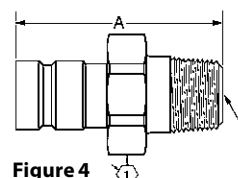

Figure 4

FD90 Series

Diagnostic Coupling SAE J1502 Interchange

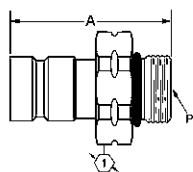

Figure 5

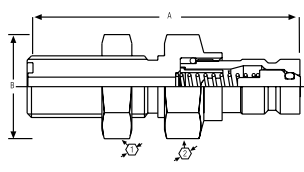

Figure 6

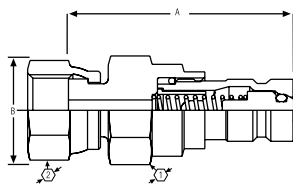

Figure 7

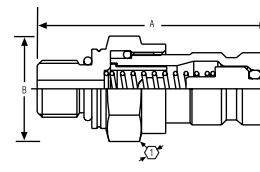

Figure 8

Dimensions (Metric Male O-Ring, Valved)

Part Number (NBR)	Part Number with Dust Cap (NBR)	Coupling Type	Body Size	Port Size	Thread	Type	Fig.	Dimensions A		Dimensions B		Hex ①	
								mm	(in)	mm	(in)	mm	(in)
FD90-1046-06-04	FD90-1047-06-04	Plug/Male	¼	M14	M14x1.5	Male O-Ring	5	38.5	(1.52)	-	-	19.1	(0.75)

Dimensions (Female SAE O-Ring, Valved)

Part Number (NBR)	Coupling Type	Body Size	Port Size	Thread	Type	Fig.	Dimensions A		Dimensions B		Hex ①	
							mm	(in)	mm	(in)	mm	(in)
FD90-1041-04-04	Socket/Female	¼	7/16	7/16 - 20	Female SAE O-Ring	2	55.9	(2.20)	25.40	(1.00)	19.1	(0.75)

Dimensions (Male ORS Bulkhead, Valved)

Part Number (NBR)	Coupling Type	Body Size	Port Size	Thread	Type	Fig.	Dimensions A		Dimensions B		Hex ①	
							mm	(in)	mm	(in)	mm	(in)
FD90-1206-04-04	Plug/Male	¼	9/16	9/16 - 18	Male ORS Bulkhead	6	62.5	(2.46)	20.6	(0.81)	20.6	(0.81)

Dimensions (Male ORS Bulkhead, Valved)

Part Number (NBR)	Coupling Type	Body Size	Port Size	Thread	Type	Fig.	Dimensions A		Dimensions B		Hex ①	
							mm	(in)	mm	(in)	mm	(in)
FD90-1061-04-04	Plug/Male	¼	9/16	9/16 - 18	Female ORS Swivel	7	46.5	(1.79)	22.1	(0.87)	17.5	(0.69)
FD90-1061-06-04	Plug/Male	¼	11/16	11/16 - 16	Female ORS Swivel	7	46.5	(1.83)	23.9	(0.94)	20.6	(0.81)
FD90-1061-08-04	Plug/Male	¼	13/16	13/16 - 16	Female ORS Swivel	7	49.0	(1.93)	27.4	(1.08)	23.9	(0.94)

Dimensions (Male Metric O-Ring, Valved)

Part Number (NBR)	Coupling Type	Body Size	Port Size	Thread	Type	Fig.	Dimensions A		Dimensions B		Hex ①	
							mm	(in)	mm	(in)	mm	(in)
FD90-1090-10-04	Plug/Male	¼	M10	M10x1	Metric O-Ring	8	40.1	(1.58)	18.3	(0.72)	-	-

Dust Cap for Plug/Male Halves

Body Size	Part Number
¼	FD90-1040-04



Dust Cap for
Plug/Male Halves

Pressure Gauge Kit

FF14802

Diagnostic



Danfoss' Pressure Gauge Kit and screw together test couplings provide accurate and efficient pressure control and monitoring of your hydraulic system, while minimizing the introduction of contamination. The complete kit is pre-packaged with Danfoss' most common adapters and test couplings.

Product Features

- Test system at working pressure
- 630 bar (9,000 psi) working pressure
- 345 bar (5,000 psi) connect under pressure
- Accurate pressure control and system monitoring
- Leak-free connection before piston valve opens

- Simple and fast screw together connections
- Self-locking caps

Applications & Markets

- Hydraulics and mineral based fluids
- Agricultural equipment
- Construction equipment
- On-Highway vehicles
- Industrial equipment

Couplings/Adapters

- Standard body material: Zinc Nickel Plated Steel
- Standard seal material: FKM
- 345 bar (5,000 psi) connect under pressure
- 630 bar (9,000 psi) working pressure

Hose Assemblies

- 630 bar (9,000 psi) working pressure
- 20mm (.75") bend radius
- Nominal Bore 2mm (.08")
- Hose cover/core – PA 11/12
- Reinforcement – synthetic fiber

Gauges

- Polished Brass Casing
- Glycerine Filled
- Dual Scales
- Relief Valve
- Acrylic Lens

Pressure Gauge Kit

Complete Kit Number	Component Part Number	Description	Quantity Per Kit
FF14802	FF14783	1/8"NPT Test Coupling	2
	FF14784	1/4"NPT Test Coupling	2
	FF14787	7/16-20 UNF Test Coupling	1
	FF14788	9/16-18 UNF Test Coupling	1
	FF14794	1/4"NPT Gauge Adapter	3

Complete Kit Number	Component Part Number	Description	Quantity Per Kit
	FF14796	Union Adapter	2
	FF14798	60" Test Hose Assembly	2
	FF14799	(-) 30 in/Hg - 30 psi Gauge	1
	FF14800	1,000 psi Gauge	1
	FF14801	7,500 psi Gauge	1

Dimensions (Standard Test Couplings)

Part Number	Thread	Dimensions		Hex ^①	Bag	Quantity*	
		A	B				
		mm	(in)	mm	(in)		
FF14783	1/8"NPT	45.0	(1.77)	20.0	(.79)	17.0 (.67)	4
FF14784	1/4"NPT	50.0	(1.97)	20.0	(.79)	17.0 (.67)	4
FF14785	M14	49.0	(1.93)	20.0	(.79)	19.0 (.75)	3
FF14786	M16	48.5	(1.91)	20.0	(.79)	22.0 (.87)	3
FF14787	7/16-20 UNF	47.0	(1.85)	20.0	(.79)	17.0 (.67)	4
FF14788	9/16-18 UNF	47.5	(1.87)	20.0	(.79)	19.0 (.75)	4

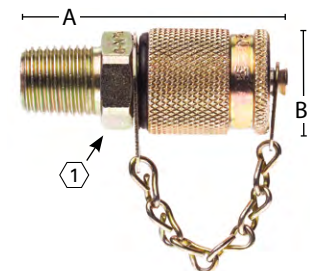

Standard Test Couplings

*When the indicated part number is ordered, the bag quantity is the number of pieces supplied. For example, if a quantity of one FF14792 is ordered, one bag containing two pieces will be delivered.

Dimensions (Bulkhead Couplings)

Part Number	Thread	Dimensions A				Hex ①		Hex ②		Bag Quantity*
		mm	(in)	mm	(in)	mm	(in)	mm	(in)	
FF14789	M16	72.0	(2.83)	20.0	(.79)	17.0	(.67)	19.0	(.75)	2

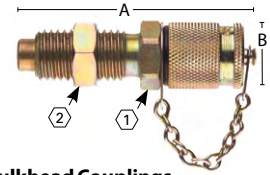

Bulkhead Couplings

Dimensions (Swivel Run Tee with Test Coupling)

Part Number	Thread #1	Thread #2	Dimensions A				Hex ①		Bag Quantity*
			mm	(in)	mm	(in)	mm	(in)	
FF14790	7/16-20 UNF	7/16-20 UNF	47.7	(1.88)	20.0	(.79)	27.0	(1.06)	2
FF14791	9/16-18 UNF	9/16-18 UNF	47.7	(1.88)	20.0	(.79)	27.0	(1.06)	2
FF14792	3/4-16 UNF	3/4-16 UNF	47.7	(1.88)	20.0	(.79)	27.0	(1.06)	2

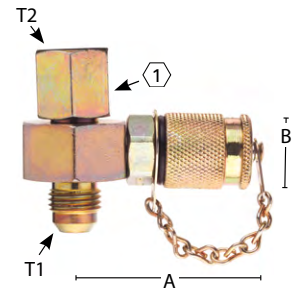

Swivel Run Tee with Test Coupling

Dimensions (Gauge Adapter)

Part Number	Thread #1	Thread #2	Dimensions A				Hex ①		Hex ②		Bag Quantity*
			mm	(in)	mm	(in)	mm	(in)	mm	(in)	
FF14793	1/4"NPT	M16	54.0	(2.13)	19.0	(.75)	19.0	(.75)	2		

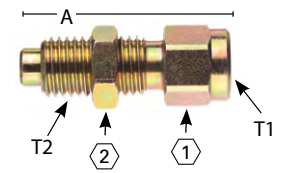

Gauge Adapter

Dimensions (Direct Gauge Adapter)

Part Number	Thread	Dimensions A				Hex ①		Bag Quantity*
		mm	(in)	mm	(in)	mm	(in)	
FF14794	1/4"NPT	40.5	(1.59)	20.0	(.79)	19.0	(.75)	2
FF14795	7/16-20 UNF	41.0	(1.61)	20.0	(.79)	19.0	(.75)	2

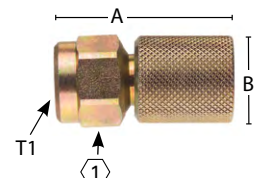

Direct Gauge Adapter

Dimensions (Union Adapter)

Part Number	Thread #1	Thread #2	Dimensions A				Hex ①		Bag Quantity*
			mm	(in)	mm	(in)	mm	(in)	
FF14796	M16	M16	42.5	(1.67)	17.0	(.67)	2		

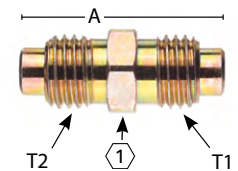

Union Adapter

Dimensions (Test Hose Assembly)

Part Number	Thread	Dimensions				Bag Quantity*
		Cut Length		Overall Length		
		mm	(in)	mm	(in)	
FF14797	M16	872.0	(34.33)	914.4	(36.00)	1
FF14798	M16	1482.0	(58.35)	1524.0	(60.00)	1



Test Hose Assembly

Dimensions (Gauges)

Part Number	Thread	Dimensions A				Rating	Bag Quantity*
		mm	(in)	mm	(in)		
FF14799	1/4"NPT	65.3	(2.57)	53.3	(2.10)	(-)30 in/Hg - 30 psi	1
FF14800	1/4"NPT	65.3	(2.57)	53.3	(2.10)	0 - 1,000 psi	1
FF14801	1/4"NPT	65.3	(2.57)	53.3	(2.10)	0 - 7,500 psi	1

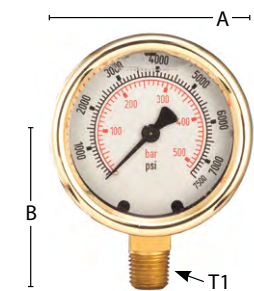

Gauges

FS Flow Sensor Series

Diagnostic

Danfoss' Flow Sensor Series is designed to protect personnel and property in case of hose failure in compliance with Federal Safety Regulations. Flow Sensors are intended for use with compressed air.



Product Features

- Automatically shuts off air flow to ruptured hose
- Automatically resets after failure correction
- Compact design, economical, tamper-resistant
- Reduces risk of injury or damage from hose whip
- Operates in any orientation
- Standard body material: Brass

Physical Characteristics

Size	Max. Operating Pressure		Min. Burst Pressure		Rated Flow	
	(bar)	(psi)	(bar)	(psi)	(lpm)	(gpm)
All Sizes	17	250	68	1,000	See Chart	See Chart

Applications & Markets

- General Industry
- Pneumatic Tools

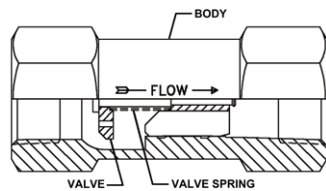
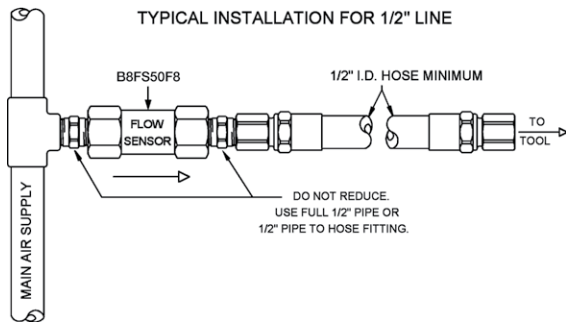

Flow Data

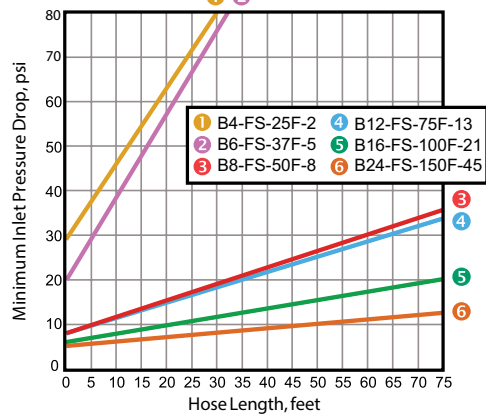

Flow Data: The graph above indicates the minimum inlet pressure for various hose lengths. Each Flow Sensor has a shut-off flow rating dependent upon inlet pressure. The length of hose and fitting size are critical in the proper operation of the valve. For example, with the B8FS50F8 Flow Sensor, the hose I.D. must be 1/2" using only 1/2" pipe thread end fittings. Thirty feet of hose requires at least 20 psig inlet pressure; fifty feet of hose requires at least 28 psig inlet pressure; and seventy-five feet of hose requires at least 36 psig inlet pressure. Inlet pressures lower than those indicated on the curves above will not guarantee protection in case of hose failure. Valve shut-off occurs only when flow exceeds the flow rating for the inlet pressure.

If hose lengths greater than 75 feet are required, a 1/2" size or larger Flow Sensor must be installed on the inlet end of each 75-foot section, and a correspondingly higher inlet pressure must be supplied for proper operation of the Flow Sensor to assure safety.

Part Number*	Body Size	Thread Size	Type	Shut-off Flow, SCFM, at Inlet Pressure, PSIG								Dimensions			
												Length	Hex	Length	Hex
				60	80	100	120	140	160	180	200	(in)	(in)	(mm)	(mm)
B4FS25F2	1/4	1/4-18	NPTF	16	18	20	22	23	25	26	27	2.14	0.75	54.36	19.05
B6FS37F5	3/8	3/8-18	NPTF	41	46	50	55	59	63	66	69	2.50	0.88	63.50	22.35
B8FS50F8	1/2	1/2-14	NPTF	65	73	80	87	93	99	104	109	3.12	1.06	79.25	26.92
B12FS75F13	3/4	3/4-14	NPTF	105	118	130	141	152	161	169	177	3.68	1.38	93.47	35.05
B16FS100F21	1	1-11 1/2	NPTF	170	191	210	227	245	260	273	286	4.59	1.75	116.59	44.45
B24FS150F45	1 1/2	1 1/2-11 1/2	NPTF	365	410	450	489	525	557	586	615	5.86	2.50	148.84	63.50

*All flow sensors have a pressure drop of approximately 2 psid at 80% of shut-off flow

Couplings for breathing air applications



Table of Contents

Screw to connect

FD17 Series.....	135
------------------	-----

Push to connect

Safe Breathe Series.....	136
--------------------------	-----

Ball latch

2500 Series.....	138
------------------	-----

FD17 Series

Breathing air application

The Danfoss Hansen FD17 high pressure coupling can be connected by hand while under pressure up to 5,500 psi/380 bar. This quick disconnect coupling is most commonly used in SCBA transfilling and buddy-breathing applications and is commonly found on SCBA equipment certified to various NIOSH, NFPA and CBRN standards.



Product Features

- Connect and disconnect under pressure up to 5,500 psi/380 bar
- Certified on SCBA equipment that meets NIOSH, NFPA and CBRN requirements
- Complies with NFPA 1981 and NFPA 2013
- Standard body material: Stainless steel, aluminum

Physical Characteristics

Series	Max. Operating Pressure		Min. Burst Pressure		Rated Flow*		Rated Temperature
	(bar)	(psi)	(bar)	(psi)	(lpm)	scfm	
FD17	380	5,500	1140	16,500	125	4.4	-40°F (-40°C)/+160°F (+71°C)

* Indicated value refer to a 1 bar/14.5 psi pressure drop.

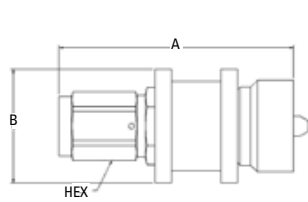

Figure 1

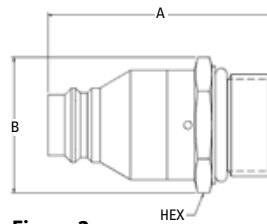

Figure 2

Part Number	Coupling Type	Body Size	Port Size	Thread	Type	Fig.	Dimensions			A	B	Hex
							A	B	Hex			
							(in)	(in)	(in)	(mm)	(mm)	(mm)
FD17-1003-04-04	Socket/Female	¼	-4	7/16-20	ORB	1	2.85	1.38	0.75	72.4	35.1	19.1
FD17-1082-10-04	Plug/Male	¼	-10	7/8-14	ORB	2	1.93	1.43	1	49.0	36.3	25.4



Male Dust Cap

Part Number

FD17-1064-04*

* Indicates patented product



Female Dust Cap

Part Number

FD17-1062-04

Safe Breathe Series

Breathing air application



Danfoss' Safe Breathe series is a coupling made for breathing air application with a specific profile: it is interchangeable with similar breathing air couplings available on the market. The locking-system is made with a push-button, and the connection is automatic. The coupling offers a working pressure of 10 bar.

The two-step disconnection avoids any handling mistake and guarantees the true safety effect. For the disconnection, in case the Danfoss plug would be used with a non-safety socket, the plug valve design has a slow pressure release that ensures by itself the safety function. The 6mm size has only one step operation for disconnection.

Product Features

- Available in sizes 6 mm, 8 mm and 11mm
- Color coded for a better identification and to avoid crossing lines
- Automatic connection
- Profile interchangeable with other series in the market
- Working pressure of 10 bar
- Safety feature to avoid accidental disconnection
- Push to connect locking-mechanism
- Optional safety chains available on size 11mm
- Standard body material: Stainless steel 316L
- Standard seal material: NBR
- Safety padlock can be added to avoid disconnecting

Application

- Breathing air application (industrial and chemical field)

Physical Characteristics

Body Size (mm)	Working Pressure		Nominal Flow Diameter (mm)	Plug part number	Socket part number	Thread		Profile certification
	(bar)	(psi)				Size	Type	
6	10	145	5,5	-	GZ1112638	3/8	BSPP	-
6	10	145	5,5	-	GZ1112612	1/2	BSPP	-
8	10	145	8	IC1119038	-	3/8	BSPP	-
8	10	145	8	IC1119012	-	1/2	BSPP	-
8	10	145	8	-	IZ1116013	1/2	BSPP	-
11	10	145	11	TC1111634	TZ1112134	3/4	BSPP	ISO 6150C

Flow Data

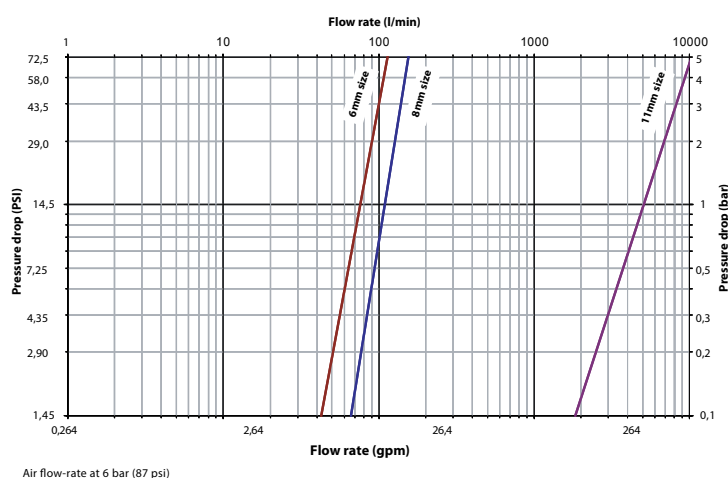

Safe Breathe Series

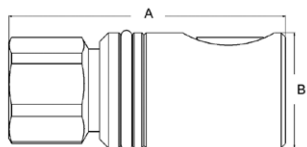

Figure 1

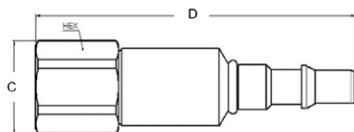

Figure 2

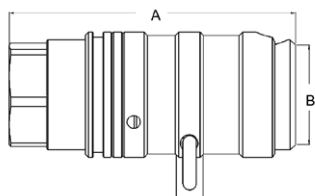

Figure 3

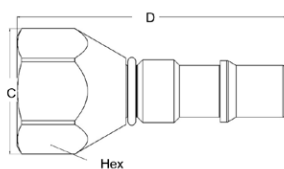

Figure 4

Dimensions

Part Number	Fig	Thread Size	Socket dimensions						Plug dimensions					Length connected (mm)	
		BSPP	A (mm)	B (mm)	Hex (mm)	A (in)	B (in)	Hex (in)	C (mm)	D (mm)	Hex (mm)	C (in)	D (in)		Hex (in)
GZ1112638	1	3/8	64,5	25,7	22	2,53	1,01	0,86	-	-	-	-	-	-	-
GZ1112612	1	1/2	66,5	25,7	27	2,61	1,01	1,06	-	-	-	-	-	-	-
IC1119012	2	1/2	-	-	-	-	-	-	24	98,5	Hex: 22	0,94	3,8	0,86	-
IC1119038	2	3/8	-	-	-	-	-	-	29,5	102	Hex: 27	1,16	4,01	1,06	-
TZ1112134	3	3/4	107,5	48,5	38	4,23	1,90	1,49	-	-	-	-	-	-	140
TC1111634	4	3/4	-	-	-	-	-	-	34	73	2 flats: 30	1,33	2,87	2 flats: 1,18	140

2500 Series

Breathing air application



Danfoss Hansen 2500 series is an aluminium ball latch coupling for breathing air application. Its anti-disconnection safety device eliminates the risk of accidental disconnection. The non-screwed adapter design avoids unscrewing of the adapter and hose-kicking also when the coupling is used with hoses. This coupling is available in size 1/4".

Product Features

- Anti-disconnection safety device
- Non-screwed adapter
- Size available in 1/4"
- Working pressure of 10 bar.

Application

- Breathing air application

Dimensions

Body Size (in)	Max. operating Pressure		Nominal Flow Diameter (mm)	Socket part number	Plug part number	Socket dimensions (Fig. 1)			Plug dimensions (Fig. 2)						Length connected (mm)			
	(bar)	(psi)				A (mm)	B (mm)	C (mm)	A (in)	B (in)	C (in)	D (mm)	E (mm)	F (mm)		D (in)	E (in)	F (in)
1/4	10	145	7,4	2500S37H	LL2500P37H	106,45	12,5	20,8	4,19	0,49	0,81	81,2	12,5	10,4	3,19	0,49	0,12	187,6

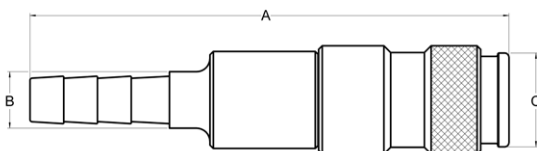

Figure 1 : Socket part

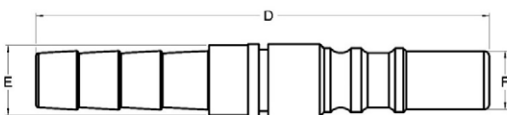
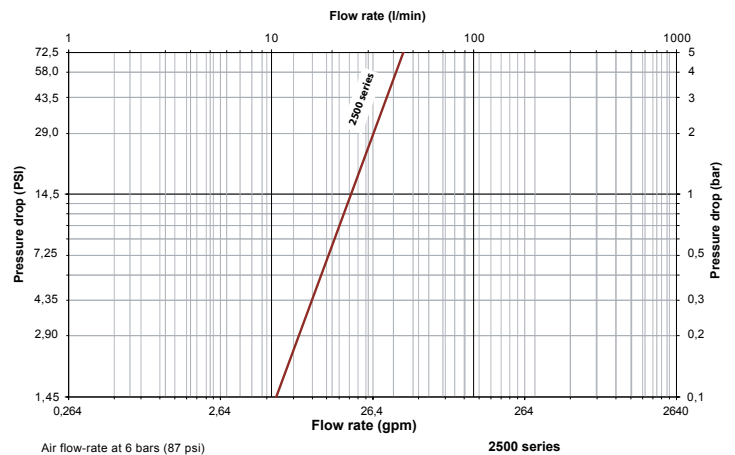

Figure 2 : Plug part

Flow Data



Couplings for thermal management application



Table of Contents

Flat face

ADB Series.....	141
-----------------	-----

Bajonette

FD83 Series.....	143
------------------	-----

Push to connect

UQD Series.....	145
-----------------	-----

Thread to connect

Flo-Temp Series.....	147
----------------------	-----

ADB Series (Aluminium)

Flat Face/Dry Break

Thermal Management Application



Danfoss Hansen Aluminium Flat Face ADB coupling is a flat face/dry break coupling used for cooling systems in electric applications with circulating water and antifreeze fluids. This coupling is providing an enhanced solution for preventing spillage of cooling agent which can cause technical failures, system shutdowns, and difficult clean-ups.

Product Features

- Aluminium construction extends life for safer operations and reduced maintenance.
- Enhances operations in demanding applications with heat and vibration compared to plastic couplings.
- Up to 62% higher flow than ISO 16028 requirements to improve efficiency.
- 4-times safety factor at maximum operating pressure of 25 bar.
- Options are available for railway applications with an enhanced version for vibration resistance tested according to EN 61373.
- Pre-guided system that helps users pre-position the coupling in difficult environments, making connection easy and reducing maintenance time.
- Full range of optional seals, end connections and sizes, helping manufacturers benefit from the design in any type of application.

Physical Characteristics

ADB Model	ISO size	Body size	Nominal Flow Diameter	Max. Operating Pressure	Rated* Flow	Air Inclusion	Fluid Loss	Force to Connect		
-	(mm)	(in)	(mm)	(bar)	(psi)	(lpm)	ml-cc.	ml-cc.	N	lbf
A2DB	6.3	1/4"	5.9	25	360	25	0.002	0.001	77	17
A3DB	10	3/8"	9	25	360	80	0.012	0.03	103	23
A4DB	12.5	1/2"	11.5	25	360	110	0.012	0.025	110	25
A6DB	19	3/4"	15	25	360	150	0.03	0.05	193	43
A8DB	25	1"	18.5	25	360	290	0.15	0.13	180	40

* Indicated values refer to a 1 bar / 14.5 psi pressure drop with water values obtained by projection of pressure drops measured with Oil

Applications & Markets

- Electrical cooling applications
- Renewable energy
- Railway
- Processing industry
- Data centers

Flow Data

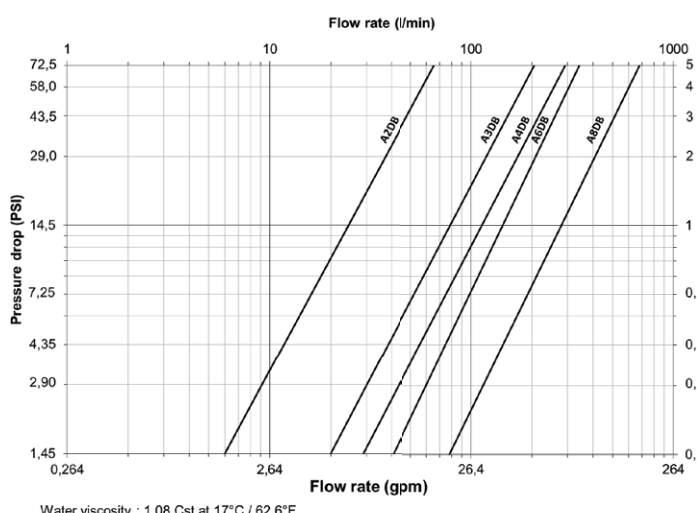

Seal Elastomer Data*

Seal Elastomer	Max. Operation Temperature Range
EPDM (Ethylene-Propylene)	-40°C +150°C / -40°F +302°F

*Other sealing material could be available, contact Danfoss technical support for further information on sealing availability.

**For reference only, based on Danfoss recommended temperatures.

Contact Danfoss technical support for further information on fluid compatibility

ADB Series (Aluminium) Flat Face/Dry Break

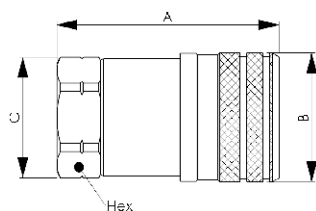

Figure 1

End-connection

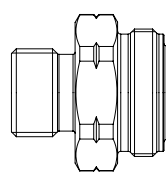

Figure 2

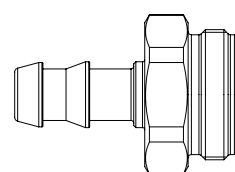

Figure 3

Sockets (Female)

Part Number	Fig.	Body Size (in)	Thread Size			Dimensions			Hex1 (in)	A (mm)	B (mm)	C (mm)	Hex1 (mm)	Weight	
			BSPP female	BSPP male	Hosebarb	A (in)	B (in)	C (in)						(lbs)	(g)
A2DBS25BS192	1	1/4'	1/4'	-	-	1.84	1.06	0.96	0.87	46.7	26.8	24.5	22	0,104	47
A2DBS25MBS192	2	1/4'	-	1/4'	-	1.84	1.06	0.96	0.87	46.7	26.8	24.5	22	0,106	48
A2DBS25HT192	3	1/4'	-	-	1/4'	1.84	1.06	0.96	0.87	46.7	26.8	24.5	22	0,106	48
A2DBS37HT192	3	1/4'	-	-	3/8'	1.84	1.06	0.96	0.87	46.7	26.8	24.5	22	0,106	48
A3DBS37BS192	1	3/8'	3/8'	-	-	2.42	1.26	1.16	1.06	61.5	32	29.5	27	0,192	87
A3DBS37MBS192	2	3/8'	-	3/8'	-	2.42	1.26	1.16	1.06	61.5	32	29.5	27	0,192	87
A3DBS37HT192	3	3/8'	-	-	3/8'	2.42	1.26	1.16	1.06	61.5	32	29.5	27	0,190	86
A3DBS50BS192	1	3/8'	1/2'	-	-	2.42	1.26	1.16	1.06	61.5	32	29.5	27	0,192	87
A3DBS50MBS192	2	3/8'	-	1/2'	-	2.42	1.26	1.16	1.06	61.5	32	29.5	27	0,205	93
A3DBS50HT192	3	3/8'	-	-	1/2'	2.42	1.26	1.16	1.06	61.5	32	29.5	27	0,201	91
A4DBS50BS192	1	1/2'	1/2'	-	-	2.49	1.49	1.4	1.26	63.3	37.9	35.5	32	0,284	129
A6DBS75BS192	1	3/4'	3/4'	-	-	3.48	1.89	1.83	1.61	88.5	48	46.5	41	0,613	278
A8DBS100BS192	1	1'	1'	-	-	3.70	2.26	2.16	1.97	93.9	57.4	54.9	50	0,939	426

*Alternative end connections available upon request.

To obtain connected length of coupling, add dimensions A (Fig. 1) and G (Fig. 4) together.

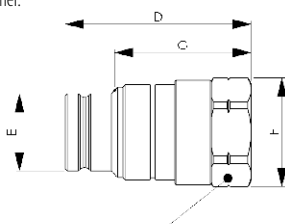

Figure 4

End-connection

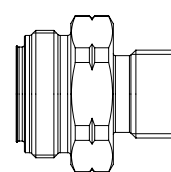

Figure 5

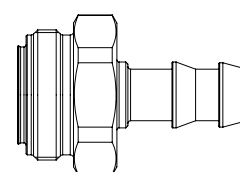

Figure 6

Plugs (Male)

Part Number	Fig.	Body Size (in)	Thread Size			Dimensions				Hex1 (in)	D (mm)	E (mm)	F (mm)	G (mm)	Hex1 (mm)	Weight	
			BSPP female	BSPP male	Hosebarb	D (in)	E (in)	F (in)	G (in)							(lbs)	(g)
A2DBP25BS192	4	1/4'	1/4'	-	-	1.71	0.65	0.96	1.26	0.87	43.5	16.5	24.5	32.1	22	0,062	28
A2DBP25MBS192	5	1/4'	-	1/4'	-	1.71	0.65	0.96	1.26	0.87	43.5	16.5	24.5	32.1	22	0,064	29
A2DBP25HT192	6	1/4'	-	-	1/4'	1.71	0.65	0.96	1.26	0.87	43.5	16.5	24.5	32.1	22	0,064	29
A2DBP37HT192	6	1/4'	-	-	3/8'	1.71	0.65	0.96	1.26	0.87	43.5	16.5	24.5	32.1	22	0,064	29
A3DBP37BS192	4	3/8'	3/8'	-	-	2.25	0.77	1.16	1.45	1.06	57.1	19.7	29.5	39.5	27	0,117	53
A3DBP37MBS192	5	3/8'	-	3/8'	-	2.25	0.77	1.16	1.45	1.06	57.1	19.7	29.5	39.5	27	0,117	53
A3DBP37HT192	6	3/8'	-	-	3/8'	2.25	0.77	1.16	1.45	1.06	57.1	19.7	29.5	39.5	27	0,115	52
A3DBP50BS192	4	3/8'	1/2'	-	-	2.25	0.77	1.16	1.45	1.06	57.1	19.7	29.5	39.5	27	0,117	53
A3DBP50MBS192	5	3/8'	-	1/2'	-	2.25	0.77	1.16	1.45	1.06	57.1	19.7	29.5	39.5	27	0,130	59
A3DBP50HT192	6	3/8'	-	-	1/2'	2.25	0.77	1.16	1.45	1.06	57.1	19.7	29.5	39.5	27	0,126	57
A4DBP50BS192	4	1/2'	1/2'	-	-	2.39	0.99	1.4	1.59	1.26	60.6	25.2	35.5	40.4	32	0,194	88
A6DBP75BS192	4	3/4'	3/4'	-	-	3.28	1.29	1.83	2.27	1.61	83.4	32.8	46.5	57.7	41	0,375	170
A8DBP100BS192	4	1'	1'	-	-	3.52	1.59	2.16	2.44	1.97	89.4	40.4	54.9	62	50	0,591	268

*Alternative end connections available upon request.

To obtain connected length of coupling, add dimensions A (Fig. 1) and G (Fig. 4) together.

Color Coding Ring Option*

Body Size (in)	ISO Size (mm)	Size	Socket/Female Ring Part Number**				Plug/Male Ring Part Number**				Tool Part Number	Tool & Rings Kit Part Number***
			Blue	Red	Yellow	Green	Blue	Red	Yellow	Green		
1/2	12.5	12FF	CR12FFSLB	CR12FFSRD	CR12FFSYL	CR12FFSDG	CR12FFPLB	CR12FFPRD	CR12FFPYL	CR12FFPDG	CR12FFSP93	CRKIT12FF

For color coded rings TPE material is used that offers excellent flexibility which allows a very good shock resistance in demanding applications.

Good thermal, chemical and weather resistance provides a great fit on the coupling and a extended life time in toughest conditions.

The color coded rings are easy to install by using the referenced tools. Please refer to the user guide on danfoss/qdc.com

* For requests on alternative colors or installation instructions, please contact your Danfoss sales representative.

** Orders must be in multiples of 10 pcs.

*** The kit consists of a tool plus 10 socket rings and 10 plug rings of each color.



FD83 Series

Full Flow Dual Interlock

Thermal Management Application



Danfoss Hansen's FD83 is designed for fluid transfer and electronics cooling applications where full flow, fluid compatibility and safety are essential. The FD83 identical halves include two interlock features to eliminate spills and ensure maximum safety. Valves cannot be opened until the coupling halves are mated and coupling halves cannot be disconnected until both halves are closed.

Product Features

- Dual interlock safety feature eliminates accidental opening of coupling when disconnected with the use of a patented locking pin design and lever handle
- Design provides reliable performance and no spillage during maintenance or service
- Standard seal material: EPDM, additional material available on request
- Standard body material: 303 stainless steel
- Full flow coupling
- Color coded bumper seals are available
- Identical coupling halves
- Maintenance and service friendly
- 303 stainless steel material provides broad fluid compatibility
- Wide range of terminal end options

Physical Characteristics

Coupling Size	Max. Operating Pressure Connected				Min. Burst Pressure Connected				Rated Flow	Fluid Loss	CV Value					
	Socket/Female Half		Socket/Female Half		Socket/Female Half		Socket/Female Half									
(in)	(bar)	(psi)	(bar)	(psi)	(bar)	(psi)	(bar)	(psi)	(bar)	(psi)	(lpm)	(gpm)	cc. max			
1	10	150	10	150	10	150	20	300	20	300	20	300	189	50	5.0	30
2 New!	10	150	10	150	10	150	20	300	20	300	20	300	800	211	12	127

Note: Not for use with dangerous gazes classified in Group 1

FD83 Series

Full Flow Dual Interlock

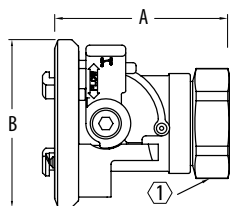

Figure 1

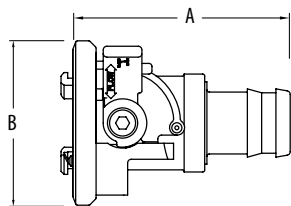

Figure 2

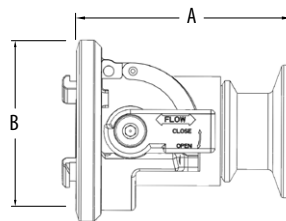

Figure 3

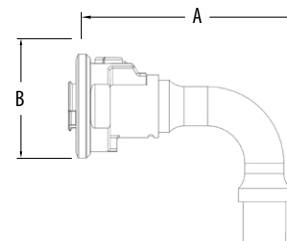

Figure 4

Dimensions

Part Number	Body Size	Port Size	Thread	Type	Fig.	Dimensions A		Dimensions B		Hex (mm)	Hex (in)
						(mm)	(in)	(mm)	(in)		
FD83-2052-16-16	1	1	1-11- 1/2	Female NPTF	1	(95.5)	(3.76)	(71.6)	(2.82)	(41)	(1.63)
FD83-2052-12-16	1	3/4	3/4-14	Female NPTF	1	(70.1)	(2.76)	(71.6)	(2.82)	(41)	(1.63)
FD83-2046-16-16	1	1	NA	1" Hose Barb	2	(84.2)	(3.31)	(71.6)	(2.82)	-	-
FD83-2092-16-16	1	1	NA	1" Hose Barb 90°	4	(125)	(4.92)	(71.6)	(2.82)	-	-
FD83-2096-16-16	1	1	1 5/16-12	Male ORB	1	(95.5)	(3.76)	(71.6)	(2.82)	(41)	(1.63)
FD83-2098-16-16	1	1	G1-11	Male BSPP	1	(95.5)	(3.76)	(71.6)	(2.82)	(41)	(1.63)
FD83-2127-32-32	2	2	2	Female BSPP	1	(122.4)	(4.82)	(105.3)	(4.15)	(70)	(2.76)
FD83-2128-32-32	2	2	NA	Sanitary Flange	3	(102.4)	(4.03)	(105.3)	(4.15)	-	-

Other end connections available upon request.

Applications & Markets

- Data Centers
- Mobile Battery Cooling
- Thermal Management Systems
- Industrial Fluid Transfer

Flow Data

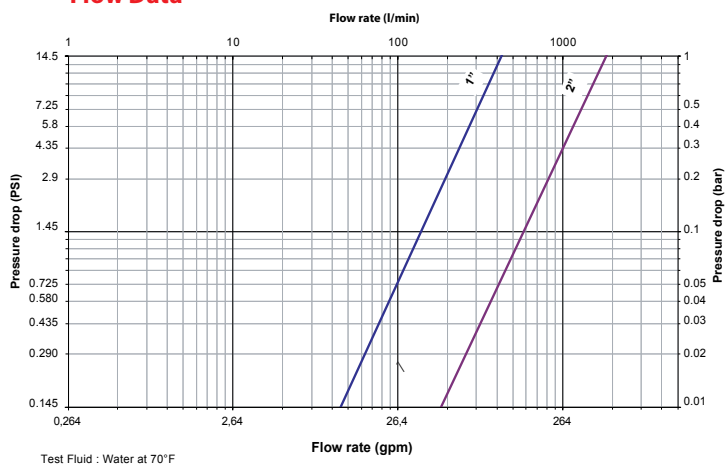

UQD Series

Thermal Management Application

Danfoss' UQD is designed for fluid transfer and electronics cooling applications, available in 4 different sizes and 2 color options. It complies with OCP (Open Compute Project) and exceeds requirements of specified performance characteristics. Danfoss UQD offers color identification (red and blue) and guarantees 100% helium-leak testing.



Product Features

- Designed per OCP (Open Compute Project) UQD specification
- Push-to-connect design
- High flow and no spillage
- Double shut off - flat face valves
- Exceeds OCP flow ratings at least by 25% resulting in reduction in overall energy consumption
- Best in class force to connect
- Standard material: 303, 304 stainless steel provides broad fluid compatibility
- Standard seal material: EPDM
- Color anodized aluminum sleeves
- Color coded (red/blue) sleeves on socket and O-rings on plug
- Wide range of terminal end options: ORB, BSPP on plug and push on hose on socket. Additional configurations available upon request
- Operating temperature -40°C to +150°C
- Typical working pressure: 6.9 Bar, up to 20 bar for smaller sizes

Size	Body Size	Nominal Flow Diameter	Max operating pressure						Min burst pressure						Rated Flow	Cv Value	Air Inclusion	Fluid Loss	
			Connected		Socket / Female Half		Plug / Male Half		Connected		Socket / Female Half		Plug / Male Half						
	(in)	(mm)	(bar)	(psi)	(bar)	(psi)	(bar)	(psi)	(bar)	(psi)	(bar)	(psi)	(bar)	(psi)	(lpm)	(gpm)	-	cc. max.	cc. max.
UQD02	1/8	2.8	20	290	20	290	20	290	60	870	60	870	60	870	2.1	0.6	0.33	0.004	0.007
UQD04	1/4	5.5	16	232	16	232	16	232	48	696	48	696	48	696	6.4	1.7	1.37	0.024	0.01
UQD06	3/8	6.3	6.9	100	6.9	100	6.9	100	20.7	300	20.7	300	20.7	300	11.4	3.0	2.37	0.027	0.022
UQD08	1/2	8.9	6.9	100	6.9	100	6.9	100	20.7	300	20.7	300	20.7	300	17.8	4.7	5.32	0.029	0.03

Size	Force to Connect		Recommended Torque			
	N	lb	ORB size	N-m	BSP Size	N-m
UQD02	48	10.79	7/16-20	11-12	1/8"	8-9
UQD04	50	11.24	9/16-18	18-20	3/8"	18-20
UQD06	73	16.41	3/4-16	52-57	3/8"	18-20
UQD08	87	19.56	7/8-14	58-64	1/2"	34-37

Applications & Markets

- Liquid cooling application
- Data center application

Seal Elastomer Data

Seal elastomer	P/N Code	Operation Temperature Range	
		C°	F°
EPDM	-	-40°C +150°C	-40°F +302°F

Force to Connect vs Pressure

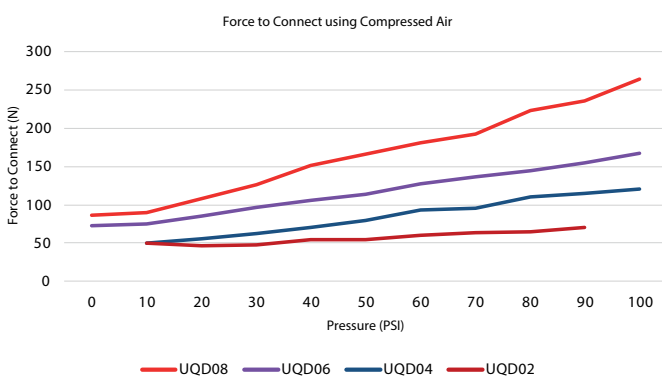

Flow Data

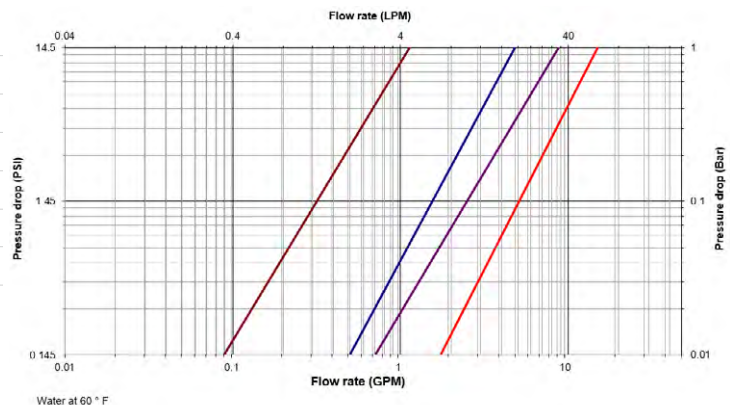

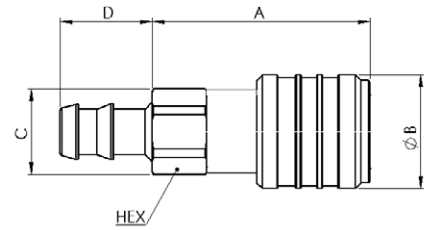

Figure 1
Push on socketless fitting

UQD	Part number	Details		Dimensions									
		Thread / end size	Fig.	A		B		C		D		Hex	
		Hose Tail	n°	(mm)	(in)	(mm)	(in)	(mm)	(in)	(mm)	(in)	(mm)	(in)
UQD02	2UQS25HABL* 2UQS25HARD*	1/4	1	46.2	1.82	23	0.91	15.5	0.61	19	0.75	14	0.55
UQD04	4UQS37HABL* 4UQS37HARD*	3/8	1	60.7	2.39	28.7	1.13	20	0.79	22	0.87	18	0.71
UQD06	6UQS50HABL* 6UQS50HARD*	1/2	1	61.1	2.41	31.7	1.25	24	0.94	25.8	1.02	22	0.87
UQD08	8UQS62HABL 8UQS62HARD	5/8	1	68.4	2.69	35	1.38	30	1.18	39	1.54	27	1.06

Note 1: To obtain connected length of coupling, add dimensions A (Fig. 1) and G (Fig. 2) together.

Note 2: For color options, RD suffix corresponds to RED and BL suffix to BLUE

*For EMEA, China and APAC region UQD02, UQD04 and UQD06 need to be ordered with Prefix "ML" (eg. ML2UQP43ORMBL)

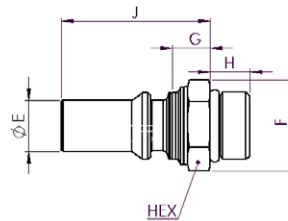

Figure 2
Male ORB ISO 11926-3

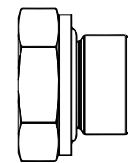

Figure 3
ISO 1179-3

UQD	Part number	Details			Dimensions											
		Thread / end size	Fig.	E	F	G	H	J	Hex							
		BSP	ORB	n°	(mm)	(in)	(mm)	(in)	(mm)	(in)	(mm)	(in)	(mm)	(in)		
UQD02	2UQP43ORMBL* 2UQP43ORMRD*	-	7/16-20	2	6.65	0.26	16.17	0.64	8.7	0.34	9.1	0.36	29.3	1.15	14	0.55
	ML2UQP12MBSBL ML2UQP12MBSRD	1/8	-	3	6.65	0.26	17.32	0.68	8.7	0.34	8	0.31	30.4	1.20	15	0.59
UQD04	4UQP56ORMBL* 4UQP56ORMRD*	-	9/16-18	2	11.07	0.44	19.63	0.77	9.8	0.39	9.9	0.39	37.9	1.49	17	0.67
	ML4UQP37MBSBL ML4UQP37MBSRD	3/8	-	3	11.07	0.44	25.40	1.00	9.8	0.39	11.2	0.44	37.9	1.49	22	0.87
UQD06	6UQP75ORMBL* 6UQP75ORMRD*	-	3/4-16	2	14.3	0.56	25.40	1.00	10	0.39	11.1	0.44	41.6	1.64	22	0.87
	ML6UQP37MBSBL ML6UQP37MBSRD	3/8	-	3	14.3	0.56	25.40	1.00	10	0.39	11.2	0.44	41.6	1.64	22	0.87
UQD08	8UQP87ORMBL 8UQP87ORMRD	-	7/8-14	2	17.48	0.69	31.18	1.23	12	0.47	12.7	0.50	47.6	1.87	27	1.06
	8UQP50MBSBL 8UQP50MBSRD	1/2	-	3	17.48	0.69	34.64	1.36	12	0.47	14.5	0.57	47.6	1.87	30	1.18

Note 1: To obtain connected length of coupling, add dimensions A (Fig. 1) and G (Fig. 2) together.

Note 2: For color options, RD suffix corresponds to RED and BL suffix to BLUE

*For EMEA, China and APAC region UQD02, UQD04 and UQD06 need to be ordered with Prefix "ML" (eg. ML2UQP43ORMBL).

Flo-Temp Series

Thermal Management Application



Danfoss' Flo-Temp™ quick disconnect couplings provide the flow needed to cool or heat molds and die casting dies. Sockets are available non-valved for maximum flow and valved to prevent fluid loss when disconnected. Flo-Temp couplings can be used with water-glycol, hot water and hot oil.

Product Features

- Non valved straight through models for maximum flow
- Valved sockets/females for automatic shut-off when line is disconnected
- Sockets/Females available with straight, 90° or 45° hose stems or without hose stem
- Brass plugs/males with male pipe thread for recessed mounting to avoid damage to plugs/males when molds are being changed or stored.
- Standard body material: Brass

Physical Characteristics

Size (in)	Max. Operating Pressure		Min. Burst Pressure		Rated Flow	
	(bar)	(psi)	(bar)	(psi)	(lpm)	(gpm)
1/4	14	200	56	800	8.3	2.2
3/8	14	200	56	800	17	4.5
1/2	14	200	56	800	49	13

Applications & Markets

- Injection Molding
- Heating and Cooling

Flow Data

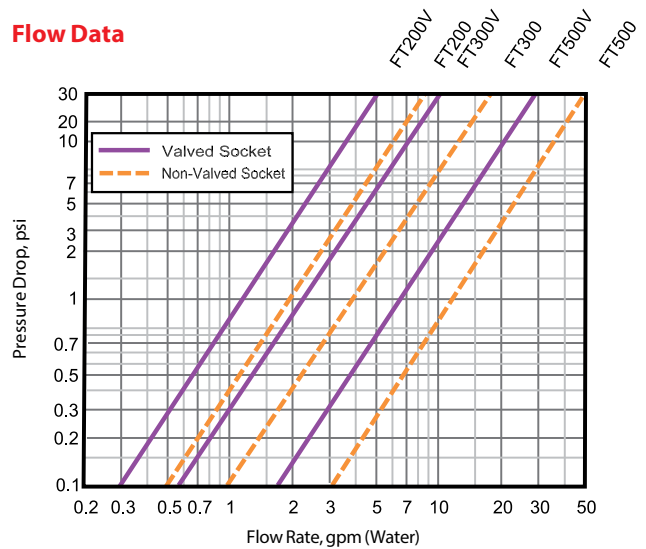

Flo-Temp Series

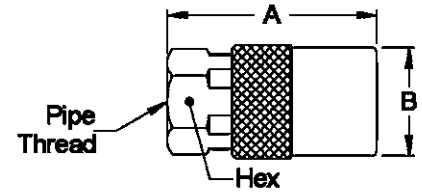

Figure 1

Without Hose Stem

Part Number	Coupling Type	Body Size	Port Size	Thread	Type	Fig.	Dimensions					
							A (in)	B (in)	Hex (in)	A (mm)	B (mm)	Hex (mm)
LNFT200	Socket/Female	1/4	1/8	1/8-27	NPTF	1	1.68	0.67	0.56	42.7	17.0	14.2
LNFT300	Socket/Female	3/8	1/4	1/4-18	NPTF	1	2.18	0.89	0.75	55.4	22.6	19.1
LNFT500	Socket/Female	1/2	1/2	1/2-14	NPTF	1	2.00	1.17	1.13	50.8	29.7	28.7

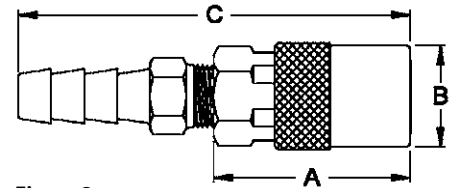

Figure 2

Straight Hose Stem

Part Number Non-Valved	Valved	Coupling Type	Body Size	Type	Hose I.D.	Fig.	Dimensions					
							A (in)	B (in)	C (in)	A (mm)	B (mm)	C (mm)
FTS204	FTS204V	Socket/Female	1/4	Hose Stem	1/4	2	1.20	0.67	2.25	30.5	17.0	57.2
FTS204HP*	FTS204VHP*	Socket/Female	1/4	Hose Stem	1/4	2	1.20	0.67	2.09	30.5	17.0	53.1
FTS205	FTS205V	Socket/Female	1/4	Hose Stem	5/16	2	1.20	0.67	2.09	30.5	17.0	53.1
FTS206	FTS206V	Socket/Female	1/4	Hose Stem	3/8	2	1.20	0.67	2.25	30.5	17.0	57.2
FTS206HP*	-	Socket/Female	1/4	Hose Stem	3/8	2	1.20	0.67	2.34	30.5	17.0	59.4
FTS306	FTS306V	Socket/Female	3/8	Hose Stem	3/8	2	1.60	0.91	2.68	40.6	23.1	68.1
FTS306HP*	FTS306VHP*	Socket/Female	3/8	Hose Stem	3/8	2	1.61	0.89	2.75	40.9	22.6	69.9
FTS308	FTS308V	Socket/Female	3/8	Hose Stem	1/2	2	1.61	0.88	2.82	40.9	22.4	71.6
FTS308HP*	FTS308VHP*	Socket/Female	3/8	Hose Stem	1/2	2	1.61	0.88	2.82	40.9	22.4	71.6
FTS504	FTS504V	Socket/Female	1/2	Hose Stem	1/2	2	2.25	1.18	3.42	57.2	30.0	86.9
FTS504HP*	FTS504VHP*	Socket/Female	1/2	Hose Stem	1/2	2	2.25	1.18	3.62	57.2	30.0	91.9
FTS506	FTS506V	Socket/Female	1/2	Hose Stem	3/4	2	2.22	1.18	3.85	56.4	30.0	97.8
FTS506HP*	FTS506VHP*	Socket/Female	1/2	Hose Stem	3/4	2	2.22	1.18	4.35	56.4	30.0	110.5

*Part numbers with HP suffix have pushon hose barb. All other FTS parts numbers have standard hose barb.

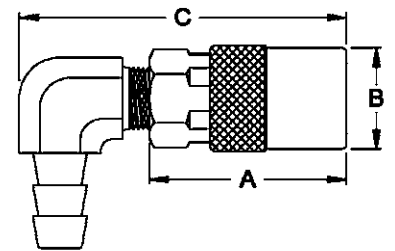

Figure 3

90° Hose Stem

Part Number Non-Valved	Valved	Coupling Type	Body Size	Type	Hose I.D.	Fig.	Dimensions					
							A (in)	B (in)	C (in)	A (mm)	B (mm)	C (mm)
FTS214	FTS214V	Socket/Female	1/4	Hose Stem	1/4	3	1.36	0.67	2.17	34.5	17.0	55.1
FTS214HP*	FTS214VHP*	Socket/Female	1/4	Hose Stem	1/4	3	1.18	0.67	1.76	30.0	17.0	44.7
FTS215	FTS215V	Socket/Female	1/4	Hose Stem	5/16	3	1.18	0.67	1.76	30.0	17.0	44.7
FTS216	FTS216V	Socket/Female	1/4	Hose Stem	3/8	3	1.17	0.67	1.76	29.7	17.0	44.7
FTS216HP*	FTS216VHP*	Socket/Female	1/4	Hose Stem	3/8	3	1.17	0.67	1.76	29.7	17.0	44.7
FTS316	FTS316V	Socket/Female	3/8	Hose Stem	3/8	3	1.60	0.88	2.43	40.6	22.4	61.7
FTS316HP*	FTS316VHP*	Socket/Female	3/8	Hose Stem	3/8	3	1.60	0.88	2.43	40.6	22.4	61.7
FTS318	FTS318V	Socket/Female	3/8	Hose Stem	1/2	3	1.60	0.88	2.43	40.6	22.4	61.7
FTS318HP*	FTS318VHP*	Socket/Female	3/8	Hose Stem	1/2	3	1.60	0.88	2.43	40.6	22.4	61.7

*Part numbers with HP suffix have pushon hose barb. All other FTS parts numbers have standard hose barb.

Flo-Temp Series

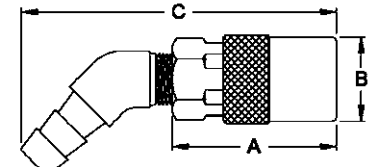

Figure 4

45° Hose Stem

Part Number	Valved	Coupling Type	Body Size	Type	Hose I.D.	Fig.	Dimensions					
							A	B	C	A	B	C
Non-Valved							(in)	(in)	(in)	(mm)	(mm)	(mm)
FTS224	FTS224V	Socket/Female	1/4	Hose Stem	1/4	4	1.17	0.67	2.40	29.7	17.0	61.0
FTS224HP*	FTS224VHP*	Socket/Female	1/4	Hose Stem	1/4	4	1.17	0.67	2.40	29.7	17.0	61.0
FTS225	FTS225V	Socket/Female	1/4	Hose Stem	5/16	4	1.17	0.67	2.40	29.7	17.0	61.0
FTS226	FTS226V	Socket/Female	1/4	Hose Stem	3/8	4	1.17	0.67	2.40	29.7	17.0	61.0
FTS226HP*	FTS226VHP*	Socket/Female	1/4	Hose Stem	3/8	4	1.17	0.67	2.40	29.7	17.0	61.0
FTS326	FTS326V	Socket/Female	3/8	Hose Stem	3/8	4	1.80	0.90	3.70	45.7	22.9	94.0
FTS326HP*	FTS326VHP*	Socket/Female	3/8	Hose Stem	3/8	4	1.80	0.90	3.17	45.7	22.9	80.5
FTS328	FTS328V	Socket/Female	3/8	Hose Stem	1/2	4	1.60	0.90	3.17	40.6	22.9	80.5
FTS328HP*	FTS328VHP*	Socket/Female	3/8	Hose Stem	1/2	4	1.60	0.90	3.17	40.6	22.9	80.5

*Part numbers with HP suffix have pushon hose barb. All other FTS parts numbers have standard hose barb

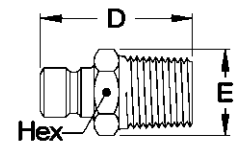

Figure 5

Male Pipe Thread

Part Number	Coupling Type	Body Size	Port Size	Thread	Type	Fig.	Dimensions						Installation Recess			
							A	B	C	A	B	C	DIA	Depth	DIA	Depth
							(in)	(in)	(in)	(mm)	(mm)	(mm)	(in)	(in)	(mm)	(mm)
FTP251	Plug/Male	1/4	1/8	1/8-27	NPTF	5	0.94	0.49	0.44	23.9	12.4	11.2	0.69	0.69	17.5	17.5
FTP251BST	Plug/Male	1/4	1/8	1/8-28	BSPT	5	0.94	0.49	0.44	23.9	12.4	11.2	0.69	0.69	17.5	17.5
FTP252	Plug/Male	1/4	1/4	1/4-18	NPTF	5	1.15	0.63	0.56	29.2	16.0	14.2	0.84	0.94	21.3	23.9
FTP252BST	Plug/Male	1/4	1/4	1/4-19	BSPT	5	1.15	0.63	0.56	29.2	16.0	14.2	0.84	0.94	21.3	23.9
FTP253	Plug/Male	1/4	3/8	3/8-18	NPTF	5	1.19	0.77	0.69	30.2	19.6	17.5	1.00	0.94	25.4	23.9
FTP352	Plug/Male	3/8	1/4	1/4-18	NPTF	5	1.40	0.63	0.56	35.6	16.0	14.2	1.00	1.09	25.4	27.7
FTP352BST	Plug/Male	3/8	1/4	1/4-19	BSPT	5	1.40	0.63	0.56	35.6	16.0	14.2	1.00	1.09	25.4	27.7
FTP353	Plug/Male	3/8	3/8	3/8-18	NPTF	5	1.40	0.77	0.69	35.6	19.6	17.5	1.00	1.13	25.4	28.7
FTP353BST	Plug/Male	3/8	3/8	3/8-19	BSPT	5	1.40	0.77	0.69	35.6	19.6	17.5	1.00	1.13	25.4	28.7
FTP354	Plug/Male	3/8	1/2	1/2-14	NPTF	5	1.56	0.98	0.88	39.6	24.9	22.4	1.19	1.25	30.2	31.8
FTP554	Plug/Male	1/2	1/2	1/2-14	NPTF	5	1.75	0.98	0.88	44.5	24.9	22.4	1.25	1.50	31.8	38.1
FTP556	Plug/Male	1/2	3/4	3/4-14	NPTF	5	1.75	1.25	1.13	44.5	31.8	28.7	1.50	1.56	38.1	39.6

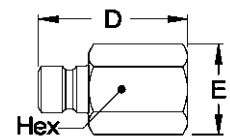

Figure 6

Female End Connections

Part Number	Coupling Type	Body Size	Port Size	Thread	Type	Fig.	Dimensions					
							D	E	Hex	D	E	Hex
							(in)	(in)	(in)	(mm)	(mm)	(mm)
FTP251F	Plug/Male	1/4	1/8	1/8-27	NPTF	6	1.00	0.58	0.50	25.4	14.7	12.7
FTP251FBS	Plug/Male	1/8	1/8	1/8-28	BSPT	6	1.00	0.65	0.56	25.4	16.5	14.2
FTP252F	Plug/Male	1/4	1/4	1/4-18	NPTF	6	1.20	0.72	0.63	30.5	18.3	16.0
FTP252FBS	Plug/Male	1/4	1/4	1/4-19	BSPT	6	1.20	0.87	0.75	30.5	22.1	19.1
FTP253F	Plug/Male	1/4	3/8	3/8-18	NPTF	6	1.25	0.87	0.75	31.8	22.1	19.1
FTP352F	Plug/Male	3/8	1/4	1/4-18	NPTF	6	1.38	0.72	0.63	35.1	18.3	16.0
FTP352FBS	Plug/Male	1/4	1/4	1/4-19	BSPT	6	1.28	0.87	0.75	32.5	22.1	19.1
FTP353F	Plug/Male	3/8	3/8	3/8-18	NPTF	6	1.40	0.87	0.75	35.6	22.1	19.1
FTP354F	Plug/Male	3/8	1/2	1/2-14	NPTF	6	1.62	1.08	0.94	41.1	27.4	23.9
FTP554F	Plug/Male	1/2	1/2	1/2-14	NPTF	6	1.72	1.08	0.94	43.7	27.4	23.9
FTP556F	Plug/Male	1/2	3/4	3/4-14	NPTF	6	1.78	1.30	1.13	45.2	33.0	28.7

Couplings for refrigerant applications



Table of Contents

Thread to connect

5400 Series.....	152
------------------	-----

5400 Series

Low Air Inclusion Refrigerant

Refrigerant Application

Danfoss Hansen 5400 Series low air inclusion product line is designed for air conditioning, refrigerant, gaseous and fluid transfer applications.



Product Features

- Brazed or threaded end connections for versatility of installation on tubing or hose
- Tubular valve construction for low fluid loss and air inclusion
- Thread together design allows connection and disconnection against pressure
- Lock washer and jam nut standard for optional bulkhead mounting
- Standard seal material: Neoprene
- Dura-Kote™ plating for excellent corrosion resistance

Physical Characteristics

Coupling Size (in)	Max. Operating Pressure Connected		Min. Burst Pressure Connected		Max. Operating Pressure Disconnected				Vacuum Connected Only (in./Hg)	Rated Flow		Air Inclusion cc. max.	Fluid Loss cc.max.
	(bar)	(psi)	(bar)	(psi)	Male Half (bar)	Female Half (bar)	(psi)	(psi)		(lpm)	(gpm)		
1/4	207	3,000	621	9,000	172	2,500	34	500	28	8	2	.10	.05
1/2	121	1,750	359	5,200	121	1,750	28	400	28	53	14	.10	.10
3/4	48	700	145	2,100	55	800	28	400	28	132	35	.30	.10
1	48	700	145	2,100	48	700	21	300	28	284	75	.50	.20

Applications & Markets

- Mobile air conditioning and refrigerant
- Thermal management

Flow Data

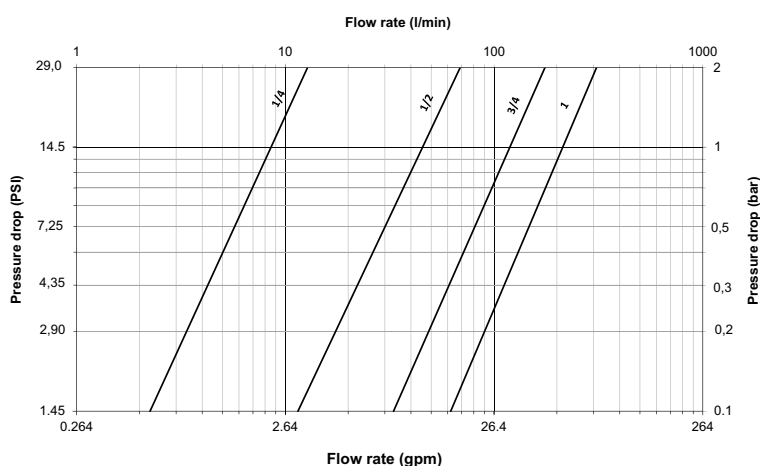

Air flow rate at 100 PSI (6.89 bar) Inlet Pressure

5400 Series

Low Air Inclusion Refrigerant

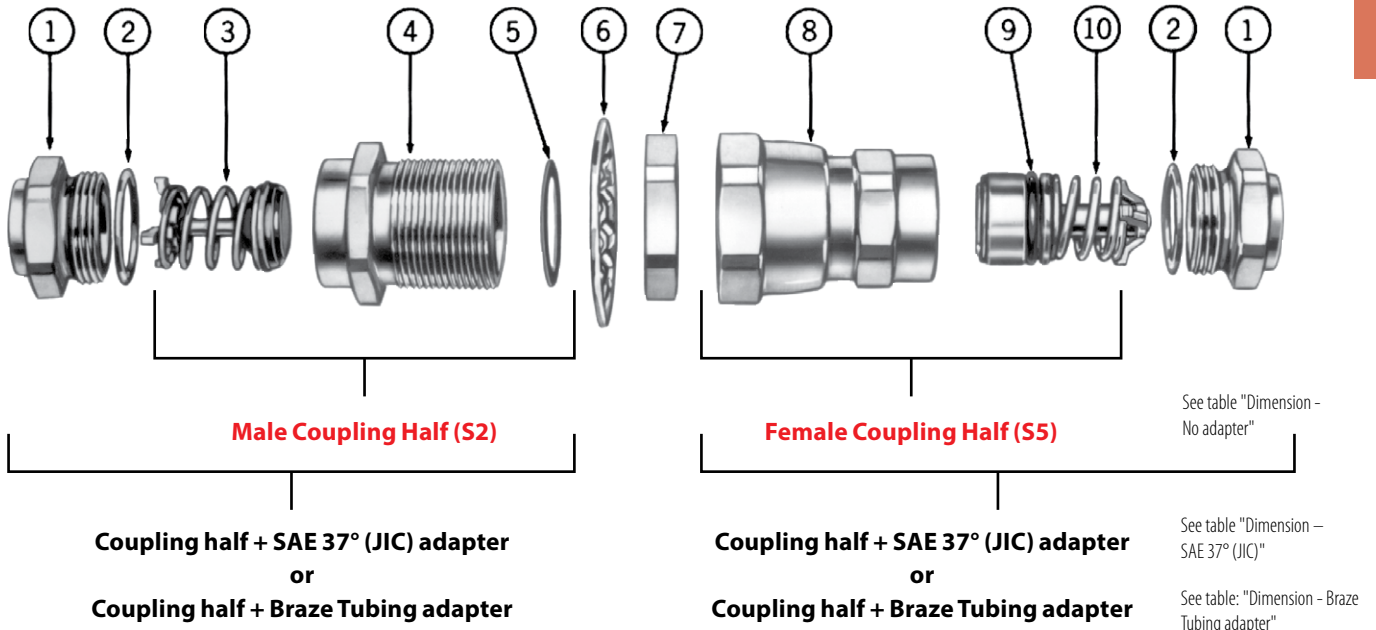

Item number/adapters	1 Tubing adapter	2 Adapter O-ring	3 Poppet valve assembly	4 Male body	5 Gasket seal	6 Lock washer	7 Jam nut	8 Union nut and female body assembly	9 Piston O-ring	10 Female valve assembly
SAE 37° (JIC)	202208-Y-X									
Braze tubing	202208-Y-XB	22546-Z-X	5400-S20-X	5400-17-XS	22008-X	5400-54-XS	5400-52-XS	5400-S16-X	FF91178-Z'	5400-S19-X
Hose fitting SAE 100R5	487-Y-XS									

Note 1: Replace "X", "Y" and "Z" by size number chosen in below tables.
 Note 2: "B" stands for Brass and "S" stands for Steel material – availability is presented in below tables.

Assembly Instructions

Steps:

- After tubing or hose has been connected to adapters ① and ②, install O-Rings ② and ③* on adapters. Be sure O-Rings are not twisted.
- Oil O-Rings ② and ③ liberally with system fluid to prevent them from scuffing and tearing when coupling body is threaded on adapter.
- S2 Half—Lubricate poppet face with system fluid. Insert poppet valve assembly ③ into body ④. Tighten body ④ on adapter ①. After body and adapter make metal-to-metal contact, tighten by rotating body ④ 1/8".
 S5 Half—Oil O-Ring ③* liberally with system fluid. Insert valve and sleeve assembly ⑩ into body ⑧. Tighten body ⑧ on adapter ②. After body and adapter make metal-to-metal contact, tighten by rotating body ⑧ 1/8".
- Coupling Connection—Lubricate gasket seal ⑤ on male half with system fluid. Thread lubricated union nut ⑧ on 5400-S2 half. Tighten union nut to torque values shown in table. Be sure male part and female part bodies do not rotate during connection.

Note: POE refrigeration oil for lubrication is recommended
 Note: Operating temperature: -40°C to 121°C / -104°F to -249.8°F

Bulkhead Mounting—Male half (S2)

Install lock washer ⑥ on S2 half. Insert S2 half through bulkhead, and tighten jam nut ⑦ so that lock washer teeth are fully compressed.

NOTE: Lock washer 6 must be between hex of S2 half and bulkhead.

Maximum Bulkhead Thickness

Body Size	Lock Washer Installed (in)	Lock Washer Not Used (in)
1/4	.206	.256
1/2	.136	.203
3/4	.232	.292
1	.101	.161

Torque Values

Recommended torque values in ft. lbs., are listed below.

Dash Size	Adapter to Body		
	Braze Type or Aluminum	Non-braze Type Steel or Brass	S2 Half to S5 Half
-4	6-8	12-15	10-12
-8	15-20	35-45	35-37
-12	35-40	45-55	45-47
-16	50-60	55-65	65-67

*IMPORTANT: Generous lubrication is required for all gaskets and O-Rings. Use refrigeration oil only when used in refrigerant system.

5400 Series

Low Air Inclusion Refrigerant

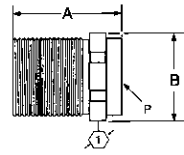

Figure 1

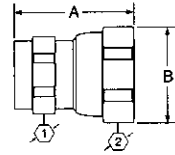

Figure 2

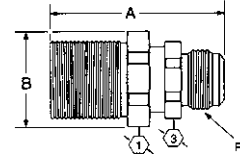

Figure 3

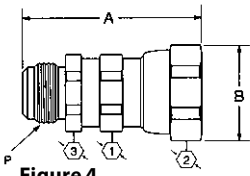

Figure 4

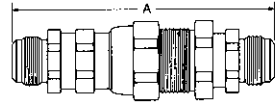

Figure 5

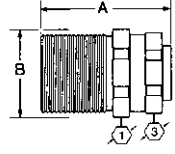

Figure 6

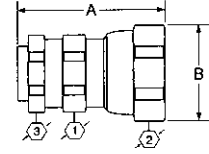

Figure 7

Dimensions – No Adapter

Part Number Neoprene	Coupling Type	Body Size	Type	Fig.	Dimensions A		B		Hex ①		Hex ②		Hex ③	
					(mm)	(in)	(mm)	(in)	(mm)	(in)	(mm)	(in)	(mm)	(in)
5400-S2-4	Male	1/4	No Adapter	1	(27.4)	(1.08)	(21.1)	(.83)	(19.1)	(.75)	-	-	-	-
5400-S5-4	Female	1/4	No Adapter	2	(28.7)	(1.13)	(21.1)	(.83)	(16.0)	(.63)	(19.1)	(.75)	(19.1)	(.75)
5400-S2-8	Male	1/2	No Adapter	1	(34.8)	(1.37)	(32.0)	(1.26)	(29.0)	(1.14)	-	-	-	-
5400-S5-8	Female	1/2	No Adapter	2	(40.6)	(1.60)	(33.0)	(1.30)	(26.0)	(1.02)	(30.0)	(1.18)	(30.0)	(1.18)
5400-S2-12	Male	3/4	No Adapter	1	(44.2)	(1.74)	(46.4)	(1.83)	(41.0)	(1.64)	-	-	-	-
5400-S5-12	Female	3/4	No Adapter	2	(55.1)	(2.17)	(45.0)	(1.77)	(35.0)	(1.38)	(41.0)	(1.61)	(41.0)	(1.61)
5400-S2-16	Male	1	No Adapter	1	(46.5)	(1.83)	(53.0)	(2.10)	(48.0)	(1.89)	-	-	-	-
5400-S5-16	Female	1	No Adapter	2	(61.1)	(2.41)	(56.0)	(2.20)	(45.0)	(1.77)	(50.0)	(1.97)	(50.0)	(1.97)

Dimensions – SAE 37° (JIC)

Part Number Buna-N	Coupling Type	Body Size	Port Size	Thread	Type	Fig.	Dimensions A		B		Hex ①		Hex ②		Hex ③	
							(mm)	(in)	(mm)	(in)	(mm)	(in)	(mm)	(in)	(mm)	(in)
5400 S2-4	Male	1/4	7/16	7/16-20	202220-4-4	3	(47.8)	(1.88)	(21.1)	(.83)	(19.1)	(.75)	-	-	(16.0)	(.63)
5400 S5-4	Female	1/4	7/16	7/16-20	202220-4-4	4	(49.0)	(1.93)	(21.1)	(.83)	(16.0)	(.63)	(19.1)	(.75)	(15.7)	(.62)
5400 S2-4	Male	1/4	9/16	9/16-18	202220-6-8	3	(48.0)	(1.89)	(21.1)	(.83)	(19.1)	(.75)	-	-	(16.0)	(.63)
5400 S5-4	Female	1/4	9/16	9/16-18	202220-6-8	4	(49.3)	(1.94)	(21.1)	(.83)	(16.0)	(.63)	(19.1)	(.75)	(15.7)	(.62)
5400 S2-8	Male	1/2	9/16	9/16-18	202220-6-8	3	(55.4)	(2.18)	(31.8)	(1.25)	(28.7)	(1.13)	-	-	(25.4)	(1.00)
5400 S5-8	Female	1/2	9/16	9/16-18	202220-6-8	4	(61.7)	(2.43)	(33.3)	(1.31)	(25.4)	(1.00)	(30.2)	(1.19)	(25.4)	(1.00)
5400 S2-8	Male	1/2	3/4	3/4-16	202220-8-8	3	(57.9)	(2.28)	(31.8)	(1.25)	(28.7)	(1.13)	-	-	(25.4)	(1.00)
5400 S5-8	Female	1/2	3/4	3/4-16	202220-8-8	4	(64.3)	(2.53)	(33.3)	(1.31)	(25.4)	(1.00)	(30.2)	(1.19)	(25.4)	(1.00)
5400 S2-12	Male	3/4	7/8	7/8-14	202220-10-12	3	(69.9)	(2.75)	(46.5)	(1.83)	(41.4)	(1.63)	-	-	(35.1)	(1.38)
5400 S5-12	Female	3/4	7/8	7/8-14	202220-10-12	4	(80.3)	(3.16)	(45.7)	(1.80)	(35.1)	(1.38)	(41.1)	(1.62)	(35.1)	(1.38)
5400 S2-12	Male	3/4	1 1/16	1 1/16-12	202220-12-12	3	(72.6)	(2.86)	(46.5)	(1.83)	(41.4)	(1.63)	-	-	(35.1)	(1.38)
5400 S5-12	Female	3/4	1 1/16	1 1/16-12	202220-12-12	4	(83.1)	(3.27)	(45.7)	(1.80)	(35.1)	(1.38)	(41.1)	(1.62)	(35.1)	(1.38)
5400 S2-16	Male	1	1 5/16	1 5/16-12	202220-16-16	3	(75.9)	(2.99)	(53.3)	(2.10)	(47.8)	(1.88)	-	-	(44.5)	(1.75)
5400 S5-16	Female	1	1 5/16	1 5/16-12	202220-16-16	4	(89.7)	(3.53)	(56.9)	(2.24)	(44.5)	(1.75)	(50.8)	(2.00)	(44.5)	(1.75)

Note: See Adapter SAE 37° (JIC) table for corresponding O-ring and adapter material

5400 Series

Low Air Inclusion Refrigerant

Dimensions – Braze Tubing Adapter

Part Number Neoprene	Coupling Type	Body Size	Tube O.D. Size	Type	Fig.	Dimensions									
						A		B		Hex ①		Hex ②		Hex ③	
						(mm)	(in)	(mm)	(in)	(mm)	(in)	(mm)	(in)	(mm)	(in)
5400 S2-4	Male	1/4	1/4	202208-4-4	6	(38.6)	(1.52)	(21.1)	(.83)	(19.1)	(.75)	-	-	(16.0)	(.63)
5400 S5-4	Female	1/4	1/4	202208-4-4	7	(39.9)	(1.57)	(21.1)	(.83)	(16.0)	(.63)	(19.1)	(.75)	(16.0)	(.63)
5400 S2-4	Male	1/4	3/8	202208-6-4	6	(38.6)	(1.52)	(21.1)	(.83)	(19.1)	(.75)	-	-	(16.0)	(.63)
5400 S5-4	Female	1/4	3/8	202208-6-4	7	(39.9)	(1.57)	(21.1)	(.83)	(16.0)	(.63)	(19.1)	(.75)	(16.0)	(.63)
5400 S2-8	Male	1/2	3/8	202208-6-8	6	(44.5)	(1.75)	(33.3)	(1.31)	(28.7)	(1.13)	-	-	(25.4)	(1.00)
5400 S5-8	Female	1/2	3/8	202208-6-8	7	(50.8)	(2.00)	(33.3)	(1.31)	(25.4)	(1.00)	(30.2)	(1.19)	(25.4)	(1.00)
5400 S2-8	Male	1/2	1/2	202208-8-8	6	(44.5)	(1.75)	(33.3)	(1.31)	(28.7)	(1.13)	-	-	(25.4)	(1.00)
5400 S5-8	Female	1/2	1/2	202208-8-8	7	(50.8)	(2.00)	(33.3)	(1.31)	(25.4)	(1.00)	(30.2)	(1.19)	(25.4)	(1.00)
5400 S2-12	Male	3/4	5/8	202208-10-12	6	(62.7)	(2.47)	(45.7)	(1.80)	(41.4)	(1.63)	-	-	(35.1)	(1.38)
5400 S5-12	Female	3/4	5/8	202208-10-12	7	(73.2)	(2.88)	(45.7)	(1.80)	(35.1)	(1.38)	(41.4)	(1.63)	(35.1)	(1.38)
5400 S2-12	Male	3/4	3/4	202208-12-12	6	(62.7)	(2.47)	(45.7)	(1.80)	(41.4)	(1.63)	-	-	(35.1)	(1.38)
5400 S5-12	Female	3/4	3/4	202208-12-12	7	(73.2)	(2.88)	(45.7)	(1.80)	(35.1)	(1.38)	(41.4)	(1.63)	(35.1)	(1.38)
5400 S2-16	Male	1	1	202208-16-16	6	(71.1)	(2.80)	(56.9)	(2.24)	(47.8)	(1.88)	-	-	(44.5)	(1.75)
5400 S5-16	Female	1	1	202208-16-16	7	(84.8)	(3.34)	(56.9)	(2.24)	(44.5)	(1.75)	(50.8)	(2.00)	(44.5)	(1.75)

Note: See "Adapter - Braze" table for corresponding O-ring and adapter material

Dust Caps and Dust Plugs

Dust Cap with Gasket	Dust Plug with Gasket	Body Size
5400-S6-4	5400-S8-4	1/4
5400-S6-8	5400-S8-8	1/2
5400-S6-12	5400-S8-12	3/4
5400-S6-16	5400-S8-16	1

Dust Cap

Dust Plug



Adapter SAE 37° (JIC)

O-Ring	Brass	Steel	Body Size	Thread	Tube O.D. Size
22546-12	202220-4-4B	202220-4-4S	1/4	7/16-20	1/4
22546-12	202220-6-4B	202220-6-4S	1/4	9/16-18	3/8
22546-17	-	202220-6-8S	1/2	9/16-18	3/8
22546-17	202220-8-8B	202220-8-8S	1/2	3/4-16	1/2
22546-23	-	202220-10-12S	3/4	7/8-14	5/8
22546-23	-	202220-12-12S	3/4	1 1/16-12	3/4
22546-28	-	202220-16-16S	3/4	1 3/16-12	1

Adapter SAE 37° (JIC)

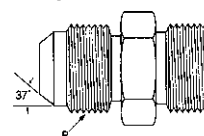

Adapter – Braze

O-Ring	Brass	Steel	Body Size	Thread	Tube O.D. Size
22546-12	202208-4-4B	-	1/4	1/2-20	1/4
22546-17	202208-4-8B	-	1/2	7/8-20	1/4
22546-12	202208-6-4B	-	1/4	1/2-20	3/8
22546-17	202208-6-8B	-	1/2	7/8-20	3/8
22546-17	202208-8-8B	-	1/2	7/8-20	1/2
2254617	202208-10-8B	202208-10-8S	1/2	7/8-20	5/8
22546-23	202208-10-12B	202208-10-12S	3/4	1 1/4-18	5/8
22546-23	202208-12-12B	-	3/4	1 1/4-18	3/4
22546-23	202208-14-12B	-	3/4	1 1/4-18	7/8
22546-28	202208-14-16B	-	1	1 19/32-20	7/8
22546-28	202208-16-16B	-	1	1 19/32-20	1
22546-28	202208-18-16B	-	1	1 19/32-20	1 1/8
22546-28	202208-20-16B	-	1	1 19/32-20	1 3/16
22546-28	202208-22-16B	-	1	1 19/32-20	1 1/4

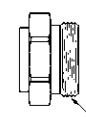
Adapter – Braze
(O-Ring Required)

Hose Fitting SAE 100R5†

O-Ring	Fitting Assembly	Body Size	Hose Size	Thread	Dimensions	
					mm	(in)
22546-12	487-4-4S	1/4	-4	1/2-20	23.4	(.92)
22546-12	487-4-6S	1/4	-6	1/2-20	24.4	(.96)
22546-17	487-8-6S	1/2	-6	7/8-20	24.4	(.96)
22546-17	487-8-8S	1/2	-8	7/8-20	26.9	(1.06)
22546-23	487-12-10S	3/4	-10	1 1/4-18	27.2	(1.07)
22546-23	487-12-12S	3/4	-12	1 1/4-18	27.2	(1.07)
22546-28	487-16-16S	1	-16	1 19/32-20	25.7	(1.01)

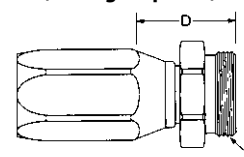
Hose Fitting SAE 100R5
(O-Ring Required)

†Additional dash styles available.

5400 Series

Low Air Inclusion Refrigerant

Component Part Numbers

Item Number	Dash Size→ O.D. Tube Size→	-4 1/4"-3/8"	-8 1/4"-5/8"	-12 5/8"-7/8"	-16 7/8"-13/8"
Typical Male Half					
1	Tubing Adapter	202208-*4	202208-*8	202208-*12	202208-*16
2	Adapter O-ring	22546-12	22546-17	22546-23	22546-28
3	Poppet Valve Assembly	5400-S20-4	5400-S20-8	5400-S20-12	5400-S20-16
4	Male Body	5400-17-4	5400-17-8	5400-17-12	5400-17-16
5	Gasket Seal	22008-4	22008-8	22008-12	22008-16
6	Lock Washer	5400-54-4S	5400-54-8S	5400-54-12S	5400-54-16S
7	Jam Nut	5400-53-4S	5400-53-8S	5400-53-12S	5400-53-16S
Typical Female Half					
8	Union Nut and Body Assembly	5400-S16-4	5400-S16-8	5400-S16-12	5400-S16-16
9	Piston O-Ring	FF91178-10	FF91178-112	FF91178-116	22546-214
10	Female valve assembly	5400-S19-4	5400-S19-8	5400-S19-12	5400-S19-16
2	Adapter O-Ring	22546-12	22546-17	22546-23	22546-28
1	Tubing Adapter	202208-*4	202208-*8	202208-*12	202208-*16

*Specify O.D. Tubing size of adapter required in 16th of an inch. Example: -4 coupling with 3/8" O.D. tubing is 6/16 or -6. Part number is then 202208-6-4.

Couplings for industrial gas application

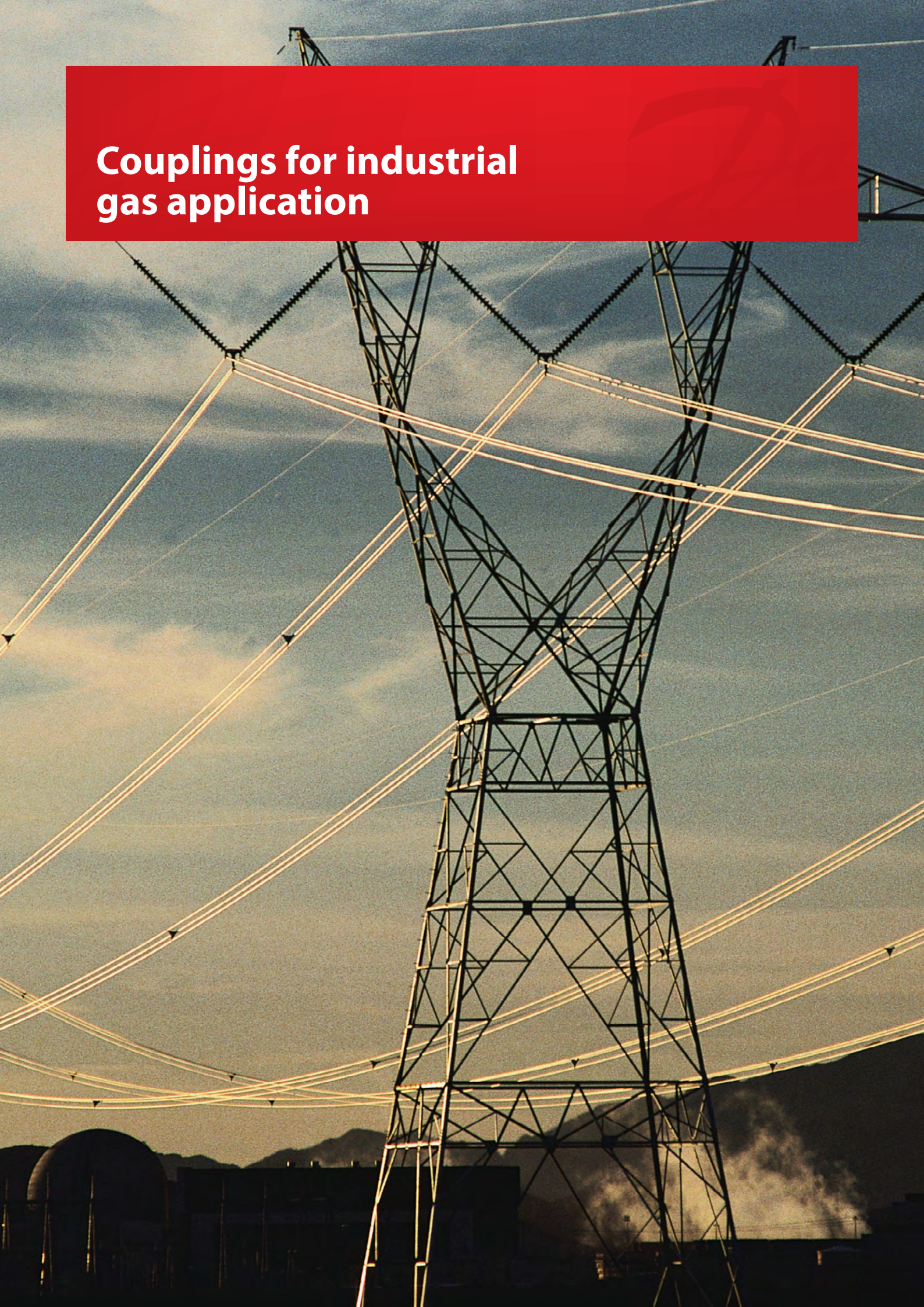

Table of Contents

Thread to connect

LF Series.....	159
600/700 Series.....	161

LF Series

Industrial Gas application



Danfoss Hansen LF series is a specific coupling made for industrial applications using SF6 gas. Its design allows a perfect sealing over several decades and an extremely limited permeation of media into the atmosphere during connection and disconnection, in order to limit global warming. The coupling has a dual O-ring design and dust caps ensuring tight sealing while it is disconnected

Product Features

- Low gas permeation reduces environmental impact
- Connectable under pressure up to 10 bar
- No leakage under Vacuum
- Easy connection and disconnection
- Standard body material: Brass and aluminum
- Standard seal material: EPDM

Physical Characteristics

Body Size	Max operating Pressure		Nominal Flow Diameter	Plug part number	Socket part number	Fluid loss	Air inclusion
(in)	(bar)	(psi)	(mm)			(g)*	(ml)
DN12	15	218	10,2	12LFPS11	12LFSS15	0,02	0,003

*Gas SF6

Applications & Markets

- Industrial application with use of SF6 gas

Flow Data

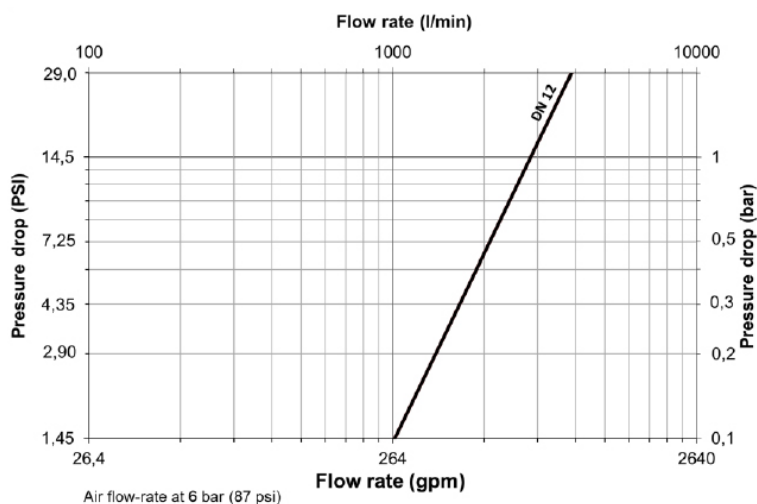

LF Series

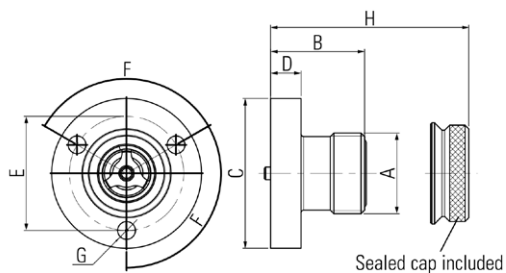

Figure 1

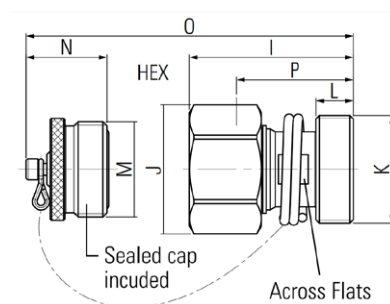

Figure 2

Dimensions

Part number	Fig.	Body Size	Nominal Flow Diameter	Dimensions								Weight	
				A in (mm)	B in (mm)	C in (mm)	D in (mm)	E in (mm)	F (°)	G in (mm)	H in (mm)	lbs	grams
12LFPS11	1	DN 12	10.5	1.260 (M 32 x 2.0)	1.457 (37)	2.32 (59)	0.470 12	1.770 (45)	120°	0.276 (7)	1.594 (40.5)	0.291	132

Part number	Fig.	Body Size	Nominal Flow Diameter	Dimensions								Weight		
				I in (mm)	J in (mm)	Hex in (mm)	K in (mm)	L in (mm)	M in (mm)	N in (mm)	O in (mm)	P in (mm)	lbs	grams
12LFSS14	2	DN 12	10.5	2.126 (54)	1.693 (43)	1.496 (38)	1.417 (M 36 x 2.0)	0.492 (12.5)	1.260 (M 32 x 2.0)	1.024 (26)	2.677 (68)	1.654 (42)	0.816	370

600/700 Series

Industrial Gas application

Danfoss Hansen 600/700 Series quick connect couplings are designed for use in oxyacetylene service. The 600/700 Series can also be used with compressed air and other gases.



Product Features

- Safety sleeve lock prevents accidental disconnections
- Non-Interchangeable design prevents crossing of lines
- Color coded sleeves for easy identification: –600 green, –700 red
- Designed for use with compressed air and other gases
- OSHA compliant
- Standard body material: Brass
- Standard seal material: Buna-N

Physical Characteristics

Series	Body Size	Max. Operating Pressure		Min. Burst Pressure		Rated Flow	
	(in)	(bar)	(psi)	(bar)	(psi)	(lpm)	scfm
600 & 700	1/4	103	1,500	412	6,000	595	21

Applications & Markets

- Breathing Equipment
- Welding
- Shipyards
- General pneumatics
- Construction
- Nitrous Oxide
- Series 600 couplings are not to be used with oxygen at pressures exceeding 100 psig.
- Series 700 couplings are not to be used with acetylene at pressures exceeding 15 psig.

Flow Data

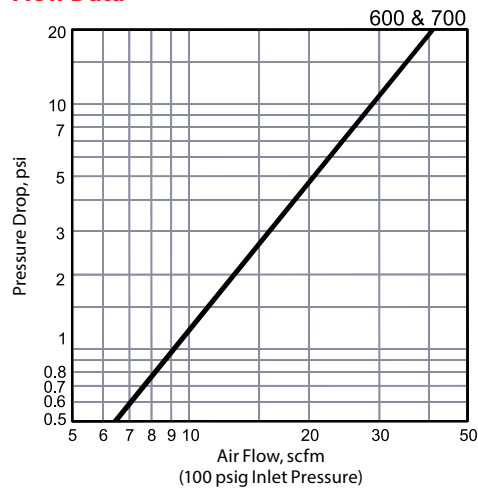

! Series 600 and 700 couplings with sleeve lock feature comply with OSHA requirements*, which state couplings shall be a type that cannot be unlocked or disconnected by means of straight pull without rotary motion.

⚠ WARNING

Oxygen increases combustibility. Fire and explosion could occur causing severe bodily injury or death. Be sure to select the proper coupling for your application and use it only within the specified service pressure range.

*Series 600 and 700 couplings with sleeve lock feature comply with O.S.H.A. requirements, Sec. 1915.35 (f) (5), 1916.35 (f)(5), 1917.35 (f)(5), and 1926.350 (f)(5).

600 Series

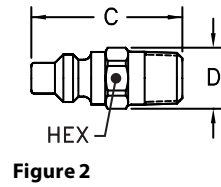
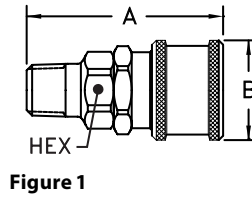

Male End Connections

Part Number Standard*	Oxygen Service	Coupling Type	Body Size	Port Size	Thread	Type	Material	Fig.	Dimensions					
									A (in)	B (in)	Hex (in)	A (mm)	B (mm)	Hex (mm)
GR601	GR601SL	Socket/Female	1/4	1/8	1/8-27	NPTF	Brass	1	1.84	1.00	0.69	46.7	25.4	17.5
GR603	GR603SL	Socket/Female	1/4	1/4	1/4-18	NPTF	Brass	1	2.03	1.00	0.69	51.6	25.4	17.5
GR604R†	GR604RSL	Socket/Female	1/4	9/16	9/16-18	UNF	Brass	1	1.92	1.00	0.69	48.8	25.4	17.5
GR605	GR605SL	Socket/Female	1/4	3/8	3/8-18	NPTF	Brass	1	1.99	1.00	0.69	50.5	25.4	17.5

Part Number Standard*	Oxygen Service	Coupling Type	Body Size	Port Size	Thread	Type	Material	Fig.	Dimensions					
									C (in)	D (in)	Hex (in)	C (mm)	D (mm)	Hex (mm)
01A	—	Plug/Male	1/4	1/8	1/8-27	NPTF	Brass	2	1.41	0.63	0.56	35.8	16.0	14.2
03A	—	Plug/Male	1/4	1/4	1/4-18	NPTF	Brass	2	1.56	0.63	0.56	39.6	16.0	14.2
04R†	—	Plug/Male	1/4	9/16	9/16-18	UNF	Brass	2	1.41	0.63	0.56	35.8	16.0	14.2

†R.H. Thread—30° Female Flare
*Without sleeve lock

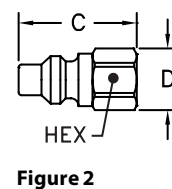
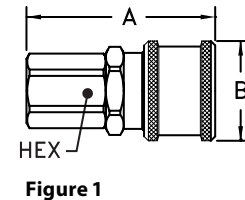

Female End Connections

Part Number Standard*	Oxygen Service	Coupling Type	Body Size	Port Size	Thread	Type	Material	Fig.	Dimensions					
									A (in)	B (in)	Hex (in)	A (mm)	B (mm)	Hex (mm)
GR600	GR600SL	Socket/Female	1/4	1/8	1/8-27	NPTF	Brass	1	1.73	1.00	0.69	43.9	25.4	17.5
GR602	GR602SL	Socket/Female	1/4	1/4	1/4-18	NPTF	Brass	1	1.95	1.00	0.69	49.5	25.4	17.5
GR604	GR604SL	Socket/Female	1/4	3/8	3/8-18	NPTF	Brass	1	2.03	1.00	0.69	51.6	25.4	17.5
GR605R‡	GR605RSL	Socket/Female	1/4	9/16	9/16-18	UNF	Brass	1	1.95	1.00	0.69	49.5	25.4	17.5

Part Number Standard*	Oxygen Service	Coupling Type	Body Size	Port Size	Thread	Type	Material	Fig.	Dimensions					
									C (in)	D (in)	Hex (in)	C (mm)	D (mm)	Hex (mm)
00A	—	Plug/Male	1/4	1/8	1/8-27	NPTF	Brass	2	1.22	0.63	0.56	31.0	16.0	14.2
02A	—	Plug/Male	1/4	1/4	1/4-18	NPTF	Brass	2	1.41	0.77	0.69	35.8	19.6	17.5
05R‡	—	Plug/Male	1/4	9/16	9/16-18	UNF	Brass	2	1.38	0.77	0.69	35.1	19.6	17.5

‡R.H. Thread—Inverted Flare
*Without sleeve lock

600 Series

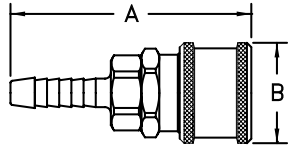

Figure 1

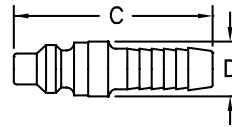
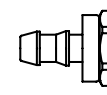
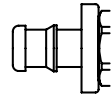

Figure 2



GR606P
Figure 1A



GR608P

Hose Stem End Connections

Part Number Standard*	Oxygen Service	Coupling Type	Body Size	Hose I.D.	Material	Fig.	Dimensions			
							A (in)	B (in)	A (mm)	B (mm)
GR606	GR606SL	Socket/Female	1/4	1/4	Brass	1	2.47	1.00	62.74	25.40
GR606P\$	GR606PSL\$	Socket/Female	1/4	1/4	Brass	1, 1A	2.24	1.00	56.90	25.40
GR607	GR607SL	Socket/Female	1/4	5/16	Brass	1	2.47	1.00	62.74	25.40
GR608	GR608SL	Socket/Female	1/4	3/8	Brass	1	2.47	1.00	62.74	25.40
GR608P\$	—	Socket/Female	1/4	3/8	Brass	1, 1A	2.31	1.00	58.67	25.40

Part Number Standard*	Oxygen Service	Coupling Type	Body Size	Hose I.D.	Material	Fig.	Dimensions			
							C (in)	D (in)	C (mm)	D (mm)
07A	—	Plug/Male	1/4	1/4	Brass	2	2.03	0.56	51.56	14.22
08A	—	Plug/Male	1/4	5/16	Brass	2	2.03	0.56	51.56	14.22
09A	—	Plug/Male	1/4	3/8	Brass	2	2.04	0.56	51.82	14.22

\$For use with push-on style hose
*Without sleeve lock

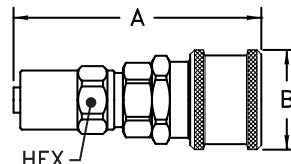

Figure 1

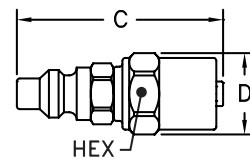

Figure 2

Hose Clamp End Connections

Part Number Standard*	Oxygen Service	Coupling Type	Body Size	Hose I.D.	Hose O.D.	Material	Fig.	Dimensions					
								A (in)	B (in)	Hex (in)	A (mm)	B (mm)	Hex (mm)
GR60B3	GR60B3SL	Socket/Female	1/4	1/4	1/2	Brass	1	2.56	1.00	0.63	65.0	25.4	16.0
GR60B5	GR60B5SL	Socket/Female	1/4	1/4	9/16	Brass	1	2.56	1.00	0.69	65.0	25.4	17.5
GR60B7	GR60B7SL	Socket/Female	1/4	1/4	5/8	Brass	1	2.56	1.00	0.75	65.0	25.4	19.1
GR60C5	—	Socket/Female	1/4	5/16	9/16	Brass	1	2.62	1.00	0.69	66.5	25.4	17.5
GR60D7	—	Socket/Female	1/4	3/8	5/8	Brass	1	2.68	1.00	0.75	68.1	25.4	19.1
GR60D9	—	Socket/Female	1/4	3/8	11/16	Brass	1	2.68	1.00	0.81	68.1	25.4	20.6
GR60D11	—	Socket/Female	1/4	3/8	3/4	Brass	1	2.68	1.00	0.88	68.1	25.4	22.4

Part Number Standard*	Oxygen Service	Coupling Type	Body Size	Hose I.D.	Hose O.D.	Material	Fig.	Dimensions					
								C (in)	D (in)	Hex (in)	C (mm)	D (mm)	Hex (mm)
6B3	—	Plug/Male	1/4	1/4	1/2	Brass	2	2.13	0.70	0.63	54.1	17.8	16.0
6B5	—	Plug/Male	1/4	1/4	9/16	Brass	2	2.13	0.77	0.69	54.1	19.6	17.5
6B7	—	Plug/Male	1/4	1/4	5/8	Brass	2	2.13	0.84	0.75	54.1	21.3	19.1
6D7	—	Plug/Male	1/4	3/8	5/8	Brass	2	2.25	0.84	0.75	57.2	21.3	19.1
6D9	—	Plug/Male	1/4	3/8	11/16	Brass	2	2.25	0.91	0.81	57.2	23.1	20.6
6D11	—	Plug/Male	1/4	3/8	3/4	Brass	2	2.25	0.98	0.88	57.2	24.9	22.4

*Without sleeve lock

700 Series

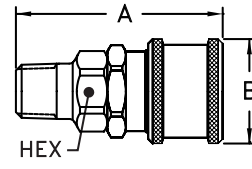

Figure 1

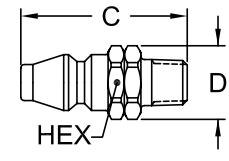

Figure 2

Male End Connections

Part Number Standard*	Acetylene Service	Coupling Type	Body Size	Port Size	Thread	Type	Material	Fig.	Dimensions					
									A	B	Hex	A	B	Hex
									(in)	(in)	(in)	(mm)	(mm)	(mm)
RD701	—	Socket/Female	1/4	1/8	1/8-27	NPTF	Brass	1	1.85	1.00	0.69	47.0	25.4	17.5
RD703	RD703SL	Socket/Female	1/4	1/4	1/4-18	NPTF	Brass	1	2.04	1.00	0.69	51.8	25.4	17.5
RD704L†	RD704LSL	Socket/Female	1/4	9/16	9/16-18	UNF	Brass	1	1.93	1.00	0.69	49.0	25.4	17.5
RD705	RD705SL	Socket/Female	1/4	3/8	3/8-18	NPTF	Brass	1	2.00	1.00	0.69	50.8	25.4	17.5

Part Number Standard*	Acetylene Service	Coupling Type	Body Size	Port Size	Thread	Type	Material	Fig.	Dimensions					
									C	D	Hex	C	D	Hex
									(in)	(in)	(in)	(mm)	(mm)	(mm)
A1	—	Plug/Male	1/4	1/8	1/8-27	NPTF	Brass	2	1.47	0.63	0.56	37.3	16.0	14.2
A3P	—	Plug/Male	1/4	1/4	1/4-18	NPTF	Brass	2	1.63	0.63	0.56	41.4	16.0	14.2
A4L†	—	Plug/Male	1/4	9/16	9/16-18	UNF	Brass	2	1.50	0.63	0.56	38.1	16.0	14.2

†L.H. Thread—30° Female Flare

*Without sleeve lock

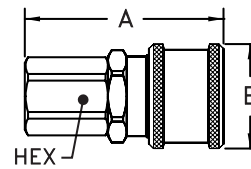

Figure 1

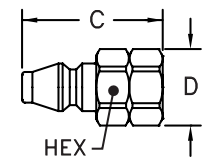

Figure 2

Female End Connections

Part Number Standard*	Acetylene Service	Coupling Type	Body Size	Port Size	Thread	Type	Material	Fig.	Dimensions					
									A	B	Hex	A	B	Hex
									(in)	(in)	(in)	(mm)	(mm)	(mm)
RD700	RD700SL	Socket/Female	1/4	1/8	1/8-27	NPTF	Brass	1	1.74	1.00	0.69	44.2	25.4	17.5
RD702	RD702SL	Socket/Female	1/4	1/4	1/4-18	NPTF	Brass	1	1.96	1.00	0.69	49.8	25.4	17.5
RD704	RD704SL	Socket/Female	1/4	3/8	3/8-18	NPTF	Brass	1	2.04	1.00	0.69	51.8	25.4	17.5
RD705L‡	RD705LSL	Socket/Female	1/4	9/16	9/16-18	UNF	Brass	1	1.96	1.00	0.69	49.8	25.4	17.5

Part Number Standard*	Acetylene Service	Coupling Type	Body Size	Port Size	Thread	Type	Material	Fig.	Dimensions					
									C	D	Hex	C	D	Hex
									(in)	(in)	(in)	(mm)	(mm)	(mm)
A2	—	Plug/Male	1/4		1/4-18	NPTF	Brass	2	1.46	0.77	0.69	37.1	19.6	17.5
A5L‡	—	Plug/Male	1/4		9/16-18	UNF	Brass	2	1.38	0.77	0.69	35.1	19.6	17.5

‡L.H. Thread—Inverted Flare

*Without sleeve lock

700 Series

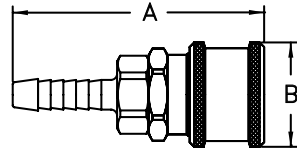

Figure 1

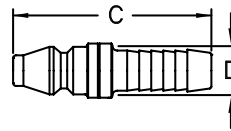
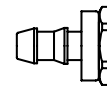
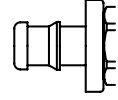

Figure 2



RD706P
Figure 1A



RD708P

Hose Stem End Connections

Part Number	Acetylene Service	Coupling Type	Body Size	Hose I.D.	Material	Fig.	Dimensions			
Standard*							A	B	A	B
							(in)	(in)	(mm)	(mm)
RD706	RD706SL	Socket/Female	1/4	1/4	Brass	1	2.48	1.00	63.0	25.4
RD706P ^S	—	Socket/Female	1/4	1/4	Brass	1	2.25	1.00	57.2	25.4
RD707	RD707SL	Socket/Female	1/4	5/16	Brass	1	2.48	1.00	63.0	25.4
RD708	RD708SL	Socket/Female	1/4	3/8	Brass	1	2.48	1.00	63.0	25.4
RD708P	—	Socket/Female	1/4	3/8	Brass	1	2.32	1.00	58.9	25.4

Part Number	Acetylene Service	Coupling Type	Body Size	Hose I.D.	Material	Fig.	Dimensions			
Standard*							C	D	C	D
							(in)	(in)	(mm)	(mm)
A7	—	Plug/Male	1/4	1/4	Brass	2	2.00	0.56	50.8	14.2
A8	—	Plug/Male	1/4	5/16	Brass	2	2.06	0.56	52.3	14.2
A9	—	Plug/Male	1/4	3/8	Brass	2	2.10	0.56	53.3	14.2

^SFor use with push-on style hose
*Without sleeve lock

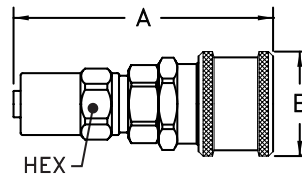

Figure 1

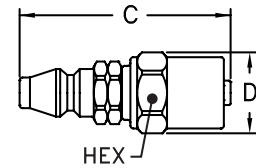

Figure 2

Hose Clamp End Connections

Part Number	Acetylene Service	Coupling Type	Body Size	Hose I.D.	Hose O.D.	Material	Fig.	Dimensions			Hex	A	B	Hex
Standard*								A	B	Hex	A	B	Hex	
								(in)	(in)	(in)	(mm)	(mm)	(mm)	
RD70B3	RD70B3SL	Socket	1/4	1/4	1/2	Brass	1	2.57	1.00	0.63	65.3	25.4	16.0	
RD70B7	—	Socket	1/4	1/4	5/8	Brass	1	2.57	1.00	0.75	65.3	25.4	19.1	
RD70D7	—	Socket	1/4	3/8	5/8	Brass	1	2.69	1.00	0.75	68.3	25.4	19.1	
RD70D9	—	Socket	1/4	3/8	11/16	Brass	1	2.69	1.00	0.81	68.3	25.4	20.6	

Part Number	Acetylene Service	Coupling Type	Body Size	Hose I.D.	Hose O.D.	Material	Fig.	Dimensions			Hex	C	D	Hex
Standard*								C	D	Hex	C	D	Hex	
								(in)	(in)	(in)	(mm)	(mm)	(mm)	
7B3	—	Plug	1/4	1/4	1/2	Brass	2	2.19	0.70	0.63	55.6	17.8	16.0	
7B7	—	Plug	1/4	1/4	5/8	Brass	2	2.19	0.84	0.75	55.6	21.3	19.1	

*Without sleeve lock

Dust Caps and Dust Plugs

Series	Dust Cap	Dust Plug
600	XPPDC1HK	XPSDC1HK
700	XPPDC1HK	XPSDC1HK



Couplings for food & beverage applications



Table of Contents

Push to connect

2HKGL Series.....	168
-------------------	-----

2HKGL Series

Food&Beverage application



Danfoss Hansen 2HKGL series is a specific coupling made for liquid or gas transfer in various field, such as chemical, food and beverage, or aerospace. The coupling is a push/pull and the material used is stainless steel. This series was made based on the 2HKIL/2HKIG Danfoss Hansen series. The socket part has 3 locking balls.

Product Features

- Specific series made from 2HKIL/2HKIG
- Size 1/4"
- Specific application
- Stainless steel construction

Physical Characteristics

Body Size	Max. Operating Pressure		Min. burst Pressure		Nominal Flow Diameter	Rated Flow		Air Inclusion	Fluid Loss
(in)	(bar)	(psi)	(bar)	(psi)	(mm)	(lpm)	(gpm)	cc. max.	cc. max.
1/4	110	1595	438	6352	5.9	8,3	2,2	2,2	1

Applications & Markets

- Food and beverage
- Military
- Aerospace
- Chemical

Flow Data

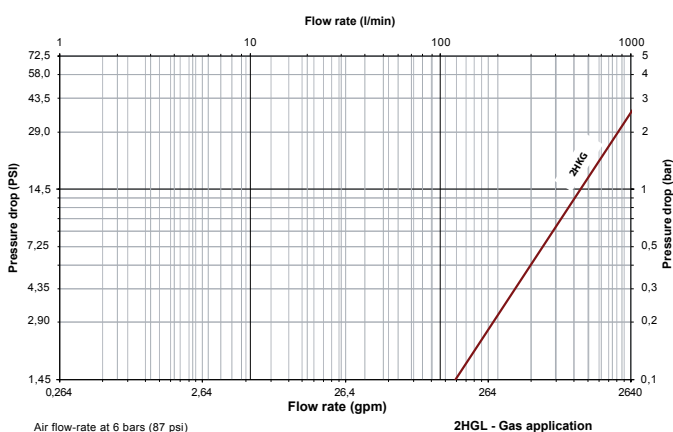

This flow chart applies for products for gas application, which include "HG" or "KG" letters in their part numbers.

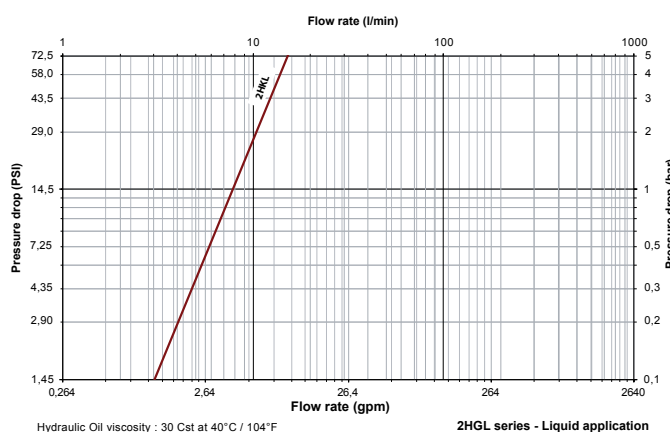

This flow chart applies for products for liquid application, which include "HL" or "KL" letters in their part numbers.

Seal Elastomer Data*

Seal Elastomer**	Max. Operation Temperature Range
EPDM (Ethylene-Propylene)*	-40°C +150°C/-40°F +302°F

*For reference only, based on Danfoss recommended temperatures.
Contact Danfoss technical support for further information on fluid compatibility

2HKGL Series

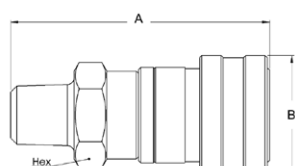
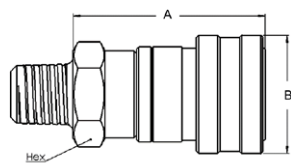

End-connections

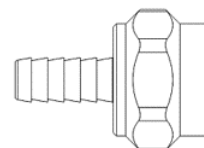
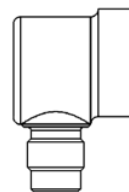
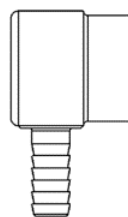

Figure 1

Figure 2

Figure 3

Figure 4

Figure 5

Dimensions

Part Number	Body Size (in)	End connection			Fig	Socket dimensions					
		UNF	NPT	Hosebarb		A (mm)	B (mm)	Hex (mm)	A (in)	B (in)	Hex (in)
2HGRB	1/4	-	-	1/4	3	54,8	41,9	-	2.16	1.65	-
2HLRB	1/4	-	-	1/4	3	54,8	41,9	-	2.16	1.65	-
2HGLLRA720	1/4	7/16-20	-	-	4	53,3	36,3	-	2.10	1.43	-
2HLLRA720	1/4	7/16-20	-	-	4	53,3	36,3	-	2.10	1.43	-
2HGBNB	1/4	-	-	1/4	5	69,3	25,4	-	2.73	1.00	-
2HLBNB	1/4	-	-	1/4	5	41,6	21,0	-	1.64	0.83	-
2HGDNB	1/4	-	-	3/8	5	69,3	25,4	-	2.73	1.00	-
2HLBNB	1/4	-	-	3/8	5	41,6	21,0	-	1.64	0.83	-
2HG720	1/4	7/16-20	-	-	1	54,8	41,91	20,57	2.16	1.65	0.81
2HL720	1/4	7/16-20	-	-	1	71,1	25,4	20,57	2.80	1.00	0.81
2HG15	1/4	-	1/4	-	1	69,3	25,4	20,57	2.73	1.00	0.81
2HL15	1/4	-	1/4	-	1	40,6	21,08	20,57	1.60	0.83	0.81
2HG20	1/4	-	3/8	-	1	69,3	25,4	20,57	2.73	1.00	0.81
2HL20	1/4	-	3/8	-	1	71,1	25,4	20,57	2.80	1.00	0.81
2HG16	1/4	-	1/4	-	2	69,3	25,4	20,57	2.73	1.00	0.81
2HL16	1/4	-	1/4	-	2	54,8	27,68	20,57	2.16	1.09	0.81

2HKGL Series

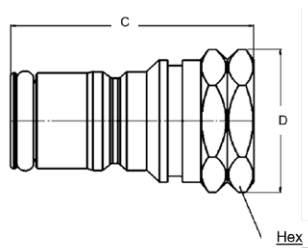

Figure 6

End-connections

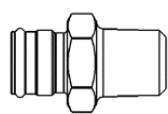

Figure 7

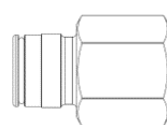

Figure 8

Dimensions

Part Number	Body Size (in)	End connection		Fig	Plug dimensions					
		UNF	NPT		C (mm)	D (mm)	Hex (mm)	C (in)	D (in)	Hex (in)
2KGF16	1/4	-	1/4	8	50,29	25,4	22,35	1,98	1,00	0,88
2KLF16	1/4	-	1/4	8	46,22	22,8	22,35	1,82	0,90	0,88
2KLF720	1/4	7/16-20	-	8	40,64	22,8	22,35	1,60	0,90	0,88
2KGF15	1/4	-	1/4	7	29,71	25,4	22,35	1,17	1,00	0,88
2KLF15	1/4	-	1/4	7	50,8	24,1	22,35	2,00	0,95	0,88
2KGF20	1/4	-	3/8	7	50,03	24,1	22,35	1,97	0,95	0,88
2KLF20	1/4	-	3/8	7	50,29	25,4	22,35	1,98	1,00	0,88
2KGC	1/4	11/16-18	-	6	37,08	20,3	20,57	1,46	0,80	0,81
2KLC	1/4	11/16-18	-	6	37,08	25,4	22,35	1,46	1,00	0,88
2KLS3	1/4	7/16-20	-	6	36,83	19,5	21,84	1,45	0,75	0,86
2KLS4	1/4	7/16-20	-	6	38,1	19,5	21,84	1,50	0,75	0,86

Couplings for pneumatic applications

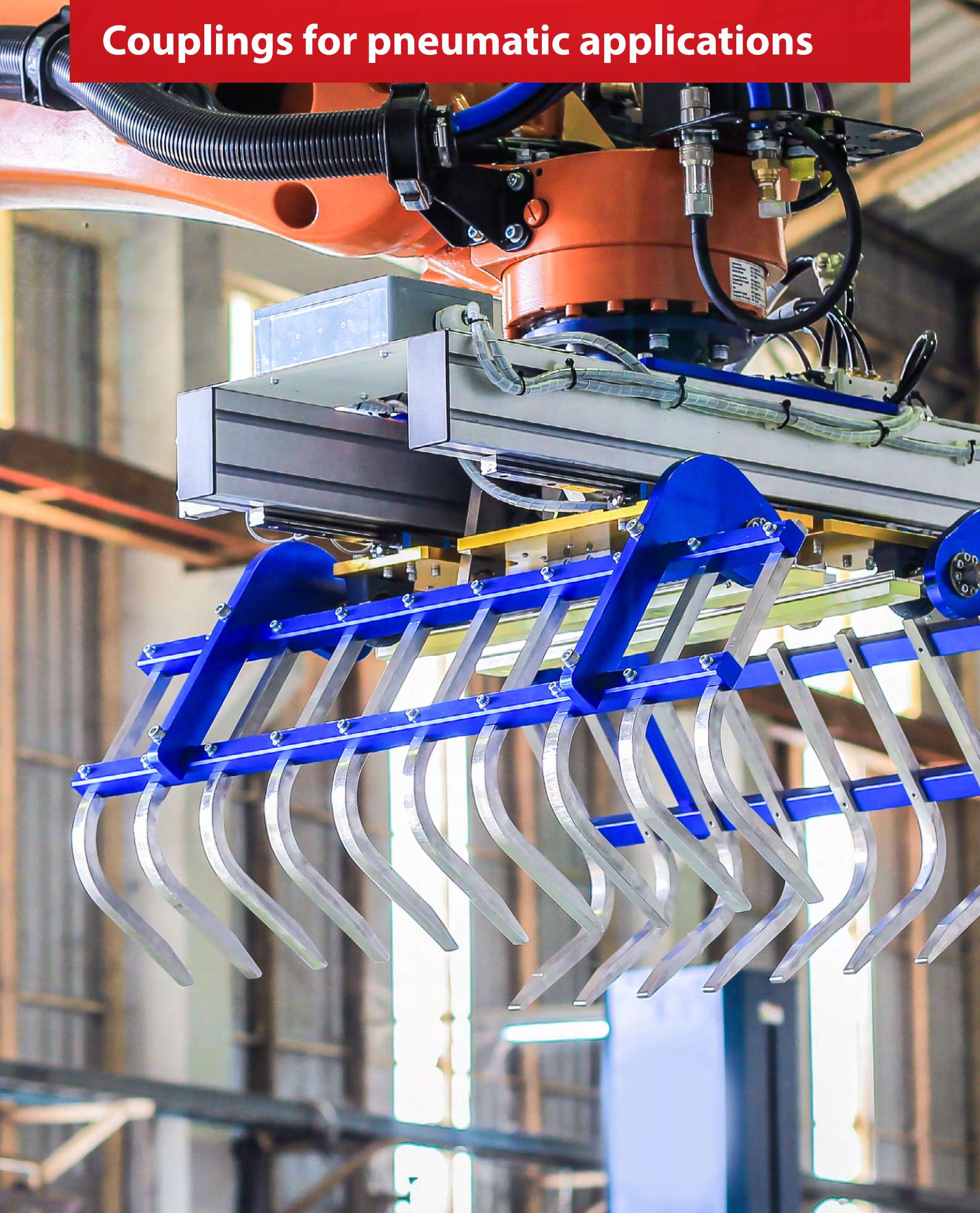

Table of Contents

Push button	
Safeline Series	175
Ball latch	
1000/400/500 Series	186
G600/I900/T1100/T1300 Series	194
Push to connect	
3000/4000/5000/6000 Series	203
AutoFlo23/24 Series	213
210/310 Series	217
100 Series	220
180/280 Series	222
Full Bore Series	224
Gas-mate Series	226
Push to connect with ring lock sleeve	
2RL/3RL Series	228
Accessory	
Flex-Air Series	233
Blowguns	235
Adapters	236

Pneumatic Couplings Selector Chart

Coupling Series	Coupling Style			Interchange				Body Size					Body Material				Locking Mechanism			Options					
	MANUAL CONNECT	PUSH-TO-CONNECT	SAFETY COUPLING	ISO 6150 B	ISO 6150 C	ARO 210/310	TRU-FLATE	CEJN 320/RECTUS 25	PROPRIETARY PROFILE	1/8 INCH	1/4 INCH	3/8 INCH	1/2 INCH	3/4 INCH	ALUMINUM	BRASS	STEEL (Zinc/chromate Finish)	STAINLESS STEEL	PLASTIC (Acetal)	BALL LOCK	PIN LOCK	RING LOCK	PLASTIC FINGERS	SLEEVE LOCK	SEAL MATERIALS (Various)
G600		●		●						●					●				●						
I900		●		●							●				●				●						
T1100		●		●								●			●				●						
T1300		●						●				●			●				●						
1000	●			●						●					●		●		●				●	●	●
400	●			●			●				●				●				●				●	●	●
500	●			●								●			●				●				●	●	
3000		●		●						●					●					●			●	●	●
4000		●		●							●				●					●			●	●	●
5000		●		●								●			●					●			●	●	
6000		●		●									●		●					●			●	●	
Auto-Flo 23		●		●		●	●			●					●				●						
Auto-Flo 24		●						●		●					●				●						
Safeline		●	●	●	●					●				●		●			●						
180/280	●							●	●						●				●					●	
100	●							●	●	●					●				●					●	●
600/700	●							●		●					●				●				●		●
2RL		●						●		●						●					●			●	●
3RL		●						●			●					●					●			●	●
Full-Bore		●	●	●							●	●				●			●						
210		●				●				●						●				●					
310		●				●					●					●				●					

Safeline Series

Operation Guidelines

Elimination of hose whip with two distinct movements:

- 1 Button pressed  Dissipation of downstream pressure: the plug is retained in the socket
- 2 Plug pushed into the socket  Disconnection

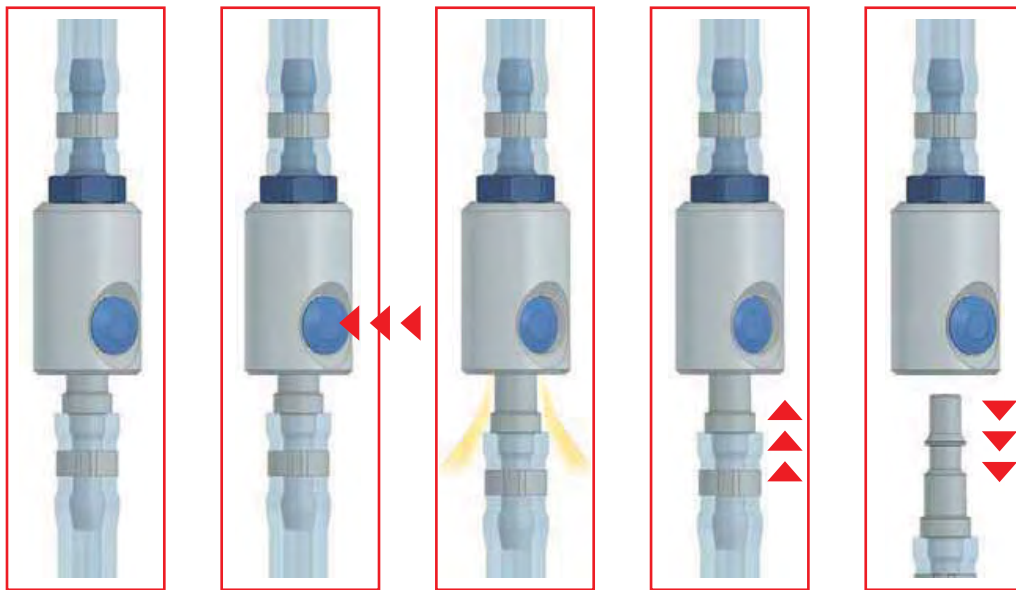

Coupling connected

The button is pressed

The plug is retained in the socket: dissipation of downstream pressure

The plug is pushed toward the socket

Disconnection

Recommendation applicable to all profiles

Use with vibrating tools:
A flexible hose at least 300 mm long between the tool and the quick coupling is recommended.

Safeline Series

ISO 6150 B GD10500

Safety-Type Quick-Release

Pneumatic application

Danfoss' Safeline Series is an Industrial Interchange pneumatic coupling with push button safety feature designed for use with compressed air. Two-step disconnect procedure shuts off air supply and releases downstream air pressure before plug can be removed from socket/female, which prevents hose whip.



Product Features

- Safe and easy to connect and disconnect
- Light weight, compact ergonomic design
- Accepts 1/4" ISO 6150 Series B and A-A-59439 plugs/males
- Accepts all US industrial plugs/males
- Standard body material: Aluminum
- Standard seal material: Buna-N
- Option: Private labelling

Physical Characteristics

Body Size	Nominal Flow Diameter	Max. Operating Pressure Connected or Disconnected		Air Flow Rate* Δp 0.6 bar/8.7 psi**		Δp 1 bar/14.5 psi***		Working Temperature	
		(bar)	(psi)	(lpm)	(gpm)	(lpm)	(gpm)	°C	°F
1/4	5.5	16	232	525	139	660	174	-20° +100°	-4° +212°

*Indicated values refer to an inlet pressure of 6 bar / 87 psi.

**This flow rate allows the optimum output from a pneumatic tool.

*** This flow rate is the maximum recommended for a suitable output from a pneumatic tool. For applications needing higher flow rates, it is recommended to select a larger size coupling.

Applications & Markets

- General Pneumatics
- Air Tools
- Industrial Plants
- Maintenance and Repair

Flow Data

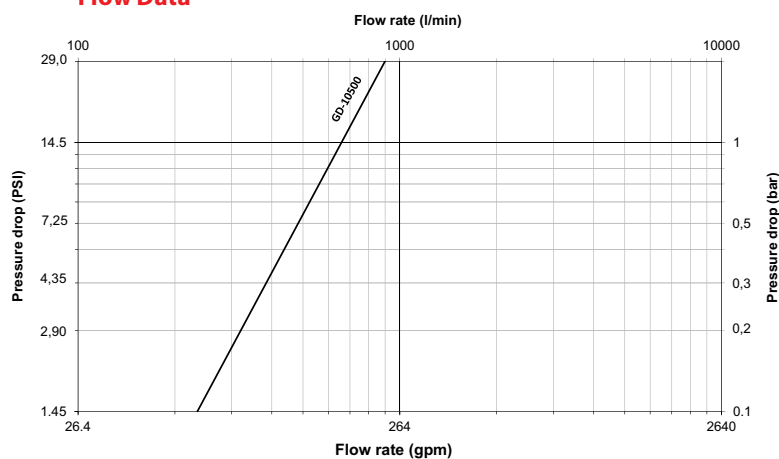

Air flow-rate at 6 bar (87 psi)

Safeline Series

ISO 6150 B GD10500 Safety-Type Quick-Release

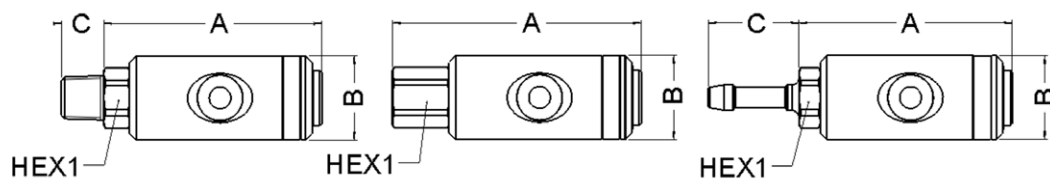

Figure 1

Figure 2

Figure 3

Sockets (Female)

Part Number	Body Size	Port Size	Thread or Hose Diam.	Type	Fig.	Dimensions				A	B	C	Hex1	Weight	
						A	B	C	Hex1						
						(in)	(in)	(in)	(in)	(mm)	(mm)	(mm)	(mm)	(lbs)	(g)
GD1053615		¼	¼	Male BSPP	1	2.57	1.02	0.48	0.75	65.3	26.0	12.2	19	0.23	106
GD1053614		¼	¼	Male BSPT	1	2.65	1.02	0.51	0.67	67.3	26.0	13.0	17	0.23	105
GD1053641		¼	¼	Male NPT	1	2.65	1.02	0.59	0.67	67.2	26.0	15.1	17	0.26	118
GD1053639		¾	¾	Male BSPP	1	2.61	1.02	0.47	0.87	66.3	26.0	12.0	22	0.26	116
GD1053638		¾	¾	Male BSPT	1	2.65	1.02	0.57	0.67	67.3	26.0	14.5	17	0.25	113
GD1053683		¾	¾	Male NPT	1	2.62	1.02	0.60	0.75	66.5	26.0	15.3	19	0.28	129
GD1053613		½	½	Male BSPP	1	2.69	1.02	0.55	1.06	68.3	26.0	14.0	27	0.32	145
GD1053612		½	½	Male BSPT	1	2.61	1.02	0.67	0.87	66.3	26.0	17.0	22	0.28	129
GD1053621		½	½	Male NPT	1	2.61	1.02	0.79	0.87	66.3	26.0	20.0	22	0.32	145
GD1052614	¼	¼	¼	Female BSPP	2	2.33	1.02	0.00	0.67	76.8	26.0	-	17	0.23	105
GD1052641		¼	¼	Female NPT	2	2.33	1.02	0.00	0.67	76.3	26.0	-	17	0.23	105
GD1052638		¾	¾	Female BSPP	2	3.14	1.02	0.00	0.87	79.8	26.0	-	22	0.27	124
GD1052683		¾	¾	Female NPT	2	3.08	1.02	0.00	0.87	78.3	26.0	-	22	0.27	123
GD1052612		½	½	Female BSPP	2	3.30	1.02	0.00	1.06	83.8	26.0	-	27	0.33	151
GD1052621		½	½	Female NPT	2	3.24	1.02	0.00	1.06	82.3	26.0	-	27	0.37	166
GD1055667	-	-	6 mm	Reusable Hose Fit.	3	2.59	1.02	1.10	0.67	65.8	26.0	28.0	17	0.23	103
GD1055678	-	-	7 mm	Reusable Hose Fit.	3	2.59	1.02	1.10	0.67	65.8	26.0	28.0	17	0.25	113
GD1055689	-	-	8 mm	Reusable Hose Fit.	3	2.59	1.02	1.10	0.67	65.8	26.0	28.0	17	0.23	104
GD1055690	-	-	9 mm	Reusable Hose Fit.	3	2.59	1.02	1.10	0.67	65.8	26.0	28.0	17	0.23	106
GD1055601	-	-	10 mm	Reusable Hose Fit.	3	2.59	1.02	1.10	0.67	65.8	26.0	28.0	17	0.23	105

To obtain connected length of coupling add Dimensions A or A+C (Fig. 1, 2, 3) and D or D+E (Fig. 4, 5, 6, 7, 8) together and subtract 23 mm (0,91 in).

*Alternative end connections available upon request.

Safeline Series

ISO 6150 B GD10500 Safety-Type Quick-Release

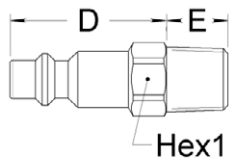

Figure 4

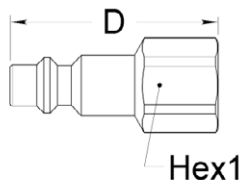

Figure 5

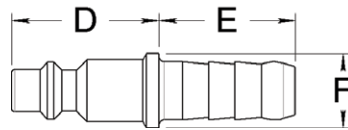

Figure 6

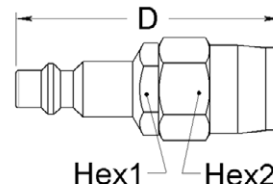

Figure 7

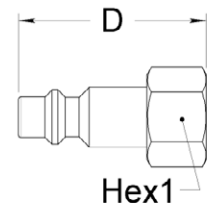

Figure 8

Plugs (Male)

Part Number	Body Size	Port Size	Thread or Hose Diam.	Type	Fig.	Dimensions			Hex1 (in)	Hex2 (in)	D (mm)	E (mm)	F (mm)	Hex1 (mm)	Hex2 (mm)	Weight	
						D (in)	E (in)	F (in)								(lbs)	(g)
GA0066318		1/8	1/8-28	Male BSPT	4	1.260	0.354	-	0.472	-	32	9	-	12	-	0.04189	19
GA0066314		1/4	1/4-19	Male BSPT	4	1.260	0.512	-	0.551	-	32	13	-	14	-	0.06	25
10		1/4	1/4-18	Male NPT	4	1.220	0.551	-	0.591	-	31	14	-	15	-	0.06	25
GA0066338		3/8	3/8-19	Male BSPT	4	1.260	0.591	-	0.669	-	32	15	-	17	-	0.08	38
GA0066345		M14	M14x125	Male Metric	4	1.260	0.512	-	0.551	-	32	13	-	14	-	0.06	26
GA0066214		1/4	1/4-19	Female BSPP	5	1.732	-	-	0.669	-	44	-	-	17	-	0.07	30
11		1/4	1/4-18	Female NPT	5	1.634	-	-	0.709	-	41.5	-	-	18	-	0.07	30
GA0066238		3/8	3/8-19	Female BSPP	5	1.732	-	-	0.827	-	44	-	-	21	-	0.08	37
GA0066245		M14	M14x125	Female Metric	5	1.732	-	-	0.669	-	44	-	-	17	-	0.06	26
GA0066248	1/4	-	M14x125	Female Metric	5	1.732	-	-	0.551	-	44	-	-	14	-	0.05	24
GA0066767		-	6mm	Hose Tail	6	1.102	1.024	0.551	-	-	28	26	14	-	-	0.04	19
GA0066778		-	7mm	Hose Tail	6	1.102	1.024	0.551	-	-	28	26	14	-	-	0.04	20
GA0066789		-	8mm	Hose Tail	6	1.102	1.024	0.551	-	-	28	26	14	-	-	0.04	20
GA0066790		-	9mm	Hose Tail	6	1.102	1.024	0.551	-	-	28	26	14	-	-	0.04	20
GA0066701		-	10mm	Hose Tail	6	1.102	1.024	0.551	-	-	28	26	14	-	-	0.05	22
GA0066174		-	7x14 mm	Reusable Hose Fit.	7	2.224	-	-	0.630	0.748	56.5	-	-	16	19	0.12	56
GA0066184		-	8x14 mm	Reusable Hose Fit.	7	2.224	-	-	0.630	0.748	56.5	-	-	16	19	0.13	57
GA0066185		-	8x15 mm	Reusable Hose Fit.	7	2.224	-	-	0.630	0.748	56.5	-	-	16	19	0.12	53
GA0066196		-	9x16 mm	Reusable Hose Fit.	7	2.224	-	-	0.630	0.748	56.5	-	-	16	19	0.11	51
GA0066814		1/4	1/4-19	Female BSPP Swivel	8	1.496	-	-	0.669	-	38	-	-	17	-	0.06	26
GA0066845		M14	M14x125	Female Metric Swivel	8	1.496	-	-	0.669	-	38	-	-	17	-	0.06	26

To obtain connected length of coupling add Dimensions A or A+C (Fig. 1, 2, 3) and D or D+E (Fig. 4, 5, 6, 7, 8) together and subtract 23 mm (0,91 in).

*Alternative end connections available upon request.

Safeline Series

ISO 6150 B ID10900

Safety-Type Quick-Release

Pneumatic application

Danfoss ID10900 Series is a single shut-off compressed air coupling that interchanges with ISO 6150 C Standards requirements. Nominal diameter is 8 mm. Thanks to a distinct two-movement action, our couplings guarantee worker safety at disconnection by eliminating the “whiplash” effect. It is a must-have for safe air applications.

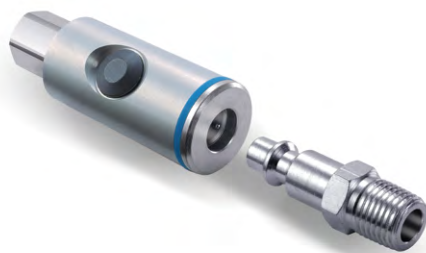

Product Features

- One-hand push-to-connect
- Automatic button for disconnection
- Meets safety standard ISO 4414
- Single shut-off valving
- Good flow capacity
- Wide selection of end connections
- Standard seal material: NBR (Nitrile)
- Standard body material (Female): Aluminum
- Standard body material (Male): Zinc plated steel
- Option: Private labelling

Physical Characteristics

Body Size	Nominal Flow Diameter (mm)	Max. Operating Pressure Connected or Disconnected		Air Flow Rate* Δp 0.6 bar/8.7 psi**			Working Temperature		
		(bar)	(psi)	(lpm)	(gpm)	(lpm)	(gpm)	°C	°F
3/8	8	16	232	1,590	420	2,000	528	-20° +100°	-4° +212°

*Indicated values refer to an inlet pressure of 6 bar / 87 psi.

**This flow rate allows the optimum output from a pneumatic tool.

** This flow rate is the maximum recommended for a suitable output from a pneumatic tool. For applications needing higher flow rates, it is recommended to select a larger size coupling.

Applications & Markets

- General Pneumatics
- Air Tools

Flow Data

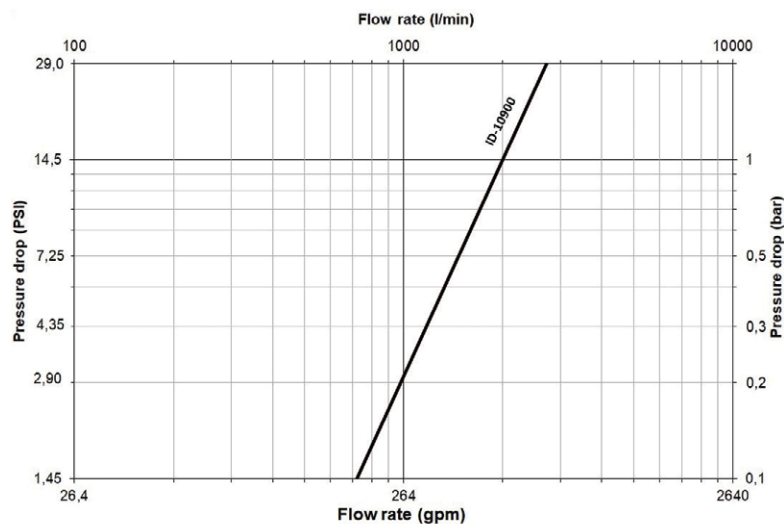

Air Flow-rate at 6 bar (87psi)

Safeline Series

ISO 6150 B ID10900
Safety-Type Quick-Release

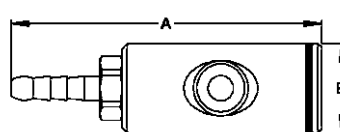
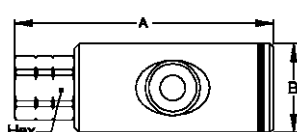
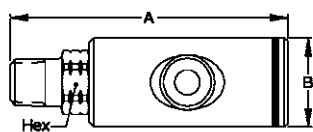

Figure 1

Figure 2

Figure 3

Sockets (Female)

Part Number	Body Size	Port Size	Thread or Hose Diam.	Type	Fig.	Dimensions							Weight		
						A	B	C	Hex1	A	B	C	Hex1	(lbs)	(g)
						(in)	(in)	(in)	(in)	(mm)	(mm)	(mm)	(mm)		
ID1096015		¼	¼	Male BSPP	1	3.0	1.3	0.5	0.87	76.2	34	11.9	22	0.47	214
ID1096014		¼	¼	Male BSPT	1	3.0	1.3	0.5	0.87	76.1	34	13	22	0.47	213
ID1096041		¼	¼	Male NPT	1	3.0	1.3	0.5	0.87	76	34	13	22	0.47	213
ID1096039		¾	¾	Male BSPP	1	3.0	1.3	0.5	0.87	76.20	34	11.9	22	0.48	218
ID1096038		¾	¾	Male BSPT	1	3.0	1.3	0.6	0.87	76.1	34	15	22	0.48	219
ID1096083		¾	¾	Male NPT	1	3.0	1.3	0.6	0.87	76.1	34	15	22	0.48	219
ID1096013		½	½	Male BSPP	1	3.0	1.3	0.5	1.06	76.2	34	13.9	27	0.52	238
ID1096012		½	½	Male BSPT	1	3.0	1.3	0.7	0.87	76.1	34	17	22	0.51	233
ID1096021		½	½	Male NPT	1	3.0	1.3	0.7	0.87	76.1	34	17	22	0.51	233
ID1097014	¾	¼	¼	Female BSPP	2	3.5	1.3	-	0.87	88.1	34	-	22	0.51	233
ID1097041		¼	¼	Female NPT	2	3.5	1.3	-	0.87	88.10	34	-	22	0.51	233
ID1097038		¾	¾	Female BSPP	2	3.6	1.3	-	0.87	90.60	34	-	22	0.51	232
ID1097083		¾	¾	Female NPT	2	3.6	1.3	-	0.87	90.6	34	-	22	0.51	232
ID1097012		½	½	Female BSPP	2	3.7	1.3	-	1.06	94.1	34	-	27	0.59	267
ID1097021		½	½	Female NPT	2	3.7	1.3	-	1.06	94.1	34	-	27	0.59	269
ID1095678	-		7 mm	Hose Tail	3	3.0	1.3	1.1	0.87	77.1	34	28	22	0.47	215
ID1095689	-		8 mm	Hose Tail	3	3.0	1.3	1.1	0.87	77.1	34	28	22	0.48	216
ID1095690	-		9 mm	Hose Tail	3	3.0	1.3	1.1	0.87	77.1	34	28	22	0.48	218
ID1095601	-		10 mm	Hose Tail	3	3.0	1.3	1.1	0.87	77.1	34	28	22	0.48	219

To obtain connected length of coupling add dimensions A or A+C (Fig. 1, 2, 3) and D or D+E (Fig. 4, 5, 6) together and subtract 25,6 mm (1 in.).

*Alternative end connections available upon request.

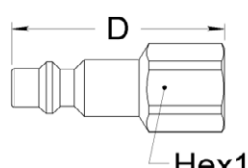
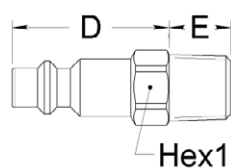

Figure 4

Figure 5

Figure 6

Plugs (Male)

Part Number	Body Size	Port Size	Thread or Hose Diam.	Type	Fig.	Dimensions							Weight		
						D	E	F	Hex1	D	E	F	Hex1	(lbs)	(g)
						(in)	(in)	(in)	(in)	(mm)	(mm)	(mm)	(mm)		
IA0090614		¼	¼	Male BSPT	4	1.34	0.51	-	0.63	34.00	13.00	-	16.00	0.07	32.00
IA0090638		¾	¾	Male BSPT	4	1.42	0.59	-	0.67	36.00	15.00	-	17.00	0.09	41.00
IA0090612		½	½	Male BSPT	4	1.57	0.67	-	0.91	40.00	17.00	-	23.00	0.12	56.00
IA0090714		¼	¼	Female BSPP	5	1.97	-	-	0.67	50.00	-	-	17.00	0.08	38.00
IA0090738		¾	¾	Female BSPP	5	1.97	-	-	0.83	50.00	-	-	21.00	0.11	49.00
IA0090712	¾	½	½	Female BSPP	5	2.09	-	-	1.02	53.00	-	-	26.00	0.15	69.00
IA0090978	-		7 mm	Hose Tail	6	1.30	1.02	0.63	-	33.00	26.00	16.00	-	0.07	30.00
IA0090989	-		8 mm	Hose Tail	6	1.30	1.02	0.63	-	33.00	26.00	16.00	-	0.07	30.00
IA0090990	-		9 mm	Hose Tail	6	1.30	1.02	0.63	-	33.00	26.00	16.00	-	0.07	31.00
IA0090901	-		10 mm	Hose Tail	6	1.30	1.02	0.63	-	33.00	26.00	16.00	-	0.07	32.00
IA0090912	-		11-12 mm	Hose Tail	6	1.30	1.22	0.63	-	33.00	31.00	16.00	-	0.08	38.00

To obtain connected length of coupling add dimensions A or A+C (Fig. 1, 2, 3) and D or D+E (Fig. 4, 5, 6) together and subtract 25,6 mm (1 in.).

*Alternative end connections available upon request.

Safeline Series

ISO 6150 C GD18500/GK18600

Pneumatic application

Danfoss' Safeline Series is an Industrial Interchange pneumatic coupling with push button safety feature designed for use with compressed air. Two-step disconnect procedure shuts off air supply and releases downstream air pressure before plug can be removed from socket/female, which prevents hose whip.



Product Features

- Safe and easy to connect and disconnect
- Light weight, compact ergonomic design
- Meets Safety Standard ISO 4414
- Meets ISO 6150 Series C Standard
- Standard body material: Dural
- Standard seal material: Buna-N
- Option: Private labelling

Physical Characteristics

Body Size	Nominal Flow Diameter (mm)	Max. Operating Pressure Connected or Disconnected		Air Flow Rate* Δp 0.6 bar/8.7 psi**				Working Temperature	
		(bar)	(psi)	(lpm)	(gpm)	(lpm)	(gpm)	°C	°F
¼	5.5	16	232	515	136	650	172	-20° +100°	-4° +212°

*Indicated values refer to an inlet pressure of 6 bar / 87 psi.

**This flow rate allows the optimum output from a pneumatic tool.

** This flow rate is the maximum recommended for a suitable output from a pneumatic tool. For applications needing higher flow rates, it is recommended to select a larger size coupling.

Applications & Markets

- General Pneumatics
- Air Tools
- Industrial Plants
- Maintenance and Repair

Flow Data

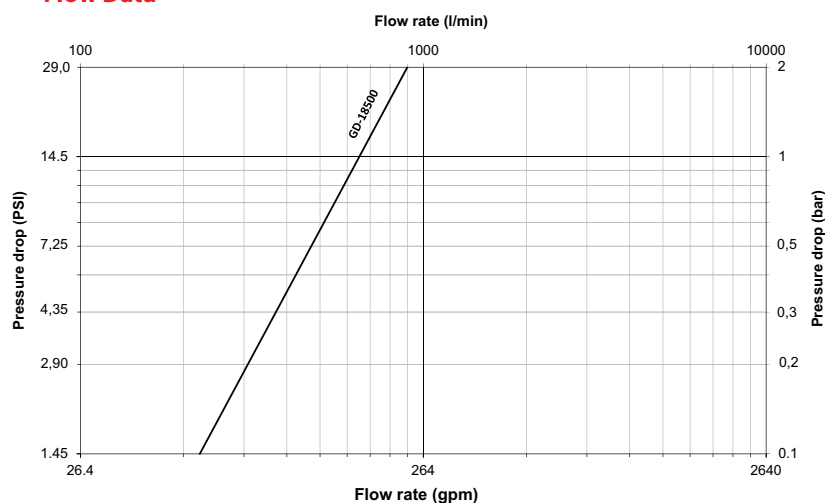

Air flow-rate at 6 bar (87 psi)

Safeline Series

ISO 6150 C GD18500/GK18600

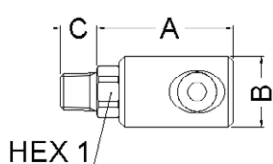

Figure 1

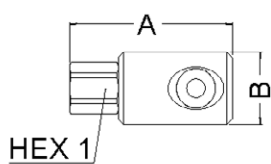

Figure 2

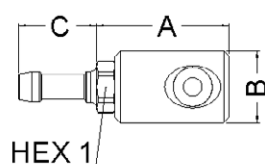

Figure 3

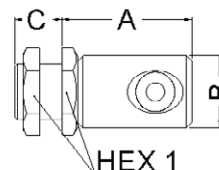

Figure 4

Sockets (Female)

Part Number	Body Size	Port Size	Thread or Hose Diam.	Type	Fig.	Dimensions			Hex1 (in)	A (mm)	B (mm)	C (mm)	Hex1 (mm)	Weight	
						A (in)	B (in)	C (in)						(lbs)	(g)
GD1853615		¼	¼	Male BSPP	1	1.85	1.02	0.47	0.75	47	26	12	19	0.17	77
GD1853614		¼	¼	Male BSPT	1	1.93	1.02	0.51	0.67	49	26	13	17	0.17	76
GD1853639		¾	¾	Male BSPP	1	1.89	1.02	0.47	0.87	48	26	12	22	0.20	91
GD1853638		¾	¾	Male BSPT	1	1.93	1.02	0.57	0.67	49	26	14.5	17	0.19	84
GD1853613		½	½	Male BSPP	1	1.97	1.02	0.55	1.06	50	26	14	27	0.25	115
GD1853612		½	½	Male BSPT	1	1.89	1.02	0.67	0.87	48	26	17	22	0.27	123
GD1852614		¼	¼	Female BSPP	2	2.30	1.02	-	0.67	58.5	26	-	17	0.17	76
GD1852638	¼	¾	¾	Female BSPP	2	2.42	1.02	-	0.87	61.5	26	-	22	0.22	99
GD1852612		½	½	Female BSPP	2	2.58	1.02	-	1.06	65.5	26	-	27	0.27	122
GD1855667		-	6 mm	Hose Tail	3	1.87	1.02	1.10	0.67	47.5	26	28	17	0.16	73
GD1855678		-	7 mm	Hose Tail	3	1.87	1.02	1.10	0.67	47.5	26	28	17	0.16	74
GD1855689		-	8 mm	Hose Tail	3	1.87	1.02	1.10	0.67	47.5	26	28	17	0.16	74
GD1855690		-	9 mm	Hose Tail	3	1.87	1.02	1.10	0.67	47.5	26	28	17	0.17	75
GD1855601		-	10 mm	Hose Tail	3	1.87	1.02	1.10	0.67	47.5	26	28	17	0.17	79
GD1855613		-	13 mm	Hose Tail	3	1.87	1.02	1.30	0.67	47.5	26	33	17	0.19	87
GD1855014		¼	¼	Female BSPP, Bulkhead*	4	1.83	1.02	0.67	1.06	46.5	26	17	27	0.25	112
GD1855038		¾	¾	Female BSPP, Bulkhead**	4	1.87	1.02	0.79	1.26	47.5	26	20	32	0.33	150

To obtain connected length of coupling add Dimensions A or A+C (Fig. 1, 2, 3, 4) and D or D+E (Fig. 5, 6, 7) together and subtract 26 mm (1,02 in).

*Max bulkhead thickness: 10 mm (0,39 in) / Bulkhead hole diameter = 21 mm (0,83 in).

**Max bulkhead thickness: 12 mm (0,47 in) / Bulkhead hole diameter = 25 mm (0,98 in)

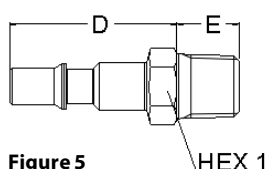

Figure 5

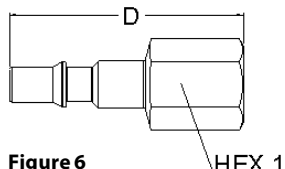

Figure 6

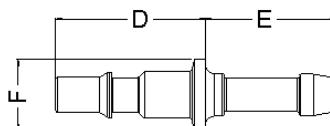

Figure 7

Plugs (Male)

Part Number	Body Size	Port Size	Thread or Hose Diam.	Type	Fig.	Dimensions			Hex1 (in)	Hex2 (in)	D (mm)	E (mm)	F (mm)	Hex1 (mm)	Hex2 (mm)	Weight	
						D (in)	E (in)	F (in)								(lbs)	(g)
GK1866319		¼	¼	Male BSPP	5	1.38	0.31	-	0.55	-	35	8	-	14	-	0.04	17
GK1866318		¼	¼	Male BSPT	5	1.34	0.31	-	0.47	-	34	8	-	12	-	0.03	14
GK1866381		¼	¼	Male NPT	5	1.34	0.39	-	0.47	-	34	10	-	12	-	0.03	15
GK1866315		¼	¼	Male BSPP	5	1.42	0.47	-	0.67	-	36	12	-	17	-	0.06	25
GK1866314		¼	¼	Male BSPT	5	1.40	0.51	-	0.55	-	35.5	13	-	14	-	0.05	23
GK1866341		¼	¼	Male NPT	5	1.42	0.59	-	0.67	-	36	15	-	17	-	0.07	30
GK1866339		¾	¾	Male BSPP	5	1.46	0.47	-	0.87	-	37	12	-	22	-	0.09	39
GK1866338		¾	¾	Male BSPT	5	1.48	0.47	-	0.75	-	37.5	12	-	19	-	0.08	37
GK1866218		¼	¼	Female BSPP	6	1.63	-	-	0.55	-	41.5	-	-	14	-	0.04	18
GK1866281	¼	¼	¼	Female NPT	6	0.00	-	-	0.00	-	-	-	-	-	-	0.04	18
GK1866214		¼	¼	Female BSPP	6	1.97	-	-	0.67	-	50	-	-	17	-	0.07	33
GK1866241		¼	¼	Female NPT	6	1.97	-	-	0.67	-	50	-	-	17	-	0.07	32
GK1866238		¾	¾	Female BSPP	6	1.85	-	-	0.83	-	47	-	-	21	-	0.08	35
GK1866245	M 14	M 14 x 125		Female Metric	6	1.87	-	-	0.67	-	47.5	-	-	17	-	0.06	26
GK1866767		-	6 mm	Hose Tail	7	1.26	1.10	0.59	-	-	32	28	15	-	-	0.03	15
GK1866778		-	7 mm	Hose Tail	7	1.26	1.10	0.59	-	-	32	28	15	-	-	0.04	18
GK1866789		-	8 mm	Hose Tail	7	1.26	1.10	0.59	-	-	32	28	15	-	-	0.04	19
GK1866790		-	9 mm	Hose Tail	7	1.26	1.10	0.59	-	-	32	28	15	-	-	0.04	19
GK1866701		-	10 mm	Hose Tail	7	1.26	1.10	0.59	-	-	32	28	15	-	-	0.04	20
GK1866713		-	13 mm	Hose Tail	7	1.26	1.30	0.79	-	-	32	33	20	-	-	0.08	34

To obtain connected length of coupling add Dimensions A or A+C (Fig. 1, 2, 3, 4) and D or D+E (Fig. 5, 6, 7) together and subtract 26 mm (1,02 in).

Safeline Series

ISO 6150 C ID18900/IK18900

Pneumatic application

Danfoss' Safeline Series is an Industrial Interchange pneumatic coupling with push button safety feature designed for use with compressed air. Two-step disconnect procedure shuts off air supply and releases downstream air pressure before plug can be removed from socket/female, which prevents hose whip.



Product Features

- Safe and easy to connect and disconnect
- Light weight, compact ergonomic design
- Meets Safety Standard ISO 4414
- Meets ISO 6150 Series C Standard
- Standard body material: Dural
- Standard seal material: Buna-N
- Option: Private labelling

Physical Characteristics

Body Size	Nominal Flow Diameter (mm)	Max. Operating Pressure Connected or Disconnected		Air Flow Rate* Δp 0.6 bar/8.7 psi**		Δp 1 bar/14.5 psi***		Working Temperature	
		(bar)	(psi)	(lpm)	(gpm)	(lpm)	(gpm)	°C	°F
3/8"	8	16	232	1,080	285	1,350	356	-20° +100°	-4° +212°

*Indicated values refer to an inlet pressure of 6 bar / 87 psi.

**This flow rate allows the optimum output from a pneumatic tool.

***This flow rate is the maximum recommended for a suitable output from a pneumatic tool. For applications needing higher flow rates, it is recommended to select a larger size coupling.

Applications & Markets

- General Pneumatics
- Air Tools
- Industrial Plants
- Maintenance and Repair

Flow Data

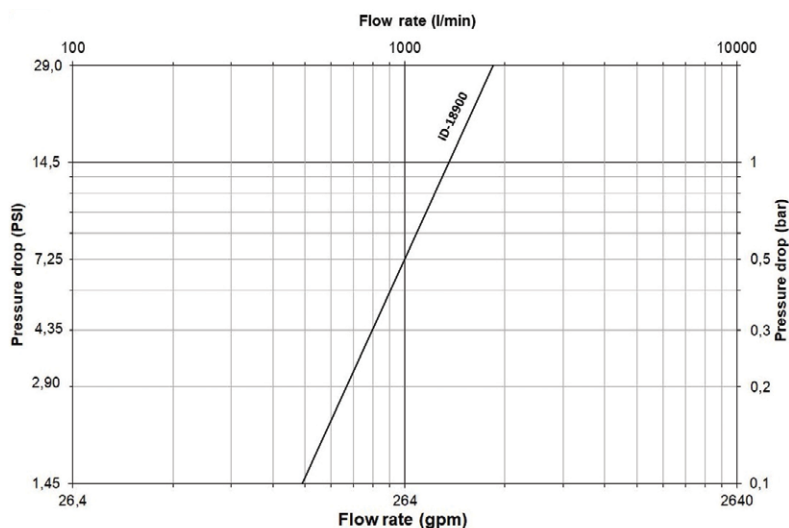

Safeline Series

ISO 6150 C ID18900/IK18900

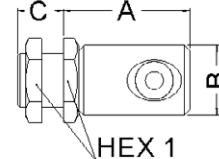
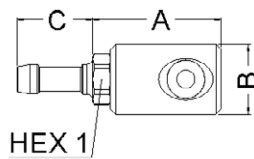
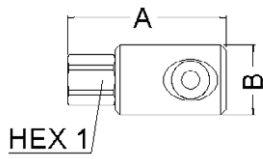
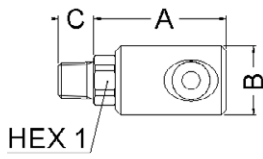

Figure 1

Figure 2

Figure 3

Figure 4

Sockets (Female)

Part Number	Body Size	Port Size	Thread or Hose Diam.	Type	Fig.	Dimensions			Hex1	A	B	C	Hex1	Weight	
						A	B	C						(mm)	(lbs)
ID1896015		¼	¼	Male BSPP	1	2.45	1.34	0.47	0.87	62	34	12	22	0.35	160
ID1896014		¼	¼	Male BSPT	1	2.45	1.34	0.51	0.87	62	34	13	22	0.36	162
ID1896039		¾	¾	Male BSPP	1	2.45	1.34	0.47	0.87	62	34	12	22	0.36	165
ID1896038		¾	¾	Male BSPT	1	2.45	1.34	0.59	0.87	62	34	15	22	0.37	168
ID1896013		½	½	Male BSPP	1	2.45	1.34	0.55	1.06	62	34	14	27	0.37	168
ID1896012		½	½	Male BSPT	1	2.45	1.34	0.67	0.87	62	34	17	22	0.40	180
ID1897014		¼	¼	Female BSPP	2	2.92	1.34	-	0.87	74	34	-	22	0.40	182
ID1897038		¾	¾	Female BSPP	2	3.02	1.34	-	0.87	77	34	-	22	0.40	180
ID1897012		½	½	Female BSPP	2	3.16	1.34	-	1.06	80	34	-	27	0.48	216
ID1895689		-	8 mm	Hose Tail	3	2.49	1.34	1.10	0.87	63	34	28	22	0.36	165
ID1895690		-	9 mm	Hose Tail	3	2.49	1.34	1.10	0.87	63	34	28	22	0.35	160
ID1895601		-	10 mm	Hose Tail	3	2.49	1.34	1.10	0.87	63	34	28	22	0.37	166
ID1895613		-	13 mm	Hose Tail	3	2.49	1.34	1.30	0.87	63	34	33	22	0.39	177
ID1895038		¾	¾	Female BSPP, Bulkhead*	4	2.37	1.34	0.79	1.26	60	34	20	32	0.52	235
ID1895012		½	¾	Female BSPP, Bulkhead**	4	2.39	1.34	0.91	1.38	61	34	23	35	0.59	269

To obtain connected length of coupling add Dimensions A or A+C (Fig. 1, 2, 3, 4) and D or D+E (Fig. 5, 6, 7) together and subtract 40 mm (1,57 in).

*Max bulkhead thickness: 12 mm (0,47 in) / Bulkhead hole diameter = 25 mm (0,98 in)

**Max bulkhead thickness: 15 mm (0,59 in) / Bulkhead hole diameter = 31 mm (1,22 in)

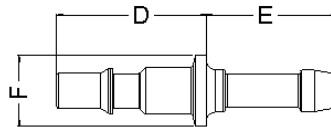
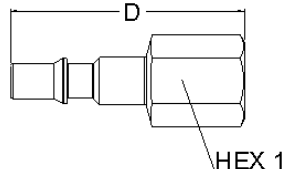
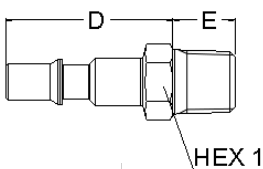

Figure 5

Figure 6

Figure 7

Plugs (Male)

Part Number	Body Size	Port Size	Thread or Hose Diam.	Type	Fig.	Dimensions			Hex1	D	E	F	Hex1	Weight	
						D	E	F						(mm)	(mm)
IK1890615		¼	¼	Male BSPP	5	1.81	0.47	-	0.75	46	12	-	19	0.10	44
IK1890614		¼	¼	Male BSPT	5	1.77	0.51	-	0.67	45	13	-	17	0.08	38
IK1890641		¼	¼	Male NPT	5	1.77	0.51	-	0.67	45	13	-	17	0.09	39
IK1890639		¾	¾	Male BSPP	5	1.81	0.47	-	0.87	46	12	-	22	0.11	51
IK1890638		¾	¾	Male BSPT	5	1.77	0.59	-	0.75	45	15	-	19	0.11	51
IK1890683		¾	¾	Male NPT	5	1.77	0.59	-	0.75	45	15	-	19	0.11	52
IK1890613		½	½	Male BSPP	5	1.81	0.55	-	1.02	46	14	-	26	0.16	73
IK1890612		¾	½	Male BSPT	5	1.77	0.67	-	0.87	45	17	-	22	0.15	66
IK1890714		¼	¼	Female BSPP	6	2.36	-	-	0.67	60	-	-	17	0.09	40
IK1890741		¼	¼	Female NPT	6	2.36	-	-	0.67	60	-	-	17	0.09	40
IK1890738		¾	¾	Female BSPP	6	2.36	-	-	0.83	60	-	-	21	0.11	52
IK1890783		¾	¾	Female NPT	6	2.36	-	-	0.83	60	-	-	21	0.12	55
IK1890712		½	½	Female BSPP	6	2.36	-	-	1.02	60	-	-	26	0.15	66
IK1890989		-	8 mm	Hose Tail	7	1.65	1.10	0.63	-	42	28	16	-	0.07	33
IK1890990		-	9 mm	Hose Tail	7	1.65	1.10	0.63	-	42	28	16	-	0.07	33
IK1890901		-	10 mm	Hose Tail	7	1.65	1.10	0.63	-	42	28	16	-	0.08	35
IK1890913		-	13 mm	Hose Tail	7	1.65	1.30	0.79	-	42	33	20	-	0.10	46

To obtain connected length of coupling add Dimensions A or A+C (Fig. 1, 2, 3, 4) and D or D+E (Fig. 5, 6, 7) together and subtract 40 mm (1,57 in).

Safeline Series

ISO 6150 C TD18300/TK18300

Pneumatic application



Danfoss' Safeline Series is an Industrial Interchange pneumatic coupling with push button safety feature designed for use with compressed air. Two-step disconnect procedure shuts off air supply and releases downstream air pressure before plug can be removed from socket/female, which prevents hose whip.

Product Features

- Safe and easy to connect and disconnect
- Light weight, compact ergonomic design
- Meets Safety Standard ISO 4414
- Meets ISO 6150 Series C Standard
- Standard body material: Dural
- Standard seal material: Buna-N
- Option: Private labelling

Physical Characteristics

Body Size	Nominal Flow Diameter (mm)	Max. Operating Pressure Connected or Disconnected		Air Flow Rate* Δp 0.6 bar/8.7 psi**		Δp 1 bar/14.5 psi***		Working Temperature	
		(bar)	(psi)	(lpm)	(gpm)	(lpm)	(gpm)	°C	°F
½	11	16	232	2,400	634	3,000	793	-20° +100°	-4° +212°

*Indicated values refer to an inlet pressure of 6 bar / 87 psi.

**This flow rate allows the optimum output from a pneumatic tool.

*** This flow rate is the maximum recommended for a suitable output from a pneumatic tool. For applications needing higher flow rates, it is recommended to select a larger size coupling.

Applications & Markets

- General Pneumatics
- Air Tools
- Industrial Plants
- Maintenance and Repair

Flow Data

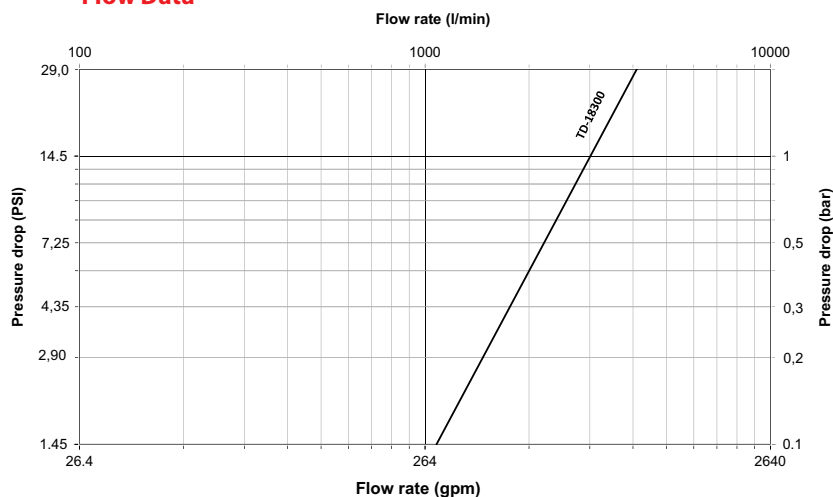

Air flow-rate at 6 bar (87 psi)

Safeline Series

ISO 6150 C TD18300/TK18300

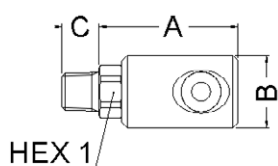

Figure 1

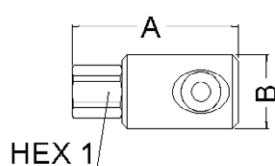

Figure 2

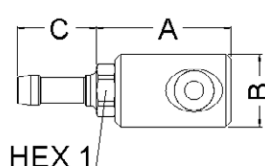

Figure 3

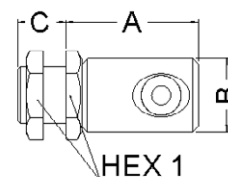

Figure 4

Sockets (Female)

Part Number	Body Size	Port Size	Thread or Hose Diam. Type	Fig.	Dimensions					Weight								
					A	B	C	Hex1	Hex2	A	B	C	Hex1	Hex2	(lbs)	(g)		
					(in)	(in)	(in)	(in)	(in)	(in)	(mm)	(mm)	(mm)	(mm)	(mm)	(mm)	(mm)	(mm)
TD1832012		½	½	Male BSPT	1	2.78	1.56	0.67	1.06	–	70.6	39.5	17	27	–	0.58	262	
TD1832034		¾	¾	Male BSPT	1	2.78	1.56	0.73	1.14	–	70.6	39.5	19	29	–	0.63	287	
TD1832138		¾	¾	Female BSPP	2	3.27	1.56	–	1.06	–	83.1	39.5	–	27	–	0.62	280	
TD1832112		½	½	Female BSPP	2	3.27	1.56	–	1.06	–	83.1	39.5	–	27	–	0.58	261	
TD1832134	½	¾	¾	Female BSPP	2	3.51	1.56	–	1.26	–	89.1	39.5	–	32	–	0.67	304	
TD1835601	–	–	10 mm	Hose Tail	3	2.84	1.56	1.10	1.06	–	72.1	39.5	28	27	–	0.56	256	
TD1835613	–	–	13 mm	Hose Tail	3	2.84	1.56	1.30	1.06	–	72.1	39.5	33	27	–	0.59	267	
TD1835616	–	–	16 mm	Hose Tail	3	2.84	1.56	1.30	1.06	–	72.1	39.5	33	27	–	0.60	270	
TD1835012	½	½	Female BSPP, Bulkhead*	4	2.78	1.56	0.91	1.38	–	70.6	39.5	23	35	–	0.76	343		
TD1835034	¾	¾	Female BSPP, Bulkhead**	4	2.82	1.56	0.98	1.50	–	71.6	39.5	25	38	–	0.77	350		

To obtain connected length of coupling add Dimensions A or A+C (Fig. 1, 2, 3, 4) and D or D+E (Fig. 5, 6, 7) together and subtract 20 mm (0,79 in).

*Max bulkhead thickness: 15 mm (0,59 in) / Bulkhead hole diameter = 31 mm (1,22 in)

**Max bulkhead thickness: 16 mm (0,63 in) / Bulkhead hole diameter = 33 mm (1,30 in)

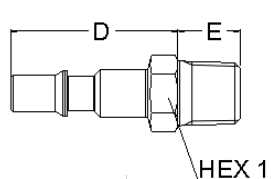

Figure 5

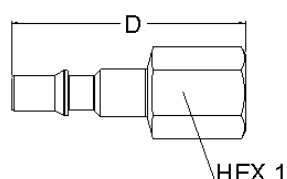

Figure 6

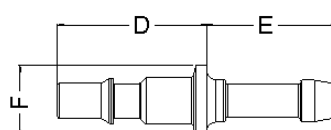

Figure 7

Plugs (Male)

Part Number	Body Size	Port Size	Thread or Hose Diam. Type	Fig.	Dimensions					Weight						
					D	E	F	Hex1	D	E	F	Hex1	(lbs)	(g)		
					(in)	(in)	(in)	(in)	(in)	(mm)	(mm)	(mm)	(mm)	(mm)	(mm)	(mm)
TK1831539		¾	¾	Male BSPP	5	2.01	0.47	–	0.87	51.1	11.9	–	22	–	2.32	59
TK1831512		½	½	Male BSPT	5	1.97	0.67	–	0.87	50	17	–	22	–	2.56	65
TK1831534		¾	¾	Male BSPT	5	2.11	0.73	–	1.14	53.5	18.5	–	29	–	3.86	98
TK1831638		¾	¾	Female BSPP	6	2.56	–	–	1.02	65	–	–	26	–	3.70	94
TK1831612	½	½	½	Female BSPP	6	2.56	–	–	1.02	65	–	–	26	–	3.02	77
TK1831634		¾	¾	Female BSPP	6	2.87	–	–	1.26	73	–	–	32	–	5.02	128
TK1831889	–	–	8 mm	Hose Tail	7	1.85	1.10	0.79	–	47	28	20	–	–	1.87	48
TK1831801	–	–	10 mm	Hose Tail	7	1.85	1.10	0.79	–	47	28	20	–	–	1.91	48
TK1831813	–	–	13 mm	Hose Tail	7	1.85	1.30	0.79	–	47	33	20	–	–	2.19	56
TK1831816	–	–	16 mm	Hose Tail	7	1.85	1.30	0.79	–	47	33	20	–	–	2.40	61

To obtain connected length of coupling add Dimensions A or A+C (Fig. 1, 2, 3, 4) and D or D+E (Fig. 5, 6, 7) together and subtract 20 mm (0,79 in).

1000/400/500 Series

Pneumatic application



Danfoss Hansen 1000/400/500 Series is an Industrial Interchange pneumatic coupling that is rugged and reliable designed for use with compressed air, gases, and liquids.

Product Features

- Ball latching mechanism
- Optional sleeve lock prevents accidental disconnection
- All sizes accept US Industrial Interchange
- 1/4" & 1/2" accept ISO 6150 B and A-A-59439 plugs/males
- 400 series accepts Tru-Flate
- Standard body material: brass, steel and stainless steel with nickel plated steel sleeve
- Standard seal material: Buna-N
- Optional seal materials: Silicone-138, FKM-143, EPDM-192

Physical Characteristics

Series	Body Size	Max. Operating Pressure		Min. Burst Pressure		Rated Flow	
	(in)	(bar)	(psi)	(bar)	(psi)	(lpm)	(gpm)
1000	1/4	138	2,000	552	8,000	9	179
400	3/8	69	1,000	276	4,000	1,274	336
500	1/2	35	500	140	2,000	2,038	538

Applications & Markets

- General Pneumatics
- Construction
- Industrial Plants

Interchangeability

All Sizes	1/4" & 1/2"	400 Series
US Industrial Interchange	ISO 6150 Series B A-A-59439 (former MIL-C-4109)	Tru-Flate

Flow Data

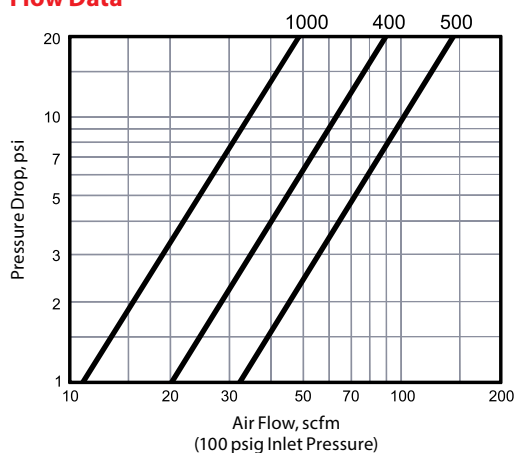

1000 Series

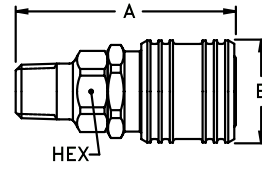

Figure 1

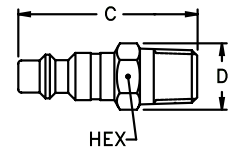

Figure 2

Male NPTF Connections

Part Number	Coupling Type	Body Size	Port Size	Thread	Type	Material	Fig.	Dimensions			Hex	A	B	Hex	
								A	B	Hex					
								(in)	(in)	(in)	(mm)	(mm)	(mm)		
900	Socket/Female	1/4	1/8	1/8-27	NPTF	Brass	1	1.97	1.00	0.69	50.04	25.40	17.53		
1100	Socket/Female	1/4	1/4	1/4-18	NPTF	Brass	1	2.16	1.00	0.69	54.86	25.40	17.53		
1300	Socket/Female	1/4	3/8	3/8-18	NPTF	Brass	1	2.12	1.00	0.69	53.85	25.40	17.53		
LL1100	Socket/Female	1/4	1/4	1/4-18	NPTF	Stainless	1	2.16	1.00	0.69	54.86	25.40	17.53		
Part Number	Coupling Type	Body Size	Port Size	Thread	Type	Material	Fig.	Dimensions			Hex	C	D	Hex	
								C	D	Hex					
								(in)	(in)	(in)	(mm)	(mm)	(mm)		
10	Plug/Male	1/4	1/4	1/4-18	NPTF	Steel	2	1.75	0.62	0.56	44.45	15.75	14.22		
10C§	Plug/Male	1/4	1/4	1/4-18	NPTF	Steel	2	1.75	0.65	0.56	44.45	16.51	14.22		
10G†	Plug/Male	1/4	1/4	1/4-18	NPTF	Steel	2	1.75	0.65	0.56	44.45	16.51	14.22		
12E	Plug/Male	1/4	1/8	1/8-27	NPTF	Steel	2	1.59	0.58	0.50	40.38	14.73	12.7		
12G†	Plug/Male	1/4	1/8	1/8-27	NPTF	Steel	2	2.38	0.77	0.69	60.45	19.55	17.52		
12100412	Plug/Male	1/4	3/8	3/8-18	NPTF	Steel	2	1.75	0.79	0.69	44.45	20.06	17.52		
14G†	Plug/Male	1/4	3/8	3/8-18	NPTF	Steel	2	2.53	0.77	0.69	64.26	19.55	17.52		
B10	Plug/Male	1/4	1/4	1/4-18	NPTF	Brass	2	1.75	0.62	0.56	44.45	16.25	14.22		
LL10	Plug/Male	1/4	1/4	1/4-18	NPTF	Stainless	2	1.75	0.62	0.56	44.45	16.51	14.22		
10NK*	Plug/Male	1/4	1/4	1/4-18	NPTF	Steel	2	1.75	0.62	0.56	44.45	15.75	14.22		

§With Ball Check †With Bleeder Ball Check—Reduces Hose Whip *Nickel plated

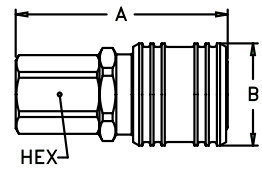

Figure 3

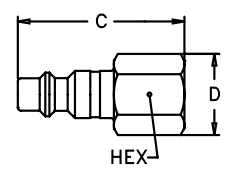

Figure 4

Female NPTF Connections

Part Number	Coupling Type	Body Size	Port Size	Thread	Type	Material	Fig.	Dimensions			Hex	A	B	Hex	
								A	B	Hex					
								(in)	(in)	(in)	(mm)	(mm)	(mm)		
800E	Socket/Female	1/4	1/8	1/8-27	NPTF	Brass	3	1.86	1.00	0.69	47.24	25.40	17.53		
1000E	Socket/Female	1/4	1/4	1/4-18	NPTF	Brass	3	2.08	1.00	0.69	52.83	25.40	17.53		
1200	Socket/Female	1/4	3/8	3/8-18	NPTF	Brass	3	2.16	1.00	0.75	54.86	25.40	19.05		
LL1000	Socket/Female	1/4	1/4	1/4-18	NPTF	Stainless	3	2.08	1.00	0.69	52.83	25.40	17.53		
Part Number	Coupling Type	Body Size	Port Size	Thread	Type	Material	Fig.	Dimensions			Hex	C	D	Hex	
								C	D	Hex					
								(in)	(in)	(in)	(mm)	(mm)	(mm)		
11	Plug/Male	1/4	1/4	1/4-18	NPTF	Steel	4	1.63	0.79	0.69	41.40	20.07	17.53		
11G†	Plug/Male	1/4	1/4	1/4-18	NPTF	Steel	4	2.44	0.77	0.69	61.98	19.56	17.53		
13	Plug/Male	1/4	1/8	1/8-27	NPTF	Steel	4	1.47	0.65	0.56	37.34	16.51	14.22		
15E	Plug/Male	1/4	3/8	3/8-18	NPTF	Steel	4	1.69	0.94	0.81	42.93	23.88	20.57		
11B	Plug/Male	1/4	1/4	1/4-18	NPTF	Brass	4	1.63	0.78	0.69	41.40	19.81	17.53		
LL11	Plug/Male	1/4	1/4	1/4-18	NPTF	Stainless	4	1.63	0.79	0.69	41.40	20.07	17.53		
11NK*	Plug/Male	1/4	1/4	1/4-18	NPTF	Steel	4	1.63	0.79	0.69	41.40	20.07	17.53		

†With Bleeder Ball Check—Reduces Hose Whip *Nickel plated

1000 Series

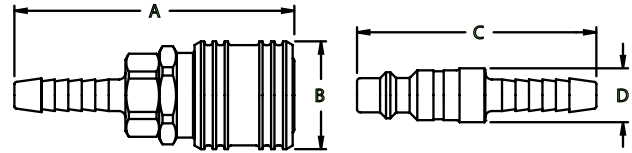

Figure 5

Figure 6

Hose Stem End Connections

Part Number	Coupling Type	Body Size	Hose I.D.	Material	Fig.	Dimensions			
						A	B	A	B
						(in)	(in)	(mm)	(mm)
1600E	Socket/Female	1/4	1/4	Brass	5	2.60	1.00	66.04	25.40
1600P‡	Socket/Female	1/4	1/4	Brass	5,5A	2.37	1.00	60.20	25.40
1700E	Socket/Female	1/4	3/8	Brass	5	2.60	1.00	66.04	25.40
1700P‡	Socket/Female	1/4	3/8	Brass	5,5A	2.44	1.00	61.98	25.40
1800	Socket/Female	1/4	5/16	Brass	5	2.60	1.00	66.04	25.40
Part Number	Coupling Type	Body Size	Hose I.D.	Material	Fig.	Dimensions			
						C	D	C	D
						(in)	(in)	(mm)	(mm)
12103875	Plug/Male	1/4	1/4	Steel	6	2.22	0.50	56.39	12.70
16G†	Plug/Male	1/4	1/4	Steel	6	2.97	0.77	75.44	19.56
16P‡	Plug/Male	1/4	1/4	Steel	6,6A	2.00	0.58	50.80	14.73
17	Plug/Male	1/4	3/8	Steel	6	2.22	0.5	56.39	12.70
17G‡	Plug/Male	1/4	3/8	Steel	6	2.96	0.77	75.18	19.56
17P‡	Plug/Male	1/4	3/8	Steel	6,6A	2.06	0.5	52.32	12.70
18E	Plug/Male	1/4	5/16	Steel	6	2.22	0.50	56.39	12.70
B17	Plug/Male	1/4	3/8	Brass	6	2.22	0.5	56.39	12.70
16NK*	Plug/Male	1/4	1/4	Steel	6	2.22	0.50	56.39	12.70
17NK*	Plug/Male	1/4	3/8	Steel	6	2.22	0.5	56.39	12.70

†With Bleeder Ball Check—Reduces Hose Whip ‡For use with push-on style hose *Nickel plated

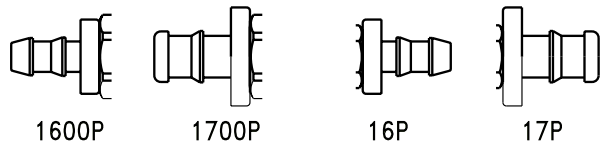

Figure 5A

Figure 6A

1000 Series

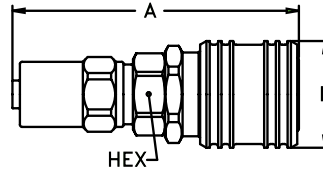

Figure 7

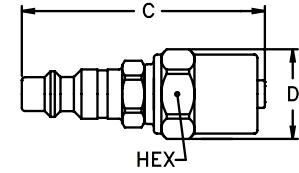

Figure 8

Hose Clamp End Connections

Part Number	Coupling Type	Body Size	Hose I.D.	Hose O.D.	Material	Fig.	Dimensions		Hex	A	B	Hex
							A	B				
							(in)	(in)	(in)	(mm)	(mm)	(mm)
1SB1	Socket/Female	1/4	1/4	15/32	Brass	7	2.69	1.00	0.69	68.33	25.40	17.53
1SB3	Socket/Female	1/4	1/4	1/2	Brass	7	2.69	1.00	0.69	68.33	25.40	17.53
1SB5E	Socket/Female	1/4	1/4	9/16	Brass	7	2.69	1.00	0.69	68.33	25.40	17.53
1SB7	Socket/Female	1/4	1/4	5/8	Brass	7	2.69	1.00	0.69	68.33	25.40	17.53
1SC5	Socket/Female	1/4	5/16	9/16	Brass	7	2.75	1.00	0.69	69.85	25.40	17.53
1SC7	Socket/Female	1/4	5/16	5/8	Brass	7	2.75	1.00	0.69	69.85	25.40	17.53
1SC9	Socket/Female	1/4	5/16	11/16	Brass	7	2.75	1.00	0.69	69.85	25.40	17.53
1SD5	Socket/Female	1/4	3/8	9/16	Brass	7	2.81	1.00	0.69	71.37	25.40	17.53
1SD7	Socket/Female	1/4	3/8	5/8	Brass	7	2.81	1.00	0.69	71.37	25.40	17.53
1SD9	Socket/Female	1/4	3/8	11/16	Brass	7	2.81	1.00	0.69	71.37	25.40	17.53
1SD11	Socket/Female	1/4	3/8	3/4	Brass	7	2.81	1.00	0.69	71.37	25.40	17.53
Part Number	Coupling Type	Body Size	Hose I.D.	Hose O.D.	Material	Fig.	Dimensions		Hex	C	D	Hex
							C	D				
							(in)	(in)	(in)	(mm)	(mm)	(mm)
3PB1	Plug/Male	1/4	1/4	15/32	Steel	8	2.31	0.70	0.63	58.67	17.78	16.00
3PB3	Plug/Male	1/4	1/4	1/2	Steel	8	2.31	0.70	0.63	58.67	17.78	16.00
3PB5	Plug/Male	1/4	1/4	9/16	Steel	8	2.31	0.77	0.69	58.67	19.56	17.53
3PB7	Plug/Male	1/4	1/4	5/8	Steel	8	2.31	0.84	0.75	58.67	21.34	19.05
3PB9	Plug/Male	1/4	1/4	11/16	Steel	8	2.31	0.94	0.81	58.67	23.88	20.57
3PB11	Plug/Male	1/4	1/4	3/4	Steel	8	2.31	0.98	0.88	58.67	24.89	22.35
3PC5	Plug/Male	1/4	5/16	9/16	Steel	8	2.38	0.77	0.69	60.45	19.56	17.53
3PC7	Plug/Male	1/4	5/16	5/8	Steel	8	2.38	0.84	0.75	60.45	21.34	19.05
3PC9	Plug/Male	1/4	5/16	11/16	Steel	8	2.38	0.91	0.81	60.45	23.11	20.57
3PD5	Plug/Male	1/4	3/8	9/16	Steel	8	2.44	0.77	0.69	61.98	19.56	17.53
3PD7	Plug/Male	1/4	3/8	5/8	Steel	8	2.44	0.84	0.75	61.98	21.34	19.05
3PD9	Plug/Male	1/4	3/8	11/16	Steel	8	2.44	0.91	0.81	61.98	23.11	20.57
3PD11	Plug/Male	1/4	3/8	3/4	Steel	8	2.44	1.01	0.88	61.98	25.65	22.35

400 Series

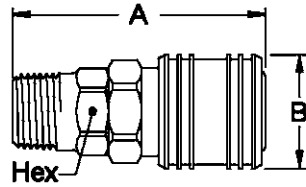

Figure 1

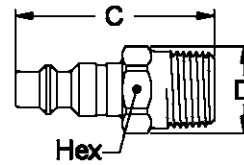

Figure 2

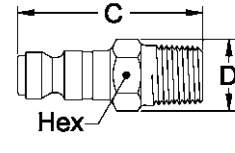

Figure 2A

Male NPTF Connections

Part Number	Coupling Type	Body Size	Port Size	Thread	Type	Material	Fig.	Dimensions			A	B	Hex
								A	B	Hex			
								(in)	(in)	(in)	(mm)	(mm)	(mm)
410	Socket/Female	3/8	1/4	1/4-18	NPTF	Brass	1	2.35	1.13	0.88	59.69	28.70	22.35
430	Socket/Female	3/8	3/8	3/8-18	NPTF	Brass	1	2.35	1.13	0.88	59.69	28.70	22.35
450	Socket/Female	3/8	1/2	1/2-14	NPTF	Brass	1	2.54	1.13	0.88	64.52	28.70	22.35
Part Number	Coupling Type	Body Size	Port Size	Thread	Type	Material	Fig.	Dimensions			C	D	Hex
								C	D	Hex			
								(in)	(in)	(in)	(mm)	(mm)	(mm)
38	Plug/Male	3/8	1/8	1/8-27	NPTF	Steel	2	1.72	0.72	0.63	43.69	18.29	16.00
40	Plug/Male	3/8	1/4	1/4-18	NPTF	Steel	2	1.88	0.72	0.63	47.75	18.29	16.00
40NK*	Plug/Male	3/8	1/4	1/4-18	NPTF	Steel	2	1.88	0.72	0.63	47.75	18.29	16.00
40G†	Plug/Male	3/8	1/4	1/4-18	NPTF	Steel	2	2.65	0.77	0.69	67.31	19.56	17.53
42	Plug/Male	3/8	3/8	3/8-18	NPTF	Steel	2	1.88	0.79	0.69	47.75	20.07	17.53
42G†	Plug/Male	3/8	3/8	3/8-18	NPTF	Steel	2	2.65	0.77	0.69	67.31	19.56	17.53
44	Plug/Male	3/8	1/2	1/2-14	NPTF	Steel	2	2.09	1.01	0.88	53.09	25.65	22.35
B40	Plug/Male	3/8	1/4	1/4-18	NPTF	Brass	2	1.88	0.70	0.63	47.75	17.78	16.00
B42	Plug/Male	3/8	3/8	3/8-18	NPTF	Brass	2	1.88	0.77	0.69	47.75	19.56	17.53
31AP25M	Plug/Male	3/8	1/4	1/4-18	NPTF	Steel	2A	1.85	0.72	0.63	46.99	18.29	16.00
31AP37M	Plug/Male	3/8	3/8	3/8-18	NPTF	Steel	2A	1.85	0.79	0.69	46.99	20.07	17.53

†With Bleeder Ball Check—Reduces Hose Whip *Nickel plated

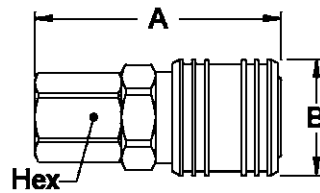

Figure 3

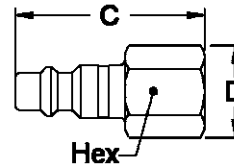

Figure 4

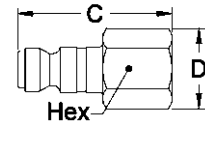

Figure 4A

Female NPTF Connections

Part Number	Coupling Type	Body Size	Port Size	Thread	Type	Material	Fig.	Dimensions			A	B	Hex
								A	B	Hex			
								(in)	(in)	(in)	(mm)	(mm)	(mm)
400	Socket/Female	3/8	1/4	1/4-18	NPTF	Brass	3	2.10	1.13	0.88	53.34	28.70	22.35
420	Socket/Female	3/8	3/8	3/8-18	NPTF	Brass	3	2.35	1.13	0.88	59.69	28.70	22.35
440	Socket/Female	3/8	1/2	1/2-14	NPTF	Brass	3	2.62	1.13	1.00	66.55	28.70	25.40
Part Number	Coupling Type	Body Size	Port Size	Thread	Type	Material	Fig.	Dimensions			C	D	Hex
								C	D	Hex			
								(in)	(in)	(in)	(mm)	(mm)	(mm)
41	Plug/Male	3/8	1/4	1/4-18	NPTF	Steel	4	1.63	0.79	0.69	41.40	20.07	17.53
41NK*	Plug/Male	3/8	1/4	1/4-18	NPTF	Steel	4	1.63	0.79	0.69	41.40	20.07	17.53
41G†	Plug/Male	3/8	1/4	1/4-18	NPTF	Steel	4	2.56	0.77	0.69	65.02	19.56	17.53
43	Plug/Male	3/8	3/8	3/8-18	NPTF	Steel	4	1.81	0.94	0.81	45.97	23.88	20.57
43G†	Plug/Male	3/8	3/8	3/8-18	NPTF	Steel	4	2.62	0.84	0.75	66.55	21.34	19.05
45E	Plug/Male	3/8	1/2	1/2-14	NPTF	Steel	4	2.06	1.15	1.00	52.32	29.21	25.40
B43	Plug/Male	3/8	3/8	3/8-18	NPTF	Brass	4	1.81	0.91	0.81	45.97	23.11	20.57
31AP25F	Plug/Male	3/8	1/4	1/4-18	NPTF	Steel	4A	1.60	0.79	0.69	40.64	20.07	17.53
31AP37F	Plug/Male	3/8	3/8	3/8-18	NPTF	Steel	4A	1.78	0.94	0.81	45.21	23.88	20.57

†With Bleeder Ball Check—Reduces Hose Whip *Nickel plated

400 Series

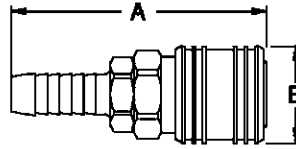

Figure 5

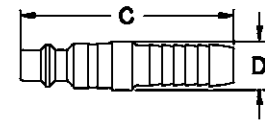

Figure 6

Hose Stem End Connections

Part Number	Coupling Type	Body Size	Hose I.D.	Material	Fig.	Dimensions			
						B	A	B	D
						(in)	(in)	(mm)	(mm)
4004E	Socket/Female	3/8	1/4	Brass	5	2.82	1.13	71.63	28.70
4050E	Socket/Female	3/8	5/16	Brass	5	2.82	1.13	71.63	28.70
4006E	Socket/Female	3/8	3/8	Brass	5	2.82	1.13	71.63	28.70
4008E	Socket/Female	3/8	1/2	Brass	5	2.82	1.13	71.63	28.70
Part Number	Coupling Type	Body Size	Hose I.D.	Material	Fig.	Dimensions			
						C	D	C	D
						(in)	(in)	(mm)	(mm)
404	Plug/Male	3/8	1/4	Steel	6	2.34	0.72	59.44	18.29
406	Plug/Male	3/8	3/8	Steel	6	2.34	0.63	59.44	16.00
408	Plug/Male	3/8	1/2	Steel	6	2.34	0.81	59.44	20.57
B406E	Plug/Male	3/8	3/8	Brass	6	2.34	0.63	59.44	16.00

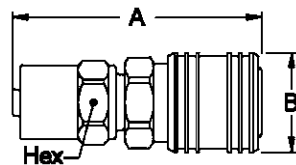

Figure 7

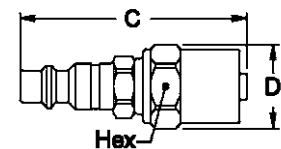

Figure 8

Hose Clamp End Connections

Part Number	Coupling Type	Body Size	Hose I.D.	Hose O.D.	Material	Fig.	Dimensions					
							A	B	Hex	A	B	Hex
							(in)	(in)	(in)	(mm)	(mm)	(mm)
40SD7	Socket/Female	3/8	3/8	5/8	Brass	7	3.04	1.13	0.75	77.22	28.70	19.05
40SD9	Socket/Female	3/8	3/8	11/16	Brass	7	3.04	1.13	0.81	77.22	28.70	20.57
40SD11	Socket/Female	3/8	3/8	3/4	Brass	7	3.04	1.13	0.88	77.22	28.70	22.35
40SP13	Socket/Female	3/8	1/2	13/16	Brass	7	3.67	1.13	0.94	93.22	28.70	23.88
40SP15	Socket/Female	3/8	1/2	7/8	Brass	7	3.67	1.13	1.00	93.22	28.70	25.40
40SP17	Socket/Female	3/8	1/2	5/16	Brass	7	3.67	1.13	1.00	93.22	28.70	25.40
40SP19	Socket/Female	3/8	1/2	1	Brass	7	3.67	1.13	1.13	93.22	28.70	28.70
Part Number	Coupling Type	Body Size	Hose I.D.	Hose O.D.	Material	Fig.	Dimensions					
							C	D	Hex	C	D	Hex
							(in)	(in)	(in)	(mm)	(mm)	(mm)
4PB3	Plug/Male	3/8	1/4	1/2	Steel	8	2.44	0.70	0.63	61.98	17.78	16.00
4PB5	Plug/Male	3/8	1/4	9/16	Steel	8	2.44	0.77	0.69	61.98	19.56	17.53
4PB7	Plug/Male	3/8	1/4	5/8	Steel	8	2.44	0.84	0.75	61.98	21.34	19.05
4PD7	Plug/Male	3/8	3/8	5/8	Steel	8	2.56	0.84	0.75	65.02	21.34	19.05
4PD9	Plug/Male	3/8	3/8	11/16	Steel	8	2.56	0.91	0.81	65.02	23.11	20.57
4PD11	Plug/Male	3/8	3/8	3/4	Steel	8	2.56	0.98	0.88	65.02	24.89	22.35
4PD15	Plug/Male	3/8	3/8	7/8	Steel	8	2.56	1.12	1.00	65.02	28.45	25.40
4PP13	Plug/Male	3/8	1/2	13/16	Steel	8	3.25	1.05	0.94	82.55	26.67	23.88
4PP15	Plug/Male	3/8	1/2	7/8	Steel	8	3.25	1.12	1.00	82.55	28.45	25.40
4PP19	Plug/Male	3/8	1/2	1	Steel	8	3.25	1.26	1.13	82.55	32.00	28.58

Dust Plugs

Series	Dust Plug Number
1000	XPSDC1HK
400	XPSDC2HK



Vinyl Dust Plug

500 Series

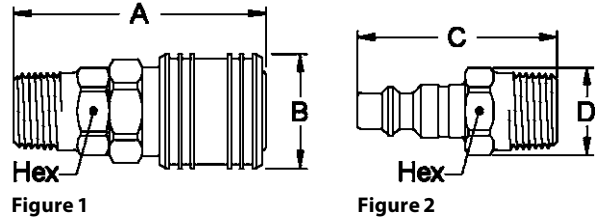

Male End Connections

Part Number	Coupling Type	Body Size	Port Size	Thread	Type	Material	Fig.	Dimensions			Hex	A	B	Hex
								A	B	Hex				
								(in)	(in)	(in)	(mm)	(mm)	(mm)	
501	Socket/Female	1/2	1/4	1/4-18	NPTF	Brass	1	2.77	1.19	1.00	70.36	30.23	25.40	
510	Socket/Female	1/2	3/8	3/8-18	NPTF	Brass	1	2.78	1.19	1.00	70.61	30.23	25.40	
530E	Socket/Female	1/2	1/2	1/2-14	NPTF	Brass	1	2.97	1.19	1.00	75.44	30.23	25.40	
550	Socket/Female	1/2	3/4	3/4-14	NPTF	Brass	1	2.97	1.19	1.06	75.44	30.23	26.92	
530143	Socket/Female	1/2	1/2	1/2-14	NPTF	Brass	1	2.97	1.19	1.00	75.44	30.23	25.40	
550NV	Socket/Female	1/2	3/4	3/4-14	NPTF	Brass	1	2.97	1.19	1.06	75.44	30.23	26.92	
Part Number	Coupling Type	Body Size	Port Size	Thread	Type	Material	Fig.	Dimensions			Hex	C	D	Hex
								C	D	Hex				
								(in)	(in)	(in)	(mm)	(mm)	(mm)	
50E	Plug/Male	1/2	1/4	1/4-18	NPTF	Steel	2	2.25	0.79	0.69	57.15	20.07	17.53	
50G†	Plug/Male	1/2	1/4	1/4-18	NPTF	Steel	2	2.90	0.98	0.88	73.66	24.89	22.35	
52	Plug/Male	1/2	3/8	3/8-18	NPTF	Steel	2	2.25	0.87	0.75	57.15	22.10	19.05	
52G†	Plug/Male	1/2	3/8	3/8-18	NPTF	Steel	2	2.90	0.98	0.88	73.66	24.89	22.35	
54E	Plug/Male	1/2	1/2	1/2-14	NPTF	Steel	2	2.44	1.01	0.88	61.98	25.65	22.35	
54G†	Plug/Male	1/2	1/2	1/2-14	NPTF	Steel	2	3.09	0.98	0.88	78.49	24.89	22.35	
56	Plug/Male	1/2	3/4	3/4-14	NPTF	Steel	2	2.50	1.23	1.06	63.50	31.24	26.92	
56G†	Plug/Male	1/2	3/4	3/4-14	NPTF	Steel	2	3.14	1.19	1.06	79.76	30.23	26.92	
B52	Plug/Male	1/2	3/8	3/8-18	NPTF	Brass	2	2.25	0.87	0.75	57.15	22.10	19.05	
B54	Plug/Male	1/2	1/2	1/2-14	NPTF	Brass	2	2.44	1.01	0.88	61.98	25.65	22.35	

†With Bleeder Ball Check—Reduces Hose Whip

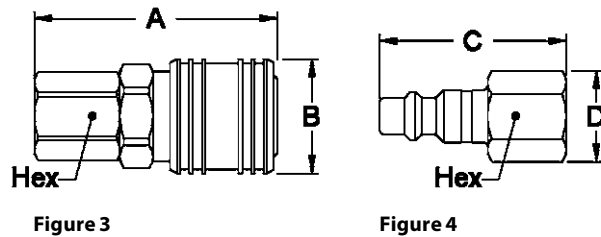

Female End Connections

Part Number	Coupling Type	Body Size	Port Size	Thread	Type	Material	Fig.	Dimensions			Hex	A	B	Hex
								A	B	Hex				
								(in)	(in)	(in)	(mm)	(mm)	(mm)	
500A	Socket/Female	1/2	1/4	1/4-18	NPTF	Brass	3	2.72	1.19	1.00	69.1	30.2	25.4	
500	Socket/Female	1/2	3/8	3/8-18	NPTF	Brass	3	2.78	1.19	1.00	70.6	30.2	25.4	
520	Socket/Female	1/2	1/2	1/2-14	NPTF	Brass	3	3.06	1.19	1.00	77.7	30.2	25.4	
540	Socket/Female	1/2	3/4	3/4-14	NPTF	Brass	3	3.09	1.19	1.19	78.5	30.2	30.2	
Part Number	Coupling Type	Body Size	Port Size	Thread	Type	Material	Fig.	Dimensions			Hex	C	D	Hex
								C	D	Hex				
								(in)	(in)	(in)	(mm)	(mm)	(mm)	
53A	Plug/Male	1/2	1/4	1/4-18	NPTF	Steel	4	1.92	0.79	0.69	48.8	20.1	17.5	
53	Plug/Male	1/2	3/8	3/8-18	NPTF	Steel	4	2.06	0.94	0.81	52.3	23.9	20.6	
53G†	Plug/Male	1/2	3/8	3/8-18	NPTF	Steel	4	2.90	0.98	0.88	73.7	24.9	22.4	
55	Plug/Male	1/2	1/2	1/2-14	NPTF	Steel	4	2.34	1.15	1.00	59.4	29.2	25.4	
55G†	Plug/Male	1/2	1/2	1/2-14	NPTF	Steel	4	3.17	1.15	1.00	80.5	29.2	25.4	
57	Plug/Male	1/2	3/4	3/4-14	NPTF	Steel	4	2.44	1.37	1.19	62.0	34.8	30.2	

†With Bleeder Ball Check—Reduces Hose Whip

500 Series

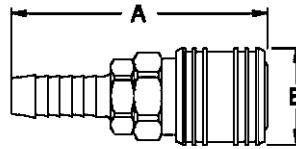

Figure 5

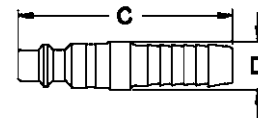

Figure 6

Hose Stem End Connections

Part Number	Coupling Type	Body Size	Hose I.D.	Material	Fig.	Dimensions			
						A (in)	B (in)	A (mm)	B (mm)
570	Socket/Female	1/2	3/8	Brass	5	3.32	1.19	84.3	30.2
580	Socket/Female	1/2	1/2	Brass	5	3.24	1.19	82.3	30.2
590	Socket/Female	1/2	3/4	Brass	5	4.09	1.19	103.9	30.2
Part Number	Coupling Type	Body Size	Hose I.D.	Material	Fig.	Dimensions			
						C (in)	D (in)	C (mm)	D (mm)
585	Plug/Male	1/2	5/16	Steel	6	2.66	0.69	67.6	17.5
585G†	Plug/Male	1/2	5/16	Brass	6	3.37	0.98	85.6	24.9
59	Plug/Male	1/2	3/8	Steel	6	2.66	0.69	67.6	17.5
59G†	Plug/Male	1/2	3/8	Brass	6	3.37	0.98	85.6	24.9
60	Plug/Male	1/2	1/2	Steel	6	2.66	0.75	67.6	19.1
60G†	Plug/Male	1/2	1/2	Brass	6	3.37	0.98	85.6	24.9
61E	Plug/Male	1/2	3/4	Steel	6	3.50	1.00	88.9	25.4
61G†	Plug/Male	1/2	3/4	Brass	6	4.22	1.00	107.2	25.4

†With Bleeder Ball Check—Reduces Hose Whip

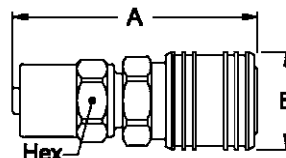

Figure 7

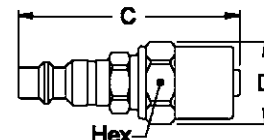

Figure 8

Hose Clamp End Connections

Part Number	Coupling Type	Body Size	Hose I.D.	Hose O.D.	Material	Fig.	Dimensions					
							A (in)	B (in)	Hex (in)	A (mm)	B (mm)	Hex (mm)
50SP13	Socket/Female	1/2	1/2	13/16	Brass	7	4.09	1.19	0.94	103.9	30.2	23.9
50SP15	Socket/Female	1/2	1/2	7/8	Brass	7	4.09	1.19	1.00	103.9	30.2	25.4
5019E	Socket/Female	1/2	1/2	1	Brass	7	4.09	1.26	1.13	103.9	32.0	28.7
50SR23	Socket/Female	1/2	3/4	1 1/8	Brass	7	4.22	1.19	1.25	107.2	30.2	31.8
50SR25	Socket/Female	1/2	3/4	1 3/16	Brass	7	4.22	1.19	1.31	107.2	30.2	33.3
50SR27	Socket/Female	1/2	3/4	1 1/4	Brass	7	4.22	1.19	1.38	107.2	30.2	35.1
Part Number	Coupling Type	Body Size	Hose I.D.	Hose O.D.	Material	Fig.	Dimensions					
							C (in)	D (in)	Hex (in)	C (mm)	D (mm)	Hex (mm)
5PB3	Plug/Male	1/2	1/4	1/2	Steel	8	2.81	0.70	0.63	71.4	17.8	16.0
5PB5	Plug/Male	1/2	1/4	9/16	Steel	8	2.81	0.77	0.69	71.4	19.6	17.5
5PB7	Plug/Male	1/2	1/4	5/8	Steel	8	2.81	0.84	0.75	71.4	21.3	19.1
5PD5	Plug/Male	1/2	3/8	9/16	Steel	8	2.94	0.77	0.69	74.7	19.6	17.5
5PD7	Plug/Male	1/2	3/8	5/8	Steel	8	2.94	0.84	0.75	74.7	21.3	19.1
5PD9	Plug/Male	1/2	3/8	11/16	Steel	8	2.94	0.91	0.81	74.7	23.1	20.6
5PD11	Plug/Male	1/2	3/8	3/4	Steel	8	2.94	0.98	0.88	74.7	24.9	22.4
5PD13	Plug/Male	1/2	3/8	13/16	Steel	8	2.94	1.05	0.94	74.7	26.7	23.9
5PP13	Plug/Male	1/2	1/2	13/16	Steel	8	3.62	1.05	0.94	91.9	26.7	23.9
5PP15	Plug/Male	1/2	1/2	7/8	Steel	8	3.62	1.12	1.00	91.9	28.4	25.4
5PR23	Plug/Male	1/2	3/4	1 1/8	Steel	8	3.75	1.40	1.25	95.3	35.6	31.8
5PR25	Plug/Male	1/2	3/4	1 3/16	Steel	8	3.75	1.47	1.31	95.3	37.3	33.3
5PR27	Plug/Male	1/2	3/4	1 1/4	Steel	8	3.75	1.54	1.38	95.3	39.1	35.1

G600 Series

ISO 6150 B Interchange

Pneumatic application



Danfoss Hansen G600 Series is a single shut-off compressed air coupling that interchanges with ISO 6150 B and US A-A-59439 Standards requirements. Nominal diameter is 5.5 mm. Its new revamped design and the materials used make it a rugged and long-lasting coupling, offered in a wide selection of end connections. It is used in general pneumatic applications.

Product Features

- Automatic sleeve for one-hand push-to-connect operation with ball-locking mechanism
- Single shut-off valving
- Excellent flow capacity
- Easy to connect
- Shock-resistant ergonomic sleeve
- Standard body material (Socket): Nickel-plated brass
- Standard body material (Plug): Zinc trivalent-plated steel
- Standard seal material: NBR
- Option: Private labelling

Physical Characteristics

Body Size	Nominal Flow Diameter (mm)	Max. Operating Pressure		Air Flow Rate*				Working Temperature	
		(bar)	(psi)	Δp 0.6 bar/8.7 psi** (lpm)	(gpm)	Δp 1 bar/14.5 psi*** (lpm)	(gpm)	°C	°F
1/4	5.5	20	290	1,050	277	1,315	347	-20° +100°	-4° +212°

*Indicated values refer to an inlet pressure of 6 bar / 87 psi.

**This flow rate allows the optimum output from a pneumatic tool.

*** This flow rate is the maximum recommended for a suitable output from a pneumatic tool. For applications needing higher flow rates, it is recommended to select a larger size coupling.

Applications & Markets

- Compressed Air
- Pneumatic Tools

Flow Data

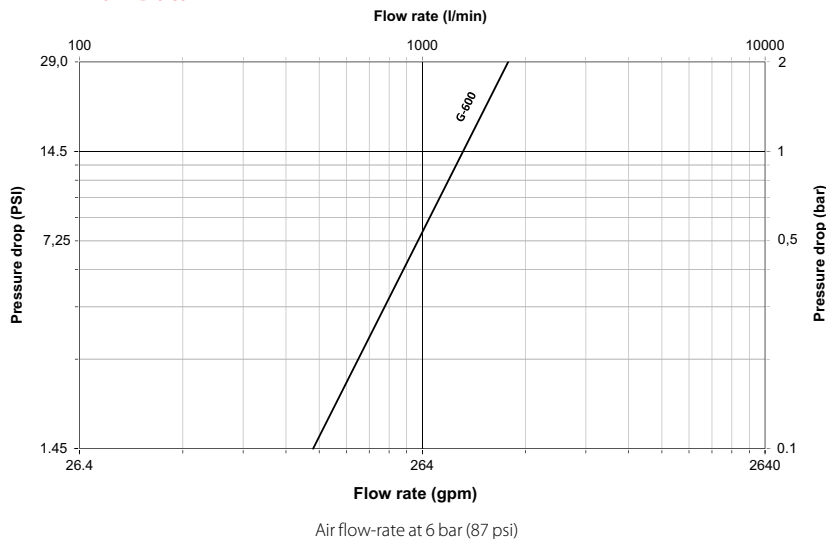

G600 Series

ISO 6150 B Interchange

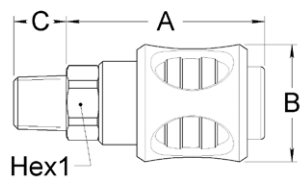

Figure 1

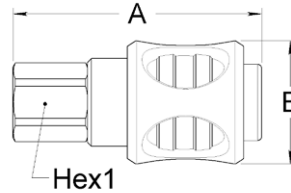

Figure 2

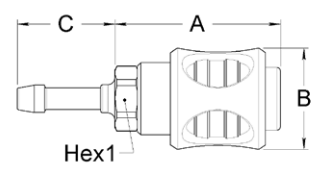

Figure 3

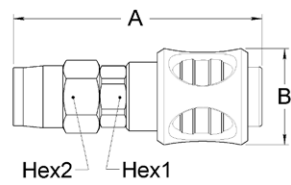

Figure 4

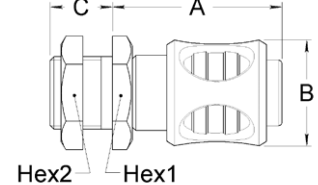

Figure 5

Sockets (Female)

Part Number	Body Size	Port Size	Thread or Hose Diam.*	Type	Fig.	Dimensions												
						A	B	C	Hex1	Hex2	A	B	C	Hex1	Hex2	Weight		
						(in)	(in)	(in)	(in)	(in)	(mm)	(mm)	(mm)	(mm)	(mm)	(mm)	lbs	g
GL0063614		¼	¼-19	Male BSPT	1	1.93	1.14	0.51	0.67	-	49	29	13	17	-	0.23	103	
GL0063638		¾	¾-19	Male BSPT	1	1.93	1.14	0.57	0.67	-	49	29	14.5	17	-	0.25	112	
GL0063612		½	½-14	Male BSPT	1	1.89	1.14	0.67	0.87	-	48	29	17	22	-	0.28	126	
GL0063645		M14	M14x1,25	Male Metric	1	1.93	1.14	0.51	0.67	-	49	29	13	17	-	0.23	105	
GL0062614		¼	¼-19	Female BSPP	2	2.30	1.14	-	0.67	-	58.5	29	-	17	-	0.22	102	
GL0062638		¾	¾-19	Female BSPP	2	2.42	1.14	-	0.87	-	61.5	29	-	22	-	0.27	121	
GL0062645		M14	M14x1,25	Female Metric	2	2.34	1.14	-	0.67	-	59.5	29	-	17	-	0.22	101	
GL0065667		-	6 mm	Hose Tail	3	1.87	1.14	1.10	0.67	-	47.5	29	28	17	-	0.22	99	
GL0065678	¼	-	7 mm	Hose Tail	3	1.87	1.14	1.10	0.67	-	47.5	29	28	17	-	0.22	101	
GL0065689		-	8 mm	Hose Tail	3	1.87	1.14	1.10	0.67	-	47.5	29	28	17	-	0.22	101	
GL0065690		-	9 mm	Hose Tail	3	1.87	1.14	1.10	0.67	-	47.5	29	28	17	-	0.22	102	
GL0065601		-	10 mm	Hose Tail	3	1.87	1.14	1.10	0.67	-	47.5	29	28	17	-	0.22	102	
GL0061674		-	7x14 mm	Reusable Hose Fit.	4	2.95	1.14	-	0.67	0.75	75	29	-	17	19	0.30	134	
GL0061684		-	8x14 mm	Reusable Hose Fit.	4	2.95	1.14	-	0.67	0.75	75	29	-	17	19	0.29	130	
GL0061685		-	8x15 mm	Reusable Hose Fit.	4	2.95	1.14	-	0.67	0.75	75	29	-	17	19	0.28	126	
GL0061696		-	9x16mm	Reusable Hose Fit.	4	2.95	1.14	-	0.67	0.75	75	29	-	17	19	0.28	128	
GL0065014		¼	¼-19	Female BSPPBulkhead**	5	1.83	1.14	0.67	1.06	1.06	46.5	29	17	27	27	0.33	148	

To obtain connected length of coupling add dimensions A or A+C (Fig. 1, 2, 3, 4, 5) and D or D+E (Fig. 6, 7, 8, 9, 10) together and subtract 20 mm (0.79 in.)

*Alternative end connections available upon request.

**Max bulkhead thickness: 10 mm (0.39 in.) / Bulkhead hole diameter: 21 mm (0.83 in.)

G600 Series

ISO 6150 B Interchange

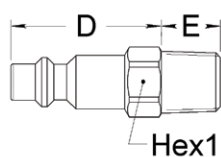

Figure 6

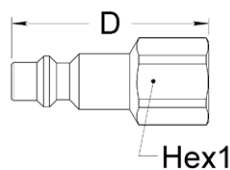

Figure 7



Figure 8

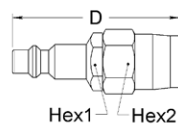

Figure 9

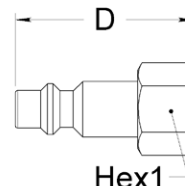

Figure 10

Plug (Male)

Part Number	Body Size	Port Size	Thread or Hose Diam*	Type	Fig.	Dimensions										Weight		
						D	E	F	Hex1	Hex2	D	E	F	Hex1	Hex2	lbs	g	
						(in)	(in)	(in)	(in)	(in)	(in)	(mm)	(mm)	(mm)	(mm)	(mm)		
GA0066318		3/8	3/8-28	Male BSPT	6	1.26	0.35	-	0.47	-	32	9	-	12	-	0.04	19	
GA0066314		1/4	1/4-19	Male BSPT	6	1.26	0.51	-	0.55	-	32	13	-	14	-	0.06	25	
10		1/4	1/4-18	Male NPT	6	1.22	0.55	-	0.59	-	31	14	-	15	-	0.06	25	
GA0066338		3/8	3/8-19	Male BSPT	6	1.26	0.59	-	0.67	-	32	15	-	17	-	0.08	38	
GA0066345		M14	M14x1,25	Male Metric	6	1.26	0.51	-	0.55	-	32	13	-	14	-	0.06	26	
GA0066214		1/4	1/4-19	Female BSPP	7	1.73	-	-	0.67	-	44	-	-	17	-	0.07	30	
11		1/4	1/4-18	Female NPT	7	1.63	-	-	0.71	-	41.5	-	-	18	-	0.07	30	
GA0066238		3/8	3/8-19	Female BSPP	7	1.73	-	-	0.83	-	44	-	-	21	-	0.08	37	
GA0066245		M14	M14x1,25	Female Metric	7	1.73	-	-	0.67	-	44	-	-	17	-	0.06	25	
GA0066248	1/4	-	M10,4x0,80	Female Metric	7	1.73	-	-	0.55	-	44	-	-	14	-	0.05	24	
GA0066767	-	-	6 mm	Hose Tail	8	1.10	1.02	0.55	-	-	28	26	14	-	-	0.04	19	
GA0066778	-	-	7 mm	Hose Tail	8	1.10	1.02	0.55	-	-	28	26	14	-	-	0.04	20	
GA0066789	-	-	8 mm	Hose Tail	8	1.10	1.02	0.55	-	-	28	26	14	-	-	0.04	20	
GA0066790	-	-	9 mm	Hose Tail	8	1.10	1.02	0.55	-	-	28	26	14	-	-	0.04	20	
GA0066701	-	-	10 mm	Hose Tail	8	1.10	1.02	0.55	-	-	28	26	14	-	-	0.05	22	
GA0066174	-	-	7x14 mm	Reusable Hose Fit.	9	2.22	-	-	0.63	0.75	56.5	-	-	16	19	0.12	56	
GA0066184	-	-	8x14 mm	Reusable Hose Fit.	9	2.22	-	-	0.63	0.75	56.5	-	-	16	19	0.13	57	
GA0066185	-	-	8x15 mm	Reusable Hose Fit.	9	2.22	-	-	0.63	0.75	56.5	-	-	16	19	0.12	53	
GA0066196	-	-	9x16 mm	Reusable Hose Fit.	9	2.22	-	-	0.63	0.75	56.5	-	-	16	19	0.11	51	
GA0066814		1/4	1/4-19	Female BSPP Swivel	10	1.50	-	-	0.67	-	38	-	-	17	-	0.06	26	
GA0066845		M14	M14x1,25	Female Metric Swivel	10	1.50	-	-	0.67	-	38	-	-	17	-	0.06	26	

To obtain connected length of coupling add dimensions A or A+C (Fig. 1, 2, 3, 4, 5) and D or D+E (Fig. 6, 7, 8, 9, 10) together and subtract 20 mm (0.79 in.)

*Alternative end connections available upon request.

I900 Series

ISO 6150 B Interchange

Pneumatic application

Danfoss Hansen I900 Series is a single shut-off compressed air coupling that interchanges with ISO 6150 B and US A-A-59439 Standards requirements. Nominal diameter is 8 mm.



Product Features

- Automatic sleeve for one-hand push-to-connect operation with ball-locking mechanism
- Single shut-off valving
- Excellent flow capacity
- Easy to connect
- Standard body material (Socket): Nickel-plated brass
- Standard body material (Plug): Zinc trivalent plated steel
- Standard seal material: NBR

Physical Characteristics

Body Size (in)	Nominal Flow Diameter (mm)	Max. Operating Pressure		Air Flow Rate* Δp 0.6 bar/8.7 psi**		Δp 1 bar/14.5 psi***		Working Temperature	
		(bar)	(psi)	(lpm)	(gpm)	(lpm)	(gpm)	°C	°F
3/8	8	20	290	2,200	580	2,700	710	-20° +100°	-4° +212°

*Indicated values refer to an inlet pressure of 6 bar/87 psi.

**This flow rate allows the optimum output from a pneumatic tool.

***This flow rate is the maximum recommended for a suitable output from a pneumatic tool. For applications needing higher flow rates, it is recommended to select a larger size coupling.

Applications & Markets

- Compressed Air
- Pneumatic Tools

Flow Data

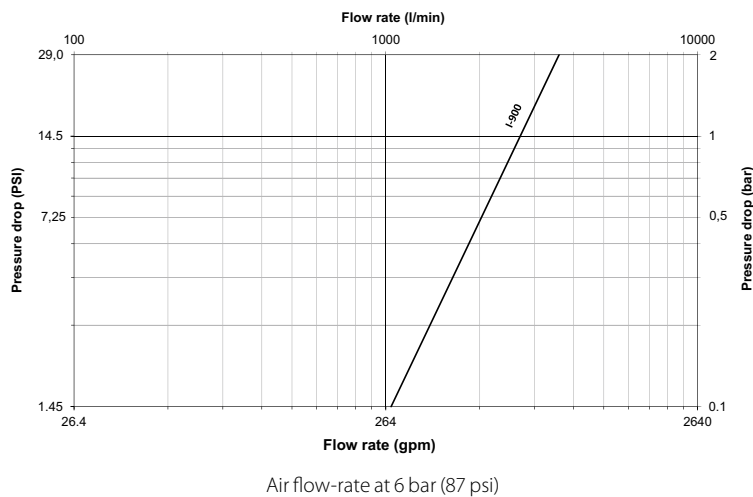

1900 Series

ISO 6150 B Interchange

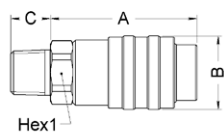

Figure 1

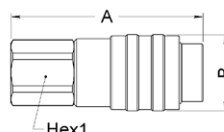

Figure 2

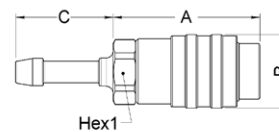

Figure 3

Sockets (Female)

Part Number	Body Size	Port Size	Thread or Hose Diam.*	Type	Fig.	Dimensions						Weight			
						A	B	C	Hex1	A	B	C	Hex1	lbs	g
						(in)	(in)	(in)	(in)	(mm)	(mm)	(mm)	(mm)		
IL0096014		1/4	1/4-19	Male BSPT	1	2.16	1.09	0.51	0.87	55	27.7	13	22	0.30	135
IL0096038		3/8	3/8-19	Male BSPT	1	2.16	1.09	0.59	0.87	55	27.7	15	22	0.31	139
IL0096012		1/2	1/2-14	Male BSPT	1	2.16	1.09	0.67	0.87	55	27.7	17	22	0.34	152
IL0097014		1/4	1/4-19	Female BSPP	2	2.64	1.09	-	0.87	67	27.7	-	22	0.34	153
IL0097038	3/8	3/8	3/8-19	Female BSPP	2	2.76	1.09	-	0.87	70	27.7	-	22	0.35	157
IL0097012		1/2	1/2-14	Female BSPP	2	2.87	1.09	-	1.06	73	27.7	-	27	0.41	187
IL0095689		-	8 mm	Hose Tail	3	2.20	1.09	1.10	0.87	56	27.7	28	22	0.30	135
IL0095690		-	9 mm	Hose Tail	3	2.20	1.09	1.10	0.87	56	27.7	28	22	0.30	138
IL0095601		-	10 mm	Hose Tail	3	2.20	1.09	1.10	0.87	56	27.7	28	22	0.31	139

To obtain connected length of coupling add dimensions A or A+C (Fig. 1, 2, 3) and D or D+E (Fig. 4, 5, 6) together and subtract 25,6 mm (1 in.)

*Alternative end connections available upon request.

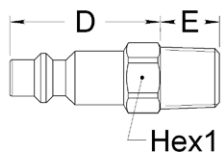

Figure 4

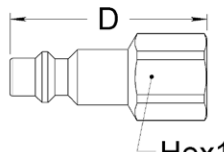

Figure 5

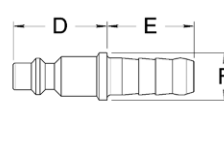

Figure 6

Plugs (Male)

Part Number	Body Size	Port Size	Thread or Hose Diam.*	Type	Fig.	Dimensions			Hex1	D	E	F	Hex1	Weight	
						D	E	F						(mm)	(mm)
						(in)	(in)	(in)	(in)	(mm)	(mm)	(mm)	(mm)		
IA0090614		1/4	1/4-19	Male BSPT	4	1.34	0.51	-	0.63	34	13	-	16	0.07	32
IA0090638		3/8	3/8-19	Male BSPT	4	1.42	0.59	-	0.67	36	15	-	17	0.09	41
IA0090612		1/2	1/2-14	Male BSPT	4	1.57	0.67	-	0.91	40	17	-	23	0.12	56
IA0090714		1/4	1/4-19	Female BSPP	5	1.97	-	-	0.67	50	-	-	17	0.08	38
IA0090738		3/8	3/8-19	Female BSPP	5	1.97	-	-	0.83	50	-	-	21	0.11	49
IA0090712	3/8	1/2	1/2-14	Female BSPP	5	2.09	-	-	1.02	53	-	-	26	0.15	69
IA0090978		-	7 mm	Hose Tail	6	1.30	1.02	0.63	-	33	26	16	-	0.07	30
IA0090989		-	8 mm	Hose Tail	6	1.30	1.02	0.63	-	33	26	16	-	0.07	30
IA0090990		-	9 mm	Hose Tail	6	1.30	1.02	0.63	-	33	26	16	-	0.07	31
IA0090901		-	10 mm	Hose Tail	6	1.30	1.02	0.63	-	33	26	16	-	0.07	32
IA0090912		-	12 mm	Hose Tail	6	1.30	1.22	0.63	-	33	31	16	-	0.08	38

To obtain connected length of coupling add dimensions A or A+C (Fig. 1, 2, 3) and D or D+E (Fig. 4, 5, 6) together and subtract 25,6 mm (1 in.)

*Alternative end connections available upon request.

T1100 Series

ISO 6150 B Interchange

Pneumatic application

Danfoss Hansen T1100 Series is a single shut-off compressed air coupling that interchanges with ISO 6150 B and US A-A-59439 Standards requirements. This coupling offers excellent flow capacity and is used in many compressed air applications.



Product Features

- Automatic sleeve for one-hand push-to-connect operation with ball-locking mechanism
- Single shut-off valving
- Excellent flow capacity
- Easy to connect
- Standard body material (Socket): Nickel-plated brass
- Standard body material (Plug): Zinc trivalent plated steel
- Standard seal material: NBR

Physical Characteristics

Body Size (in)	Nominal Flow Diameter (mm)	Max. Operating Pressure		Air Flow Rate* Δp 0.6 bar/8.7 psi**		Δp 1 bar/14.5 psi***		Working Temperature	
		(bar)	(psi)	(lpm)	(gpm)	(lpm)	(gpm)	°C	°F
1/2	11	20	290	3,450	910	4,300	1,130	-20° +100°	-4° +212°

*Indicated values refer to an inlet pressure of 6 bar/87 psi.

**This flow rate allows the optimum output from a pneumatic tool.

***This flow rate is the maximum recommended for a suitable output from a pneumatic tool. For applications needing higher flow rates, it is recommended to select a larger size coupling.

Applications & Markets

- Compressed Air
- Pneumatic Tools

Flow Data

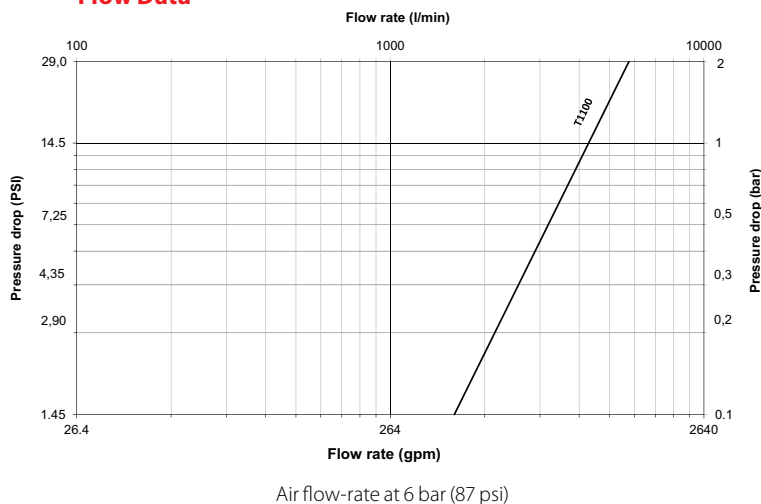

T1100 Series

ISO 6150 B Interchange

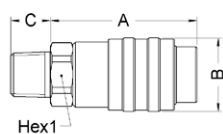

Figure 1

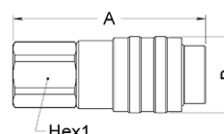

Figure 2

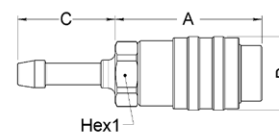

Figure 3

Sockets (Female)

Part Number	Body Size	Port Size	Thread or Hose Diam.*	Type	Dimensions Fig.	Dimensions			Hex1 (in)	A (mm)	B (mm)	C (mm)	Hex1 (mm)	Weight	
						A (in)	B (in)	C (in)						lbs	g
TL0112038		3/8	3/8-19	Male BSPT	1	2.80	1.32	0.59	1.06	71	33.6	15	27	0.58	265
TL0112012		1/2	1/2-14	Male BSPT	1	2.80	1.32	0.67	1.06	71	33.6	17.0	27	0.60	270
TL0112034		3/4	3/4-14	Male BSPT	1	2.80	1.32	0.73	1.14	71	33.6	18.5	29	0.63	288
TL0112138		3/8	3/8-19	Female BSPP	2	3.29	1.32	-	1.06	83.5	33.6	-	27	0.63	286
TL0112112	1/2	1/2	1/2-14	Female BSPP	2	3.29	1.32	-	1.06	83.5	33.6	-	27	0.59	266
TL0112134		3/4	3/4-14	Female BSPP	2	3.52	1.32	-	1.26	89.5	33.6	-	32	0.69	312
TL0115601		-	10 mm	Hose Tail	3	2.85	1.32	1.10	1.06	72.5	33.6	28	27	0.58	264
TL0115613		-	13 mm	Hose Tail	3	2.85	1.32	1.30	1.06	72.5	33.6	33	27	0.60	274
TL0115616		-	16 mm	Hose Tail	3	2.85	1.32	1.30	1.06	72.5	33.6	33	27	0.62	279

To obtain connected length of coupling add dimensions A or A+C (Fig. 1, 2, 3) and D or D+E (Fig. 4, 5, 6) together and subtract 34 mm (1,34 in.)

*Alternative end connections available upon request.

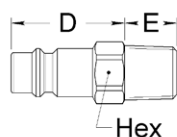

Figure 4

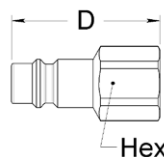

Figure 5

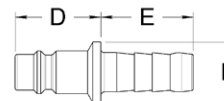

Figure 6

Plugs (Male)

Part Number	Body Size	Port Size	Thread or Hose Diam.*	Type	Dimensions Fig.	Dimensions			Hex1 (in)	D (mm)	E (mm)	F (mm)	Hex1 (mm)	Weight	
						D (in)	E (in)	F (in)						lbs	g
TA0111538		3/8	3/8-19	Male BSPT	4	1.71	0.57	-	0.67	43.5	14.5	-	17	0.11	51
TA0111512		1/2	1/2-14	Male BSPT	4	1.81	0.67	-	0.87	46	17	-	22	0.15	70
TA0111638		3/8	3/8-19	Female BSPP	5	2.09	-	-	0.83	53	-	-	21	0.12	55
TA0111612	1/2	1/2	1/2-14	Female BSPP	5	2.28	-	-	1.06	58	-	-	27	0.19	88
TA0111813		-	13 mm	Hose Tail	6	1.54	1.02	0.75	-	39	26	19	-	0.09	43
TA0111816		-	16 mm	Hose Tail	6	1.54	1.02	0.87	-	39	26	22	-	0.10	47
TA0111819		-	19 mm	Hose Tail	6	1.54	1.02	0.98	-	39	26	25	-	0.11	51

To obtain connected length of coupling add dimensions A or A+C (Fig. 1, 2, 3) and D or D+E (Fig. 4, 5, 6) together and subtract 34 mm (1,34 in.)

*Alternative end connections available upon request.

T1300 Series

Proprietary Profile

Pneumatic application

Danfoss Hansen T1300 Series is a proprietary profile single shut-off compressed air coupling. This coupling offers excellent flow capacity and is used in high flow compressed air applications.



Product Features

- Automatic sleeve for one-hand push-to-connect operation with ball-locking mechanism
- Single shut-off valving
- Excellent flow capacity
- Easy to connect
- Standard body material (Socket): Nickel-plated brass
- Standard body material (Plug): Zinc trivalent plated steel
- Standard seal material: NBR

Physical Characteristics

Body Size (in)	Nominal Flow Diameter (mm)	Max. Operating Pressure		Air Flow Rate* Δp 0.6 bar/8.7 psi**		Δp 1 bar/14.5 psi***		Working Temperature	
		(bar)	(psi)	(lpm)	(gpm)	(lpm)	(gpm)	°C	°F
1/2	12	20	290	3,800	1,000	4,600	1,210	-20° +100°	-4° +212°

*Indicated values refer to an inlet pressure of 6 bar / 87 psi.

**This flow rate allows the optimum output from a pneumatic tool.

***This flow rate is the maximum recommended for a suitable output from a pneumatic tool. For applications needing higher flow rates, it is recommended to select a larger size coupling.

Applications & Markets

- Compressed Air
- Pneumatic Tools

Flow Data

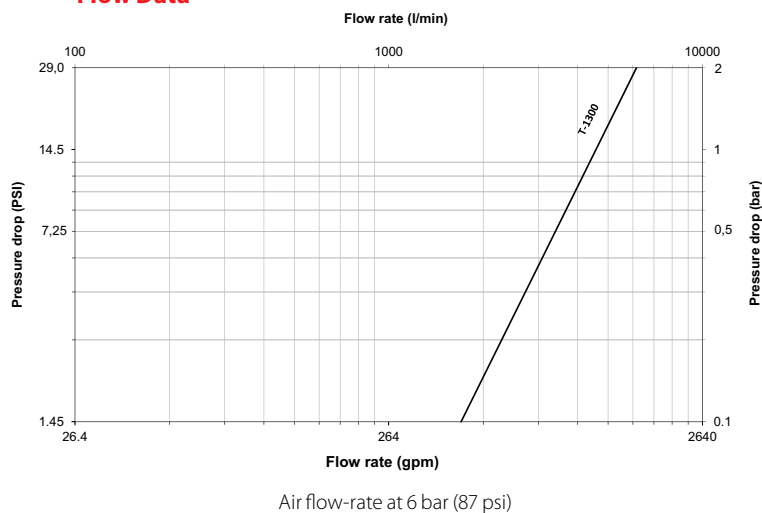

T1300 Series

Proprietary Profile

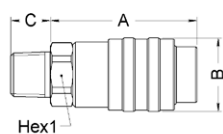

Figure 1

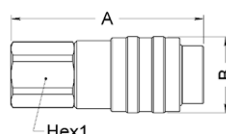

Figure 2

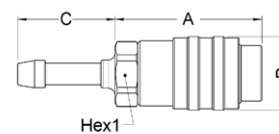

Figure 3

Sockets (Female)

Part Number	Body Size	Port Size	Thread or Hose Diam.*	Type	Fig.	Dimensions									
						A	B	C	Hex1	A	B	C	Hex1	Weight	
						(in)	(in)	(in)	(in)	(mm)	(mm)	(mm)	(mm)	lbs	g
TL0132038		3/8	3/8-19	Male BSPT	1	2.74	1.32	0.59	1.06	69.7	33.6	15	27	0.54	247
TL0132012		1/2	1/2-14	Male BSPT	1	2.74	1.32	0.67	1.06	69.7	33.6	17.0	27	0.56	255
TL0132034		3/4	3/4-14	Male BSPT	1	2.74	1.32	0.73	1.14	69.7	33.6	18.5	29	0.62	279
TL0132138		3/8	3/8-19	Female BSPP	2	3.24	1.32	-	1.06	82.2	33.6	-	27	0.60	272
TL0132112	1/2	1/2	1/2-14	Female BSPP	2	3.24	1.32	-	1.06	82.2	33.6	-	27	0.60	270
TL0132134		3/4	3/4-14	Female BSPP	2	3.47	1.32	-	1.26	88.2	33.6	-	32	0.65	295
TL0135601		-	10 mm	Hose Tail	3	2.80	1.32	1.10	1.06	71.2	33.6	28	27	0.55	249
TL0135613		-	13 mm	Hose Tail	3	2.80	1.32	1.30	1.06	71.2	33.6	33	27	0.57	259
TL0135616		-	16 mm	Hose Tail	3	2.80	1.32	1.30	1.06	71.2	33.6	33	27	0.58	264

To obtain connected length of coupling add dimensions A or A+C (Fig. 1, 2, 3) and D or D+E (Fig. 4, 5, 6) together and subtract 32,5 mm (1,28 in.)

*Alternative end connections available upon request.

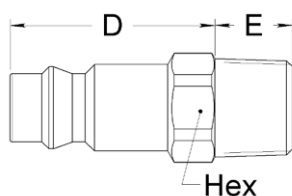

Figure 4

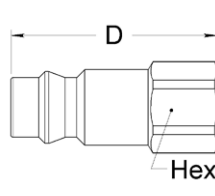

Figure 5

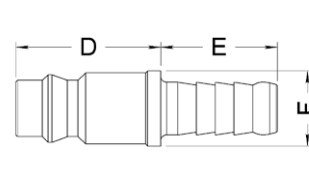

Figure 6

Plugs (Male)

Part Number	Body Size	Port Size	Thread or Hose Diam.*	Type	Fig.	Dimensions									
						D	E	F	Hex1	D	E	F	Hex1	Weight	
						(in)	(in)	(in)	(in)	(mm)	(mm)	(mm)	(mm)	lbs	g
TA0131538		3/8	3/8-19	Male BSPT	4	1.75	0.59	-	0.83	44.5	15	-	21	0.14	65
TA0131512		1/2	1/2-14	Male BSPT	4	1.83	0.67	-	0.87	46.5	17	-	22	0.19	85
TA0131638		3/8	3/8-19	Female BSPP	5	2.17	-	-	0.83	55	-	-	21	0.14	65
TA0131612	1/2	1/2	1/2-14	Female BSPP	5	2.48	-	-	1.02	63	-	-	26	0.21	95
TA0131813		-	13 mm	Hose Tail	6	1.52	1.22	0.79	-	38.5	31	20	-	0.13	57
TA0131816		-	16 mm	Hose Tail	6	1.52	1.46	0.79	-	38.5	37	20	-	0.15	70
TA0131819		-	19 mm	Hose Tail	6	1.52	1.65	1.06	-	38.5	42	27	-	0.19	87

To obtain connected length of coupling add dimensions A or A+C (Fig. 1, 2, 3) and D or D+E (Fig. 4, 5, 6) together and subtract 32,5 mm (1,28 in.)

*Alternative end connections available upon request.

3000/4000/5000/6000 Series

Pneumatic application



Danfoss Hansen 3000/4000/5000/6000 Series Industrial Interchange pin lock pneumatic quick disconnect couplings are designed for compressed air, gases, and liquids. This series sets the industry standard for pin lock style pneumatic couplings.

Product Features

- Easy, automatic, push-to-connect design provides instantaneous connection and disconnection of lines, plus automatic shut-off of socket/female end of line
- All sizes accept US industrial Interchange; 1/4" & 1/2" also accept ISO 6150 Series B and A-A-59439 plugs/males
- Optional sleeve lock option prevents accidental disconnection
- Standard body material: Brass
- Standard seal material: Buna-N
- Optional seal and valve materials: Silicone-138, FKM-143, EPDM-192

Physical Characteristics

Series	Body Size (in)	Max. Operating Pressure		Min. Burst Pressure		Rated Flow	
		(bar)	(psi)	(bar)	(psi)	(lpm)	scfm
3000	1/4	138	2,000	552	8,000	680	24
4000	3/8	69	1,000	276	4,000	1,274	45
5000	1/2	35	500	140	2,000	2,040	72
6000	3/4	15	220	60	880	3,540	125

Applications & Markets

- Industrial Breathing Air
- General Pneumatics
- Maintenance & Repair
- Fluid Transfer

Interchangeability

All Sizes	1/4" & 1/2"
US Industrial Interchange	ISO 6150 Series B A-A-59439 (former MIL-C-4109)

Flow Data

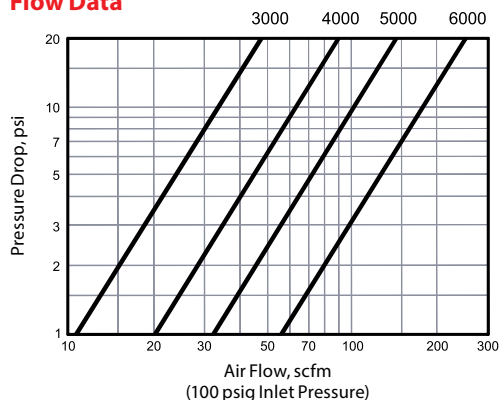

3000 Series

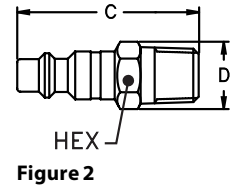
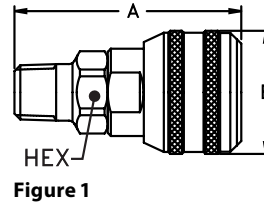

Male End Connections

Part Number	Coupling Type	Body Size	Port Size	Thread	Type	Material	Fig.	Dimensions			Hex	A	B	Hex	
								A	B	Hex					
								(in)	(in)	(in)	(mm)	(mm)	(mm)		
2900	Socket/Female	1/4	1/8	1/8-27	NPTF	Brass	1	2.00	1.19	0.69	50.80	30.23	17.53		
3100E	Socket/Female	1/4	1/4	1/4-18	NPTF	Brass	1	2.19	1.19	0.69	55.63	30.23	17.53		
3300E	Socket/Female	1/4	3/8	3/8-18	NPTF	Brass	1	2.15	1.19	0.69	54.61	30.23	17.53		
300043*	Socket/Female	1/4	7/16	7/16-20	UNF	Brass	1	2.10	1.19	0.69	53.34	30.23	17.53		
Part Number	Coupling Type	Body Size	Port Size	Thread	Type	Material	Fig.	Dimensions			Hex	C	D	Hex	
								C	D	Hex					
								(in)	(in)	(in)	(mm)	(mm)	(mm)		
10	Plug/Male	1/4	1/4	1/4-18	NPTF	Steel	2	1.75	0.62	0.56	44.45	15.85	14.22		
10CS	Plug/Male	1/4	1/4	1/4-18	NPTF	Steel	2	1.75	0.65	0.56	44.45	16.51	14.22		
10G†	Plug/Male	1/4	1/4	1/4-18	NPTF	Steel	2	1.75	0.65	0.56	44.45	16.51	14.22		
12E	Plug/Male	1/4	1/8	1/8-27	NPTF	Steel	2	1.59	0.58	0.50	40.39	14.73	12.70		
12G†	Plug/Male	1/4	1/8	1/8-27	NPTF	Steel	2	2.38	0.77	0.69	60.45	19.56	17.53		
14	Plug/Male	1/4	3/8	3/8-18	NPTF	Steel	2	1.75	0.79	0.69	44.45	20.07	17.53		
14G†	Plug/Male	1/4	3/8	3/8-18	NPTF	Steel	2	2.53	0.77	0.69	64.26	19.56	17.53		
B10	Plug/Male	1/4	1/4	1/4-18	NPTF	Brass	2	1.75	0.62	0.56	44.45	15.75	14.22		
LL10	Plug/Male	1/4	1/4	1/4-18	NPTF	Stainless	2	1.75	0.62	0.56	44.45	15.85	14.22		
10NK**	Plug/Male	1/4	1/4	1/4-18	NPTF	Steel	2	1.75	0.62	0.56	44.45	15.75	14.22		

*45° Male Flare †With Ball Check ‡With Bleeder Ball Check—Reduces Hose Whip **Nickel plated

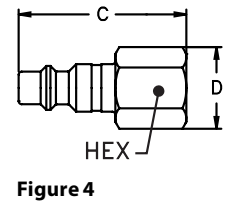
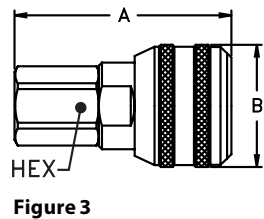

Female End Connections

Part Number	Coupling Type	Body Size	Port Size	Thread	Type	Material	Fig.	Dimensions			Hex	A	B	Hex	
								A	B	Hex					
								(in)	(in)	(in)	(mm)	(mm)	(mm)		
2800	Socket/Female	1/4	1/8	1/8-27	NPTF	Brass	3	1.89	1.19	0.69	48.01	30.23	17.53		
3000	Socket/Female	1/4	1/4	1/4-18	NPTF	Brass	3	2.11	1.19	0.69	53.59	30.23	17.53		
3200	Socket/Female	1/4	3/8	3/8-18	NPTF	Brass	3	2.19	1.19	0.75	55.63	30.23	19.05		
Part Number	Coupling Type	Body Size	Port Size	Thread	Type	Material	Fig.	Dimensions			Hex	C	D	Hex	
								C	D	Hex					
								(in)	(in)	(in)	(mm)	(mm)	(mm)		
11	Plug/Male	1/4	1/4	1/4-18	NPTF	Steel	4	1.63	0.79	0.69	41.40	20.07	17.53		
11G†	Plug/Male	1/4	1/4	1/4-18	NPTF	Steel	4	2.44	0.77	0.69	61.98	19.56	17.53		
13	Plug/Male	1/4	1/8	1/8-27	NPTF	Steel	4	1.47	0.65	0.56	37.34	16.51	14.22		
15E	Plug/Male	1/4	3/8	3/8-18	NPTF	Steel	4	1.69	0.94	0.81	42.93	23.88	20.57		
11B	Plug/Male	1/4	1/4	1/4-18	NPTF	Brass	4	1.63	0.79	0.69	41.40	20.07	17.53		
LL11	Plug/Male	1/4	1/4	1/4-18	NPTF	Stainless	4	1.63	0.79	0.69	41.40	20.07	17.53		
11NK*	Plug/Male	1/4	1/4	1/4-18	NPTF	Steel	4	1.63	0.79	0.69	41.40	20.07	17.53		

†With Bleeder Ball Check—Reduces Hose Whip *Nickel plated

3000 Series

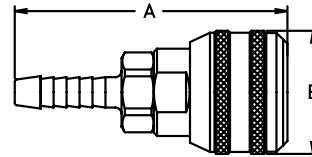

Figure 5

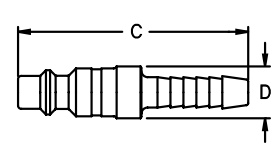

Figure 6

Hose Stem End Connections

Part Number	Coupling Type	Body Size	Hose I.D.	Material	Fig.	Dimensions		A	B
						A	B		
						(in)	(in)	(mm)	(mm)
3600	Socket/Female	1/4	1/4	Brass	5	2.63	1.19	66.80	30.23
3600P‡	Socket/Female	1/4	1/4	Brass	5,5A	2.40	1.19	60.96	30.23
3700E	Socket/Female	1/4	3/8	Brass	5	2.63	1.19	66.80	30.23
3700P‡	Socket/Female	1/4	3/8	Brass	5,5A	2.47	1.19	62.74	30.23
3800	Socket/Female	1/4	5/16	Brass	5	2.63	1.19	66.80	30.23
Part Number	Coupling Type	Body Size	Hose I.D.	Material	Fig.	Dimensions		C	D
						C	D		
						(in)	(in)	(mm)	(mm)
16	Plug/Male	1/4	1/4	Steel	6	2.22	0.50	56.39	12.70
16G†	Plug/Male	1/4	1/4	Steel	6	2.97	0.77	75.44	19.56
16P‡	Plug/Male	1/4	1/4	Steel	6,6A	2.00	0.58	50.80	14.73
17	Plug/Male	1/4	3/8	Steel	6	2.22	0.50	56.39	12.70
17G†	Plug/Male	1/4	3/8	Steel	6	2.96	0.77	75.18	19.56
17P‡	Plug/Male	1/4	3/8	Steel	6,6A	2.06	0.5	52.32	12.70
18E	Plug/Male	1/4	5/16	Steel	6	2.22	0.50	56.39	12.70
B17	Plug/Male	1/4	3/8	Brass	6	2.22	0.50	56.39	12.70
16NK*	Plug/Male	1/4	1/4	Steel	6	2.22	0.5	56.39	12.70
17NK*	Plug/Male	1/4	3/8	Steel	6	2.22	0.5	56.39	12.70

†With Bleeder Ball Checkv—Reduces Hose Whip ‡ For use with push-on style hose *Nickel plated

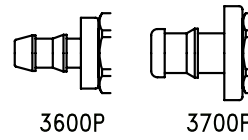

Figure 5A

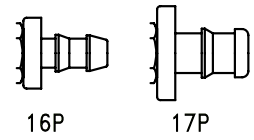

Figure 6A

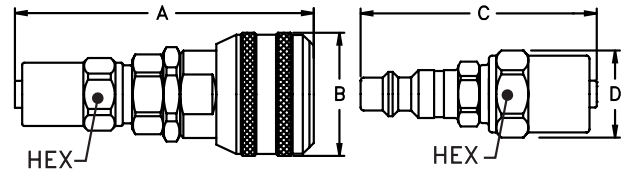

Figure 7

Figure 8

Hose Clamp End Connections

Part Number	Coupling Type	Body Size	Hose I.D.	Hose O.D.	Material	Fig.	Dimensions			A	B	Hex
							A	B	Hex			
							(in)	(in)	(in)	(mm)	(mm)	(mm)
3SA0	Socket/Female	1/4	3/16	7/16	Brass	7	2.65	1.19	0.56	67.31	30.23	14.22
3SB1	Socket/Female	1/4	1/4	15/32	Brass	7	2.72	1.19	0.63	69.09	30.23	16.00
3SB3	Socket/Female	1/4	1/4	1/2	Brass	7	2.72	1.19	0.63	69.09	30.23	16.00
3SB5	Socket/Female	1/4	1/4	9/16	Brass	7	2.72	1.19	0.69	69.09	30.23	17.53
3SB7	Socket/Female	1/4	1/4	5/8	Brass	7	2.72	1.19	0.75	69.09	30.23	19.05
3SB9	Socket/Female	1/4	1/4	11/16	Brass	7	2.72	1.19	0.81	69.09	30.23	20.57
3SC5	Socket/Female	1/4	5/16	9/16	Brass	7	2.78	1.19	0.69	70.61	30.23	17.53
3SC7	Socket/Female	1/4	5/16	5/8	Brass	7	2.78	1.19	0.75	70.61	30.23	19.05
3SC9	Socket/Female	1/4	5/16	11/16	Brass	7	2.78	1.19	0.81	70.61	30.23	20.57
3SD5	Socket/Female	1/4	3/8	9/16	Brass	7	2.84	1.19	0.69	72.14	30.23	17.53
3SD7	Socket/Female	1/4	3/8	5/8	Brass	7	2.84	1.19	0.75	72.14	30.23	19.05
3SD9	Socket/Female	1/4	3/8	11/16	Brass	7	2.84	1.19	0.81	72.14	30.23	20.57
3SD11	Socket/Female	1/4	3/8	3/4	Brass	7	2.84	1.19	0.88	72.14	30.23	22.35
Part Number	Coupling Type	Body Size	Hose I.D.	Hose O.D.	Material	Fig.	Dimensions			C	D	Hex
							C	D	Hex			
							(in)	(in)	(in)	(mm)	(mm)	(mm)
3PB1	Plug/Male	1/4	1/4	15/32	Steel	8	2.31	0.70	0.63	58.67	17.78	16.00
3PB3	Plug/Male	1/4	1/4	1/2	Steel	8	2.31	0.70	0.63	58.67	17.78	16.00
3PB5	Plug/Male	1/4	1/4	9/16	Steel	8	2.31	0.77	0.69	58.67	19.56	17.53
3PB7	Plug/Male	1/4	1/4	5/8	Steel	8	2.31	0.84	0.75	58.67	21.34	19.05
3PB9	Plug/Male	1/4	1/4	11/16	Steel	8	2.31	0.91	0.81	58.67	23.11	20.57
3PB11	Plug/Male	1/4	1/4	3/4	Steel	8	2.31	0.98	0.88	58.67	24.89	22.35
3PC5	Plug/Male	1/4	5/16	9/16	Steel	8	2.38	0.77	0.69	60.45	19.56	17.53
3PC7	Plug/Male	1/4	5/16	5/8	Steel	8	2.38	0.84	0.75	60.45	21.34	19.05
3PC9	Plug/Male	1/4	5/16	11/16	Steel	8	2.38	0.91	0.81	60.45	23.11	20.57
3PD5	Plug/Male	1/4	3/8	9/16	Steel	8	2.44	0.77	0.69	61.98	19.56	17.53
3PD7	Plug/Male	1/4	3/8	5/8	Steel	8	2.44	0.84	0.75	61.98	21.34	19.05
3PD9	Plug/Male	1/4	3/8	11/16	Steel	8	2.44	0.91	0.81	61.98	23.11	20.57
3PD11	Plug/Male	1/4	3/8	3/4	Steel	8	2.44	0.98	0.88	61.98	24.89	22.35

4000 Series

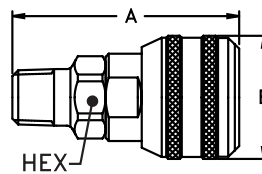

Figure 1

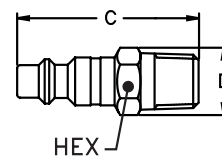

Figure 2

Male End Connections

Part Number	Coupling Type	Body Size	Port Size	Thread	Type	Material	Fig.	Dimensions			Hex	A	B	Hex
								A	B	Hex				
								(in)	(in)	(in)				
4100A	Socket/Female	3/8	1/8	1/8-27	NPTF	Brass	1	2.20	1.38	0.88	55.88	35.05	22.35	
4100	Socket/Female	3/8	1/4	1/4-18	NPTF	Brass	1	2.35	1.38	0.88	59.69	35.05	22.35	
4300	Socket/Female	3/8	3/8	3/8-18	NPTF	Brass	1	2.35	1.38	0.88	59.69	35.05	22.35	
4500E	Socket/Female	3/8	1/2	1/2-14	NPTF	Brass	1	2.54	1.38	0.88	64.52	35.05	22.35	

Part Number	Coupling Type	Body Size	Port Size	Thread	Type	Material	Fig.	Dimensions			Hex	C	D	Hex
								C	D	Hex				
								(in)	(in)	(in)				
38	Plug/Male	3/8	1/8	1/8-27	NPTF	Steel	2	1.72	0.72	0.63	43.69	18.29	16.00	
40	Plug/Male	3/8	1/4	1/4-18	NPTF	Steel	2	1.88	0.72	0.63	47.75	18.29	16.00	
40G†	Plug/Male	3/8	1/4	1/4-18	NPTF	Steel	2	2.65	0.77	0.69	67.31	19.56	17.53	
42	Plug/Male	3/8	3/8	3/8-18	NPTF	Steel	2	1.88	0.79	0.69	47.75	20.07	17.53	
42G†	Plug/Male	3/8	3/8	3/8-18	NPTF	Steel	2	2.65	0.77	0.69	67.31	19.56	17.53	
44	Plug/Male	3/8	1/2	1/2-14	NPTF	Steel	2	2.09	1.01	0.88	53.09	25.65	22.35	
B40	Plug/Male	3/8	1/4	1/4-18	NPTF	Brass	2	1.88	0.70	0.63	47.75	17.78	16.00	
B42	Plug/Male	3/8	3/8	3/8-18	NPTF	Brass	2	1.88	0.77	0.69	47.75	19.56	17.53	
40NK*	Plug/Male	3/8	1/4	1/4-18	NPTF	Steel	2	1.88	0.72	0.63	47.75	18.29	16.00	

†With Bleeder Ball Check—Reduces Hose Whip *Nickel plated

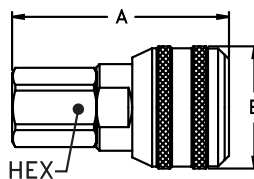

Figure 3

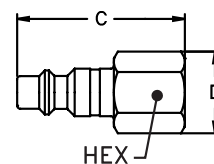

Figure 4

Female End Connections

Part Number	Coupling Type	Body Size	Port Size	Thread	Type	Material	Fig.	Dimensions			Hex	A	B	Hex
								A	B	Hex				
								(in)	(in)	(in)				
4000A	Socket/Female	3/8	1/8	1/8-27	NPTF	Brass	3	2.10	1.38	0.88	53.34	35.05	22.35	
4000	Socket/Female	3/8	1/4	1/4-18	NPTF	Brass	3	2.10	1.38	0.88	53.34	35.05	22.35	
4200	Socket/Female	3/8	3/8	3/8-18	NPTF	Brass	3	2.35	1.38	0.88	59.69	35.05	22.35	
4400	Socket/Female	3/8	1/2	1/2-14	NPTF	Brass	3	2.62	1.38	1	66.55	35.05	25.40	

Part Number	Coupling Type	Body Size	Port Size	Thread	Type	Material	Fig.	Dimensions			Hex	C	D	Hex
								C	D	Hex				
								(in)	(in)	(in)				
41	Plug/Male	3/8	1/4	1/4-18	NPTF	Steel	4	1.63	0.79	0.69	41.40	20.07	17.53	
41G†	Plug/Male	3/8	1/4	1/4-18	NPTF	Steel	4	2.56	0.77	0.69	65.02	19.56	17.53	
43	Plug/Male	3/8	3/8	3/8-18	NPTF	Steel	4	1.81	0.94	0.81	45.97	23.88	20.57	
43G†	Plug/Male	3/8	3/8	3/8-18	NPTF	Steel	4	2.62	0.84	0.75	66.55	21.34	19.05	
45E	Plug/Male	3/8	1/2	1/2-14	NPTF	Steel	4	2.06	1.15	1	52.32	29.21	25.40	
B43	Plug/Male	3/8	3/8	3/8-18	NPTF	Brass	4	1.81	0.91	0.81	45.97	23.11	20.57	
41NK*	Plug/Male	3/8	1/4	1/4-18	NPTF	Steel	4	1.63	0.79	0.69	41.40	20.07	17.53	

†With Bleeder Ball Check—Reduces Hose Whip *Nickel plated

4000 Series

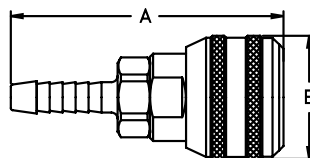

Figure 5

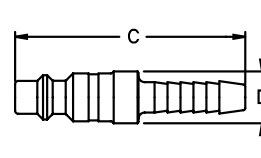

Figure 6

Hose Stem End Connections

Part Number	Coupling Type	Body Size	Hose I.D.	Material	Fig.	Dimensions			
						A	B	A	B
						(in)	(in)	(mm)	(mm)
40400E	Socket/Female	3/8	1/4	Brass	5	2.82	1.38	71.63	35.05
40500E	Socket/Female	3/8	5/16	Brass	5	2.82	1.38	71.63	35.05
40600	Socket/Female	3/8	3/8	Brass	5	2.82	1.38	71.63	35.05
40800	Socket/Female	3/8	1/2	Brass	5	2.82	1.38	71.63	35.05

Part Number	Coupling Type	Body Size	Hose I.D.	Material	Fig.	Dimensions			
						C	D	C	D
						(in)	(in)	(mm)	(mm)
404	Plug/Male	3/8	1/4	Steel	6	2.34	0.72	59.44	18.29
406	Plug/Male	3/8	3/8	Steel	6	2.34	0.63	59.44	16.00
408	Plug/Male	3/8	1/2	Steel	6	2.34	0.81	59.44	20.57
B406E	Plug/Male	3/8	3/8	Brass	6	2.34	0.63	59.44	16.00

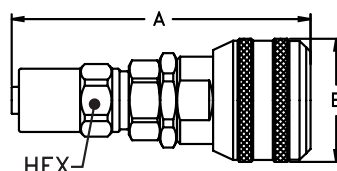

Figure 7

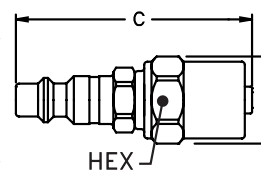

Figure 8

Hose Clamp End Connections

Part Number	Coupling Type	Body Size	Hose I.D.	Hose O.D.	Material	Fig.	Dimensions					
							A	B	Hex	A	B	Hex
							(in)	(in)	(in)	(mm)	(mm)	(mm)
4SB3	Socket/Female	3/8	1/4	1/2	Brass	7	2.92	1.38	0.63	74.17	35.05	16.00
4SB7	Socket/Female	3/8	1/4	5/8	Brass	7	2.92	1.38	0.75	74.17	35.05	19.05
4SC7	Socket/Female	3/8	5/16	5/8	Brass	7	2.98	1.38	0.75	75.69	35.05	19.05
4SD7	Socket/Female	3/8	3/8	5/8	Brass	7	3.04	1.38	0.75	77.22	35.05	19.05
4SD9	Socket/Female	3/8	3/8	11/16	Brass	7	3.04	1.38	0.81	77.22	35.05	20.57
4SD11	Socket/Female	3/8	3/8	3/4	Brass	7	3.04	1.38	0.88	77.22	35.05	22.35
4SP13	Socket/Female	3/8	1/2	13/16	Brass	7	3.67	1.38	0.94	93.22	35.05	23.88
4SP15	Socket/Female	3/8	1/2	7/8	Brass	7	3.67	1.38	1.00	93.22	35.05	25.40

Part Number	Coupling Type	Body Size	Hose I.D.	Hose O.D.	Material	Fig.	Dimensions					
							C	D	Hex	C	D	Hex
							(in)	(in)	(in)	(mm)	(mm)	(mm)
4PB3	Plug/Male	3/8	1/4	1/2	Steel	8	2.44	0.70	0.63	61.98	17.78	16.00
4PB7	Plug/Male	3/8	1/4	5/8	Steel	8	2.44	0.84	0.75	61.98	21.34	19.05
4PD7	Plug/Male	3/8	3/8	5/8	Steel	8	2.56	0.84	0.75	65.02	21.34	19.05
4PD9	Plug/Male	3/8	3/8	11/16	Steel	8	2.56	0.91	0.81	65.02	23.11	20.57
4PD11	Plug/Male	3/8	3/8	3/4	Steel	8	2.56	0.98	0.88	65.02	24.89	22.35
4PD15	Plug/Male	3/8	3/8	7/8	Steel	8	2.56	1.12	1.00	65.02	28.45	25.40
4PP13	Plug/Male	3/8	1/2	13/16	Steel	8	3.25	1.05	0.94	82.55	26.67	23.88
4PP15	Plug/Male	3/8	1/2	7/8	Steel	8	3.25	1.12	1.00	82.55	28.45	25.40
4PP19	Plug/Male	3/8	1/2	1	Steel	8	3.25	1.26	1.13	82.55	32.00	28.70
4PB5	Plug/Male	3/8	1/4	9/16	Steel	8	2.44	0.77	0.69	61.98	19.56	17.53

5000 Series

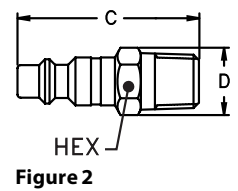
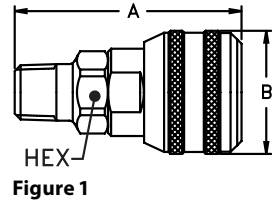

Male End Connections

Part Number	Coupling Type	Body Size	Port Size	Thread	Type	Material	Fig.	Dimensions			Hex	A	B	Hex
								A	B	Hex				
								(in)	(in)	(in)				
50100	Socket/Female	1/2	1/4	1/4-18	NPTF	Brass	1	2.78	1.50	1.00	70.61	38.10	25.40	
5100E	Socket/Female	1/2	3/8	3/8-18	NPTF	Brass	1	2.79	1.50	1.00	70.87	38.10	25.40	
5300E	Socket/Female	1/2	1/2	1/2-14	NPTF	Brass	1	2.98	1.50	1.00	75.69	38.10	25.40	
5500	Socket/Female	1/2	3/4	3/4-14	NPTF	Brass	1	2.98	1.50	1.06	75.69	38.10	26.92	

Part Number	Coupling Type	Body Size	Port Size	Thread	Type	Material	Fig.	Dimensions			Hex	C	D	Hex
								C	D	Hex				
								(in)	(in)	(in)				
50E	Plug/Male	1/2	1/4	1/4-18	NPTF	Steel	2	2.25	0.79	0.69	57.15	20.07	17.53	
50G†	Plug/Male	1/2	1/4	1/4-18	NPTF	Steel	2	2.90	0.98	0.88	73.66	24.89	22.35	
52	Plug/Male	1/2	3/8	3/8-18	NPTF	Steel	2	2.25	0.87	0.75	57.15	22.10	19.05	
52G†	Plug/Male	1/2	3/8	3/8-18	NPTF	Steel	2	2.90	0.98	0.88	73.66	24.89	22.35	
54E	Plug/Male	1/2	1/2	1/2-14	NPTF	Steel	2	2.44	1.01	0.88	61.98	25.65	22.35	
54G†	Plug/Male	1/2	1/2	1/2-14	NPTF	Steel	2	3.09	0.98	0.88	78.49	24.89	22.35	
56	Plug/Male	1/2	3/4	3/4-14	NPTF	Steel	2	2.50	1.23	1.06	63.50	31.24	26.92	
56G†	Plug/Male	1/2	3/4	3/4-14	NPTF	Steel	2	3.14	1.19	1.06	79.76	30.23	26.92	
B52	Plug/Male	1/2	3/8	3/8-18	NPTF	Brass	2	2.25	0.87	0.75	57.15	22.10	19.05	
B54	Plug/Male	1/2	1/2	1/2-14	NPTF	Brass	2	2.44	1.01	0.88	61.98	25.65	22.35	

†With Bleeder Ball Check—Reduces Hose Whip

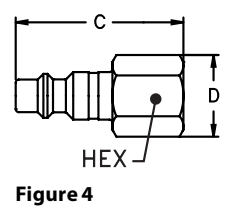
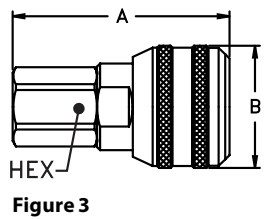

Female End Connections

Part Number	Coupling Type	Body Size	Port Size	Thread	Type	Material	Fig.	Dimensions			Hex	A	B	Hex
								A	B	Hex				
								(in)	(in)	(in)				
5000A	Socket/Female	1/2	1/4	1/4-18	NPTF	Brass	3	2.72	1.50	1.00	69.09	38.10	25.40	
5000	Socket/Female	1/2	3/8	3/8-18	NPTF	Brass	3	2.79	1.50	1.00	70.87	38.10	25.40	
5200	Socket/Female	1/2	1/2	1/2-14	NPTF	Brass	3	3.07	1.50	1.00	77.98	38.10	25.40	
5400E	Socket/Female	1/2	3/4	3/4-14	NPTF	Brass	3	3.10	1.50	1.19	78.74	38.10	30.23	

Part Number	Coupling Type	Body Size	Port Size	Thread	Type	Material	Fig.	Dimensions			Hex	C	D	Hex
								C	D	Hex				
								(in)	(in)	(in)				
53A	Plug/Male	1/2	1/4	1/4-18	NPTF	Steel	4	1.92	0.79	0.69	48.77	20.07	17.53	
53	Plug/Male	1/2	3/8	3/8-18	NPTF	Steel	4	2.06	0.94	0.81	52.32	23.88	20.57	
53G†	Plug/Male	1/2	3/8	3/8-18	NPTF	Steel	4	2.9	0.98	0.88	73.66	24.89	22.35	
55	Plug/Male	1/2	1/2	1/2-14	NPTF	Steel	4	2.34	1.15	1	59.44	29.21	25.40	
55G†	Plug/Male	1/2	1/2	1/2-14	NPTF	Steel	4	3.17	1.15	1.00	80.52	29.21	25.40	
57	Plug/Male	1/2	3/4	3/4-14	NPTF	Steel	4	2.44	1.37	1.19	61.98	34.80	30.23	

†With Bleeder Ball Check—Reduces Hose Whip

5000 Series

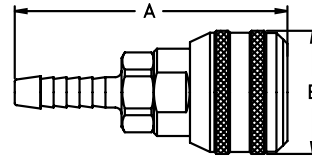

Figure 5

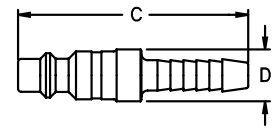

Figure 6

Hose Stem End Connections

Part Number	Coupling Type	Body Size	Hose I.D.	Material	Fig.	Dimensions			
						A (in)	B (in)	A (mm)	B (mm)
50400	Socket/Female	1/2	1/4	Brass	5	3.29	1.50	83.57	38.10
5700E	Socket/Female	1/2	3/8	Brass	5	3.33	1.50	84.58	38.10
5800E	Socket/Female	1/2	1/2	Brass	5	3.25	1.50	82.55	38.10
5900	Socket/Female	1/2	3/4	Brass	5	4.10	1.50	104.14	38.10
Part Number	Coupling Type	Body Size	Hose I.D.	Material	Fig.	Dimensions			
						C (in)	D (in)	C (mm)	D (mm)
585	Plug/Male	1/2	5/16	Steel	6	2.66	0.69	67.56	17.53
585G†	Plug/Male	1/2	5/16	Brass	6	3.37	0.98	85.60	24.89
59	Plug/Male	1/2	3/8	Steel	6	2.66	0.69	67.56	17.53
59G†	Plug/Male	1/2	3/8	Brass	6	3.37	0.98	85.60	24.89
60	Plug/Male	1/2	1/2	Steel	6	2.66	0.75	67.56	19.05
60G†	Plug/Male	1/2	1/2	Brass	6	3.37	0.98	85.60	24.89
61E	Plug/Male	1/2	3/4	Steel	6	3.50	1.00	88.90	25.40
61G†	Plug/Male	1/2	3/4	Brass	6	4.22	0.98	107.19	24.89
B60	Plug/Male	1/2	1/2	Brass	6	2.75	0.88	69.85	22.35

†With Bleeder Ball Check—Reduces Hose Whip

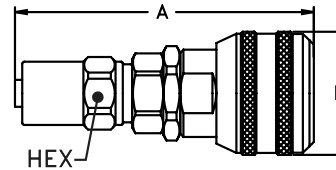

Figure 7

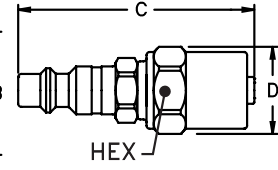

Figure 8

Hose Clamp End Connections

Part Number	Coupling Type	Body Size	Hose I.D.	Hose O.D.	Material	Fig.	Dimensions					
							A (in)	B (in)	Hex (in)	A (mm)	B (mm)	Hex (mm)
5SD5	Socket/Female	1/2	3/8	9/16	Brass	7	3.50	1.50	0.69	88.90	38.10	17.53
5SD7	Socket/Female	1/2	3/8	5/8	Brass	7	3.50	1.50	0.75	88.90	38.10	19.05
5SD9	Socket/Female	1/2	3/8	11/16	Brass	7	3.50	1.50	0.81	88.90	38.10	20.57
5SD11	Socket/Female	1/2	3/8	3/4	Brass	7	3.50	1.50	0.88	88.90	38.10	22.35
5SP13	Socket/Female	1/2	1/2	13/16	Brass	7	4.10	1.50	0.94	104.14	38.10	23.88
5SP15	Socket/Female	1/2	1/2	7/8	Brass	7	4.10	1.50	1.00	104.14	38.10	25.40
5SR23	Socket/Female	1/2	3/4	1 1/8	Brass	7	4.23	1.50	1.25	107.44	38.10	31.75
5SR25	Socket/Female	1/2	3/4	1 3/16	Brass	7	4.23	1.50	1.31	107.44	38.10	33.27
5SR27	Socket/Female	1/2	3/4	1 1/4	Brass	7	4.23	1.54	1.38	107.44	39.12	35.05
Part Number	Coupling Type	Body Size	Hose I.D.	Hose O.D.	Material	Fig.	Dimensions					
							C (in)	D (in)	Hex (in)	C (mm)	D (mm)	Hex (mm)
5PB3	Plug/Male	1/2	1/4	1/2	Steel	8	2.81	0.70	0.63	71.37	17.78	16.00
5PB5	Plug/Male	1/2	1/4	9/16	Steel	8	2.81	0.77	0.69	71.37	19.56	17.53
5PB7	Plug/Male	1/2	1/4	5/8	Steel	8	2.81	0.84	0.75	71.37	21.34	19.05
5PD5	Plug/Male	1/2	3/8	9/16	Steel	8	2.94	0.77	0.69	74.68	19.56	17.53
5PD7	Plug/Male	1/2	3/8	5/8	Steel	8	2.94	0.84	0.75	74.68	21.34	19.05
5PD9	Plug/Male	1/2	3/8	11/16	Steel	8	2.94	0.91	0.81	74.68	23.11	20.57
5PD11	Plug/Male	1/2	3/8	3/4	Steel	8	2.94	0.98	0.88	74.68	24.89	22.35
5PD13	Plug/Male	1/2	3/8	13/16	Steel	8	2.94	1.05	0.94	74.68	26.67	23.88
5PP13	Plug/Male	1/2	1/2	13/16	Steel	8	3.62	1.05	0.94	91.95	26.67	23.88
5PP15	Plug/Male	1/2	1/2	7/8	Steel	8	3.62	1.12	1.00	91.95	28.45	25.40
5PR23	Plug/Male	1/2	3/4	1 1/8	Steel	8	3.75	1.40	1.25	95.25	35.56	31.75
5PR25	Plug/Male	1/2	3/4	1 3/16	Steel	8	3.75	1.47	1.31	95.25	37.34	33.27
5PR27	Plug/Male	1/2	3/4	1 1/4	Steel	8	3.75	1.54	1.38	95.25	39.12	35.05

6000 Series

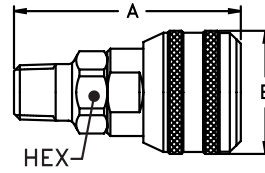

Figure 1

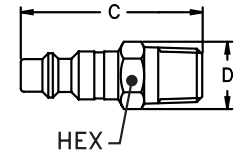

Figure 2

Male End Connections

Part Number	Coupling Type	Body Size	Port Size	Thread	Type	Material	Fig.	Dimensions			Hex	A (mm)	B (mm)	Hex (mm)
								A (in)	B (in)	Hex (in)				
6300	Socket/Female	3/4	1/2	1/2-14	NPTF	Brass	1	2.94	1.90	1.31	74.68	48.26	33.27	
6500	Socket/Female	3/4	3/4	3/4-14	NPTF	Brass	1	2.94	1.90	1.31	74.68	48.26	33.27	
6700E	Socket/Female	3/4	1	1-11 1/2	NPTF	Brass	1	3.13	1.90	1.31	79.50	48.26	33.27	
Part Number	Coupling Type	Body Size	Port Size	Thread	Type	Material	Fig.	Dimensions			Hex	C (mm)	D (mm)	Hex (mm)
								C (in)	D (in)	Hex (in)				
64A	Plug/Male	3/4	1/2	1/2-14	NPTF	Steel	2	2.31	1.15	1.00	58.67	29.21	25.40	
64GA†	Plug/Male	3/4	1/2	1/2-14	NPTF	Steel	2	3.26	1.12	1.00	82.80	28.45	25.40	
66AE	Plug/Male	3/4	3/4	3/4-14	NPTF	Steel	2	2.38	1.23	1.06	60.45	31.24	26.92	
66GA†	Plug/Male	3/4	3/4	3/4-14	NPTF	Steel	2	3.26	1.19	1.06	82.80	30.23	26.92	
68A	Plug/Male	3/4	1	1-11 1/2	NPTF	Steel	2	2.56	1.51	1.31	65.02	38.35	33.27	
B64A	Plug/Male	3/4	1/2	1/2-14	NPTF	Brass	2	2.31	1.12	1.00	58.67	28.45	25.40	
B66A	Plug/Male	3/4	3/4	3/4-14	NPTF	Brass	2	2.38	1.18	1.06	60.45	30.07	26.92	

†With Bleeder Ball Check—Reduces Hose Whip

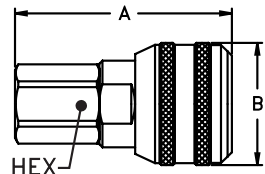

Figure 3

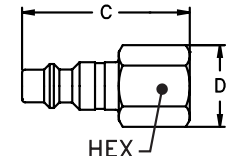

Figure 4

Female End Connections

Part Number	Coupling Type	Body Size	Port Size	Thread	Type	Material	Fig.	Dimensions			Hex	A (mm)	B (mm)	Hex (mm)
								A (in)	B (in)	Hex (in)				
6200E	Socket/Female	3/4	1/2	1/2-14	NPTF	Brass	3	2.85	1.90	1.31	72.39	48.26	33.27	
6400E	Socket/Female	3/4	3/4	3/4-14	NPTF	Brass	3	3.00	1.90	1.31	76.20	48.26	33.27	
6600E	Socket/Female	3/4	1	1-11 1/2	NPTF	Brass	3	3.19	1.90	1.56	81.03	48.26	39.62	
Part Number	Coupling Type	Body Size	Port Size	Thread	Type	Material	Fig.	Dimensions			Hex	C (mm)	D (mm)	Hex (mm)
								C (in)	D (in)	Hex (in)				
65A	Plug/Male	3/4	1/2	1/2-14	NPTF	Steel	4	2.22	1.15	1.00	56.39	29.21	25.40	
65GAS†	Plug/Male	3/4	1/2	1/2-14	NPTF	Steel	4	3.35	1.12	1.00	85.09	28.45	25.40	
67A	Plug/Male	3/4	3/4	3/4-14	NPTF	Steel	4	2.22	1.33	1.19	56.39	33.78	30.23	
67GAS†	Plug/Male	3/4	3/4	3/4-14	NPTF	Steel	4	3.38	1.33	1.19	85.85	33.78	30.23	
69A	Plug/Male	3/4	1	1-11 1/2	NPTF	Steel	4	2.41	1.80	1.56	61.21	45.72	39.62	

†With Bleeder Ball Check—Reduces Hose Whip

6000 Series

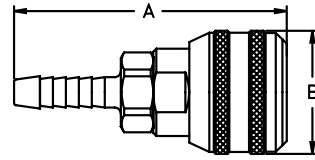

Figure 5

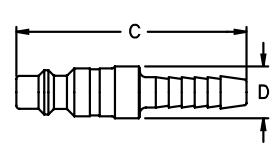

Figure 6

Hose Stem End Connections

Part Number	Coupling Type	Body Size	Hose I.D.	Material	Fig.	Dimensions		A (mm)	B (mm)
						A (in)	B (in)		
6800E	Socket/Female	3/4	1/2	Brass	5	3.21	1.88	81.53	47.75
6900	Socket/Female	3/4	3/4	Brass	5	4.06	1.88	103.12	47.75
7000E	Socket/Female	3/4	1	Brass	5	4.07	1.88	103.38	47.75

Part Number	Coupling Type	Body Size	Hose I.D.	Material	Fig.	Dimensions		C (mm)	D (mm)
						C (in)	D (in)		
70A	Plug/Male	3/4	1/2	Steel	6	2.53	0.94	64.26	23.88
70GA†	Plug/Male	3/4	1/2	Steel	6	3.53	1.12	89.66	28.45
71A	Plug/Male	3/4	3/4	Steel	6	3.44	1.06	87.38	26.92
71GA†	Plug/Male	3/4	3/4	Steel	6	4.38	1.12	111.25	28.45
72A	Plug/Male	3/4	1	Steel	6	3.44	1.31	87.38	33.27
B71A	Plug/Male	3/4	3/4	Steel	6	3.44	1.06	87.38	26.92

†With Bleeder Ball Check—Reduces Hose Whip

Dust Caps and Dust Plugs

Series	Dust Cap		Dust Plug	
	Metal	Vinyl	Metal	Vinyl
3000	XPDC3000*	—	SDC3000*	XPSDC1HK
4000	—	—	—	XPSDC2HK
5000	—	XPPDC2HK	—	—
6000	—	XPPDC3HK	—	—

*Brass



Auto-Flo 23/24 Series

Pneumatic application



Danfoss' Auto-Flo 23/24 Series of pneumatic couplings were designed with high flow and easy automatic connection for compressed air in mind. The universal design makes the Auto-Flo an extremely flexible coupling series.

Product Features

- Auto-Flo 23 is the first automatic universal quick disconnect coupling designed to operate with Industrial, ARO 210 and Tru-Flate Interchange plugs/males
- Auto-Flo 24 operates with CEJN 320 and Rectus 25 Interchange plugs/males
- Easy, automatic, push-to-connect design provides instantaneous connection and disconnection of lines, plus automatic shut-off of socket/female end of line
- Sleeve guard protects against accidental disconnection
- Standard body material: Brass
- Standard seal material: Buna-N

Physical Characteristics

Series	Max. Operating Pressure		Min. Burst Pressure		Rated Flow	
	(bar)	(psi)	(bar)	(psi)	(lpm)	scfm
Auto-Flo 23	10	150	40	600	792	28
Auto-Flo 24	10	150	40	600	1,274	45

Applications & Markets

- General Pneumatics
- Air Tools
- Construction

Interchangeability

Auto-Flo 23	Auto-Flo 24
US Industrial Interchange	(Euro Interchange)
ISO 6150 Series B	
A-A-59439 (former MIL-C-4109)	CEJN 320
Tru-Flate Interchange	
ARO 210 Interchange	RECTUS 25

Flow Data

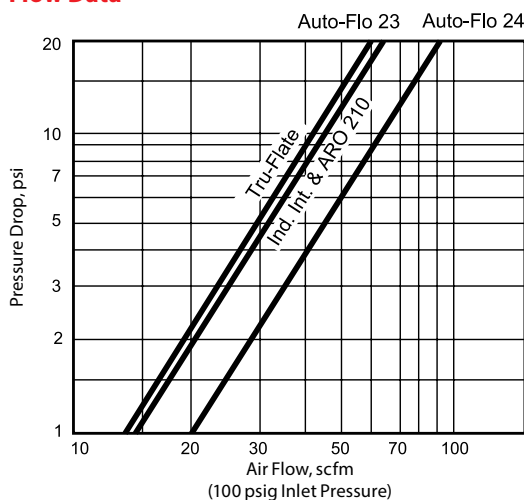

Auto-Flo 23 Series

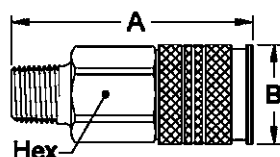

Figure 1

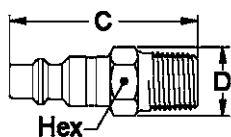

Figure 2

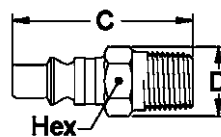

Figure 3 (ARO 210)

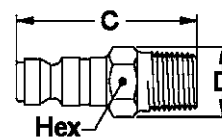

Figure 4 (Tru-Flate)

Male End Connections

Part Number	Coupling Type	Body Size	Port Size	Thread	Type	Material	Fig.	Dimensions			A	B	Hex
								A	B	Hex			
								(in)	(in)	(in)	(mm)	(mm)	(mm)
B23AS25M	Socket/Female	1/4	1/4	1/4-18	NPTF	Brass	1	2.23	0.96	0.81	56.64	24.38	20.57
B23AS25MBST	Socket/Female	1/4	1/4	1/4-19	BSPT	Brass	1	2.23	0.96	0.81	56.64	24.38	20.57
B23AS37M	Socket/Female	1/4	3/8	3/8-18	NPTF	Brass	1	2.23	0.96	0.81	56.64	24.38	20.57
B23AS37MBST	Socket/Female	1/4	3/8	3/8-19	BSPT	Brass	1	2.23	0.96	0.81	56.64	24.38	20.57
B23AS50MBST	Socket/Female	1/4	1/2	1/2-14	BSPT	Brass	1	2.23	0.96	0.88	56.64	24.38	22.35
Part Number	Coupling Type	Body Size	Port Size	Thread	Type	Material	Fig.	Dimensions			C	D	Hex
								C	D	Hex			
								(in)	(in)	(in)	(mm)	(mm)	(mm)
10	Plug/Male	1/4	1/4	1/4-18	NPTF	Steel	2	1.75	0.62	0.56	44.45	15.75	14.22
10CS	Plug/Male	1/4	1/4	1/4-18	NPTF	Steel	2	1.75	0.65	0.56	44.45	16.51	14.22
10G†	Plug/Male	1/4	1/4	1/4-18	NPTF	Steel	2	1.75	0.65	0.56	44.45	16.51	14.22
12E	Plug/Male	1/4	1/8	1/8-27	NPTF	Steel	2	1.59	0.58	0.5	40.39	14.73	12.70
12G†	Plug/Male	1/4	1/8	1/8-27	NPTF	Steel	2	2.38	0.77	0.69	60.45	19.56	17.53
14	Plug/Male	1/4	3/8	3/8-18	NPTF	Steel	2	1.75	0.79	0.69	44.45	20.07	17.53
14G†	Plug/Male	1/4	3/8	3/8-18	NPTF	Steel	2	2.53	0.77	0.69	64.26	19.56	17.53
B10	Plug/Male	1/4	1/4	1/4-18	NPTF	Brass	2	1.75	0.62	0.56	44.45	15.75	14.22
LL10	Plug/Male	1/4	1/4	1/4-18	NPTF	Stainless	2	1.75	0.62	0.56	44.45	15.75	14.22
2607	Plug/Male	1/4	1/8	1/8-27	NPTF	Steel	3	1.42	0.58	0.5	36.07	14.73	12.70
2608	Plug/Male	1/4	1/4	1/4-18	NPTF	Steel	3	1.68	0.65	0.56	42.67	16.51	14.22
2608B	Plug/Male	1/4	1/4	1/4-19	BSPT	Steel	3	1.68	0.65	0.56	42.67	16.51	14.22
20AP37M	Plug/Male	1/4	3/8	3/8-18	NPTF	Steel	3	1.68	0.79	0.69	42.67	20.07	17.53
21AP25M	Plug/Male	1/4	1/4	1/4-18	NPTF	Steel	4	1.65	0.65	0.56	41.91	16.51	14.22
10NK*	Plug/Male	1/4	1/4	1/4-18	NPTF	Steel	2	1.75	0.62	0.56	44.45	15.75	14.22

S With Ball Check † With Bleeder Ball Check—Reduces Hose Whip * Nickel plated

Auto-Flo 23 Series

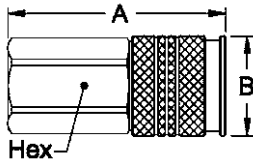

Figure 1

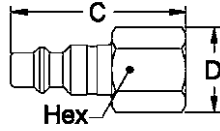

Figure 2

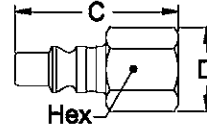

Figure 3 (ARO 210)

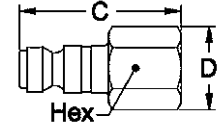

Figure 4 (Tru-Flate)

Female End Connections

Part Number	Coupling Type	Body Size	Port Size	Thread	Type	Material	Fig.	Dimensions			A	B	Hex
								A	B	Hex			
								(in)	(in)	(in)	(mm)	(mm)	(mm)
B23AS25F	Socket/Female	1/4	1/4	1/4-18	NPTF	Brass	1	2.02	0.96	0.81	51.31	24.38	20.57
B23AS25FBS	Socket/Female	1/4	1/4	1/4-19	BSPP	Brass	1	2.02	0.96	0.81	51.31	24.38	20.57
B23AS37F	Socket/Female	1/4	3/8	3/8-18	NPTF	Brass	1	2.02	0.96	0.81	51.31	24.38	20.57
B23AS37FBS	Socket/Female	1/4	3/8	3/8-19	BSPP	Brass	1	2.02	0.96	0.81	51.31	24.38	20.57
Part Number	Coupling Type	Body Size	Port Size	Thread	Type	Material	Fig.	Dimensions			C	D	Hex
								C	D	Hex			
								(in)	(in)	(in)	(mm)	(mm)	(mm)
11	Plug/Male	1/4	1/4	1/4-18	NPTF	Steel	2	1.63	0.79	0.69	41.40	20.07	17.53
11G†	Plug/Male	1/4	1/4	1/4-18	NPTF	Steel	2	2.44	0.77	0.69	61.98	19.56	17.53
13	Plug/Male	1/4	1/8	1/8-27	NPTF	Steel	2	1.47	0.65	0.56	37.34	16.51	14.22
15E	Plug/Male	1/4	3/8	3/8-18	NPTF	Steel	2	1.69	0.94	0.81	42.93	23.88	20.57
11B	Plug/Male	1/4	1/4	1/4-18	NPTF	Brass	2	1.63	0.79	0.69	41.40	20.07	17.53
LL11	Plug/Male	1/4	1/4	1/4-18	NPTF	Stainless	2	1.63	0.79	0.69	41.40	20.07	17.53
2609	Plug/Male	1/4	1/4	1/4-18	NPTF	Steel	3	1.55	0.79	0.69	39.37	20.07	17.53
2609B	Plug/Male	1/4	1/4	1/4-19	BSPP	Steel	3	1.52	0.79	0.69	38.61	20.07	17.53
20AP37F	Plug/Male	1/4	3/8	3/8-18	NPTF	Steel	3	1.61	0.94	0.81	40.89	23.88	20.57
21AP25F	Plug/Male	1/4	1/4	1/4-18	NPTF	Steel	4	1.53	0.79	0.69	38.86	20.07	17.53
11NK*	Plug/Male	1/4	1/4	1/4-18	NPTF	Steel	2	1.63	0.79	0.69	41.40	20.07	17.53

†With Bleeder Ball Check—Reduces Hose Whip *Nickel plated

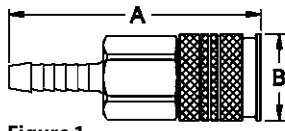

Figure 1

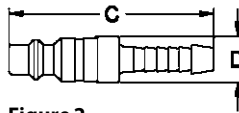

Figure 2



Figure 3 (ARO 210)

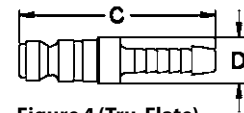

Figure 4 (Tru-Flate)

Hose Stem End Connections

Part Number	Coupling Type	Body Size	Hose I.D.	Material	Fig.	Dimensions		A	B
						A	B		
						(in)	(in)	(mm)	(mm)
B23AS25H	Socket/Female	1/4	1/4	Brass	1	2.76	0.96	70.10	24.38
B23AS31H	Socket/Female	1/4	5/16	Brass	1	2.73	0.96	69.34	24.38
B23AS37H	Socket/Female	1/4	3/8	Brass	1	2.73	0.96	69.34	24.38
B23AS50H	Socket/Female	1/4	1/2	Brass	1	2.7	0.96	68.58	24.38
Part Number	Coupling Type	Body Size	Hose I.D.	Material	Fig.	Dimensions		C	D
						C	D		
						(in)	(in)	(mm)	(mm)
16	Plug/Male	1/4	1/4	Steel	2	2.22	0.5	56.39	12.70
16G†	Plug/Male	1/4	1/4	Steel	2	2.97	0.77	75.44	19.56
16P‡	Plug/Male	1/4	1/4	Steel	2	2.00	0.58	50.80	14.73
17	Plug/Male	1/4	3/8	Steel	2	2.22	0.5	56.39	12.70
17G†	Plug/Male	1/4	3/8	Steel	2	2.96	0.77	75.18	19.56
17P‡	Plug/Male	1/4	3/8	Steel	2	2.06	0.5	52.32	12.70
18E	Plug/Male	1/4	5/16	Steel	2	2.22	0.5	56.39	12.70
B17	Plug/Male	1/4	3/8	Brass	2	2.22	0.5	56.39	12.70
3946	Plug/Male	1/4	1/4	Steel	3	2.14	0.5	54.36	12.70
3947	Plug/Male	1/4	5/16	Steel	3	2.14	0.5	54.36	12.70
22238E	Plug/Male	1/4	3/8	Steel	3	2.14	0.5	54.36	12.70
21AP25H	Plug/Male	1/4	1/4	Steel	4	2.12	0.5	53.85	12.70
16NK*	Plug/Male	1/4	1/4	Steel	2	2.22	0.5	56.39	12.70
17NK*	Plug/Male	1/4	3/8	Steel	2	2.22	0.5	56.39	12.70

†With Bleeder Ball Check—Reduces Hose Whip ‡For use with push-on style hose *Nickel plated

Auto-Flo 24 Series

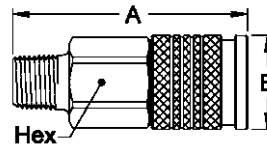

Figure 1

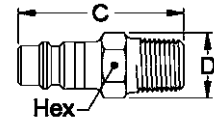

Figure 2

Male End Connections

Part Number	Coupling Type	Body Size	Port Size	Thread	Type	Material	Fig.	Dimensions			Hex	A	B	Hex	
								A	B	Hex					
								(in)	(in)	(in)	(mm)	(mm)	(mm)		
B24AS25M	Socket/Female	1/4	1/4	1/4-18	NPTF	Brass	1	2.27	0.96	0.81	57.66	24.38	20.57		
Part Number	Coupling Type	Body Size	Port Size	Thread	Type	Material	Fig.	Dimensions			Hex	C	D	Hex	
								C	D	Hex					
								(in)	(in)	(in)	(mm)	(mm)	(mm)		
24AP25MBST	Plug/Male	1/4	1/4	1/4-19	BSPT	Steel	2	1.62	0.65	0.56	41.15	16.51	14.22		
24AP50MBST	Plug/Male	1/4	1/2	1/2-14	BSPT	Steel	2	1.88	1.01	0.88	47.75	25.65	22.35		

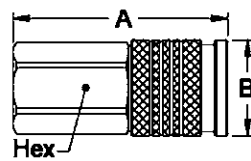

Figure 1

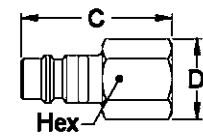

Figure 2

Female End Connections

Part Number	Coupling Type	Body Size	Port Size	Thread	Type	Material	Fig.	Dimensions			Hex	A	B	Hex	
								A	B	Hex					
								(in)	(in)	(in)	(mm)	(mm)	(mm)		
B24AS25F	Socket/Female	1/4	1/4	1/4-18	NPTF	Brass	1	2.06	0.96	0.81	52.32	24.38	20.57		
B24AS25FBS	Socket/Female	1/4	1/4	1/4-19	BSPP	Brass	1	2.06	0.96	0.81	52.32	24.38	20.57		
B24AS37FBS	Socket/Female	1/4	3/8	3/8-19	BSPP	Brass	1	2.06	0.96	0.81	52.32	24.38	20.57		
B24AS50FBS	Socket/Female	1/4	1/2	1/2-14	BSPP	Brass	1	2.38	0.96	1.06	60.45	24.38	26.92		
Part Number	Coupling Type	Body Size	Port Size	Thread	Type	Material	Fig.	Dimensions			Hex	C	D	Hex	
								C	D	Hex					
								(in)	(in)	(in)	(mm)	(mm)	(mm)		
24AP25FG	Plug/Male	1/4	1/4	1/4-18	NPTF	Steel	2	1.49	0.79	0.69	37.85	20.07	17.53		
24AP25FBS	Plug/Male	1/4	1/4	1/4-19	BSPP	Steel	2	1.46	0.79	0.69	37.08	20.07	17.53		

210/310 Series

Pneumatic application

Danfoss' 210/310 series pneumatic couplings have a pin-type one-way shut off operation.



Product Features

- Automatic push-to-connect
- Pin-lock design
- Alloy steel locking pins
- Standard body material: Zinc trivalent plated carbon steel
- Standard seal material: Buna-N

Physical Characteristics

Series	Body Size	Max. Operating Pressure		Min. Burst Pressure		Rated Flow	
	(in)	(bar)	(psi)	(bar)	(psi)	(lpm)	scfm
210	1/4	17	250	68	1,000	538	19
310	3/8	17	250	68	1,000	1,415	50

Applications & Markets

- Construction
- Maintenance and Repair
- In-plant/Industrial
- Pneumatic Tools

Flow Data

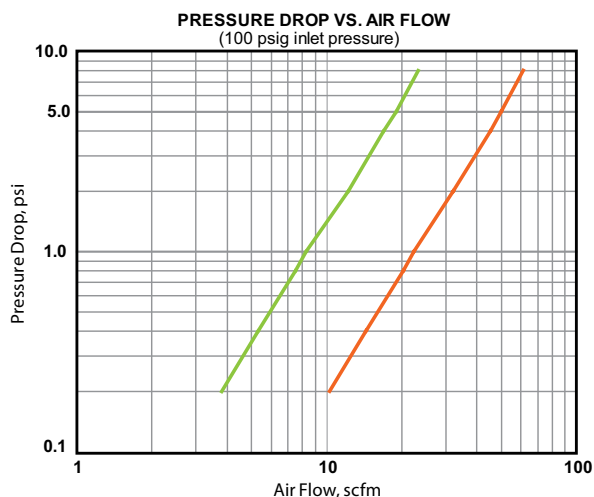

210 Series

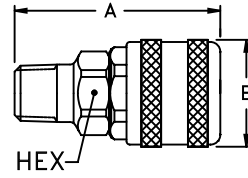

Figure 1

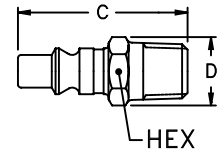

Figure 2

Male End Connections

Part Number	Coupling Type	Body Size	Port Size	Thread	Type	Fig.	Dimensions			A	B	Hex
							A	B	Hex			
							(in)	(in)	(in)	(mm)	(mm)	(mm)
210212	Socket/Female	1/4	1/4	1/4-18	NPTF	1	1.95	1.02	0.69	49.5	25.9	17.5
210213	Socket/Female	1/4	3/8	3/8-18	NPTF	1	1.91	1.02	0.69	48.5	25.9	17.5

Part Number	Coupling Type	Body Size	Port Size	Thread	Type	Fig.	Dimensions			C	D	Hex
							C	D	Hex			
							(in)	(in)	(in)	(mm)	(mm)	(mm)
2607	Plug/Male	1/4	1/8	1/8-27	NPTF	2	1.42	0.58	0.5	36.1	14.7	12.7
2608	Plug/Male	1/4	1/4	1/4-18	NPTF	2	1.68	0.65	0.56	42.7	16.5	14.2
2608B	Plug/Male	1/4	1/4	1/4-19	BSPT	2	1.68	0.65	0.56	42.7	16.5	14.2
20AP37M	Plug/Male	1/4	3/8	3/8-18	NPTF	2	1.68	0.79	0.69	42.7	20.1	17.5

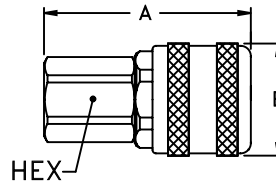

Figure 1

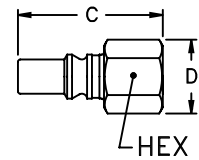

Figure 2

Female End Connections

Part Number	Coupling Type	Body Size	Port Size	Thread	Type	Fig.	Dimensions			A	B	Hex
							A	B	Hex			
							(in)	(in)	(in)	(mm)	(mm)	(mm)
210	Socket/Female	1/4	1/4	1/4-18	NPTF	1	1.87	1.02	0.69	47.5	25.9	17.5
62210*	Socket/Female	1/4	1/4	1/4-18	NPTF	1	1.87	1.02	0.69	47.5	25.9	17.5
210B	Socket/Female	1/4	1/4	1/4-19	BSPP	1	1.64	1.02	0.75	41.7	25.9	19.1

Part Number	Coupling Type	Body Size	Port Size	Thread	Type	Fig.	Dimensions			C	D	Hex
							C	D	Hex			
							(in)	(in)	(in)	(mm)	(mm)	(mm)
2609	Plug/Male	1/4	1/4	1/4-18	NPTF	2	1.55	0.79	0.69	39.4	20.1	17.5
2609B	Plug/Male	1/4	1/4	1/4-19	BSPP	2	1.52	0.79	0.69	38.6	20.1	17.5
20AP37F	Plug/Male	1/4	3/8	3/8-18	NPTF	2	1.61	0.94	0.81	40.9	23.9	20.6

*Same as Model 210 but with brass valve.

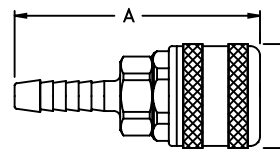

Figure 1

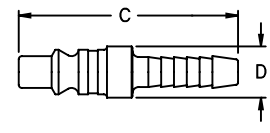

Figure 2

Hose Stem End Connections

Part Number	Coupling Type	Body Size	Hose I.D.	Fig.	Dimensions		A	B
					A	B		
					(in)	(in)	(mm)	(mm)
210022	Socket/Female	1/4	1/4	1	2.39	1.02	60.7	25.9
210215	Socket/Female	1/4	3/8	1	2.39	1.02	60.7	25.9

Part Number	Coupling Type	Body Size	Hose I.D.	Fig.	Dimensions		C	D
					C	D		
					(in)	(in)	(mm)	(mm)
3946	Plug/Male	1/4	1/4	2	2.14	0.47	54.4	11.9
3947	Plug/Male	1/4	5/16	2	2.14	0.47	54.4	11.9
22238E	Plug/Male	1/4	3/8	2	2.14	0.5	54.4	12.7

310 Series

Pneumatic application

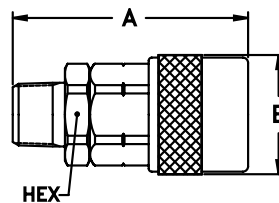

Figure 1

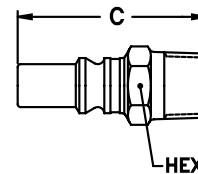

Figure 2

Male End Connections

Part Number	Coupling Type	Body Size	Port Size	Thread	Type	Fig.	Dimensions			A	B	Hex
							A	B	Hex			
							(in)	(in)	(in)	(mm)	(mm)	(mm)
310313	Socket/Female	3/8	3/8	3/8-18	NPTF	1	2.37	1.21	0.94	60.2	30.7	23.9
Part Number	Coupling Type	Body Size	Port Size	Thread	Type	Fig.	Dimensions			C	D	Hex
							C	D	Hex			
							(in)	(in)	(in)	(mm)	(mm)	(mm)
22239E	Plug/Male	3/8	1/4	1/4-18	NPTF	2	1.91	0.72	0.63	48.5	18.3	16.0
3804	Plug/Male	3/8	3/8	3/8-18	NPTF	2	1.91	0.79	0.69	48.5	20.1	17.5

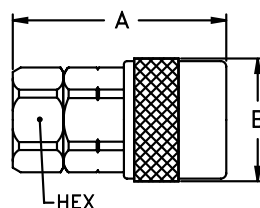

Figure 1

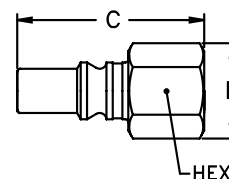

Figure 2

Female End Connections

Part Number	Coupling Type	Body Size	Port Size	Thread	Type	Fig.	Dimensions			A	B	Hex
							A	B	Hex			
							(in)	(in)	(in)	(mm)	(mm)	(mm)
310	Socket/Female	3/8	3/8	3/8-18	NPTF	1	2.1	1.21	0.94	53.3	30.7	23.9
Part Number	Coupling Type	Body Size	Port Size	Thread	Type	Fig.	Dimensions			C	D	Hex
							C	D	Hex			
							(in)	(in)	(in)	(mm)	(mm)	(mm)
3806	Plug/Male	3/8	3/8	3/8-18	NPTF	2	1.84	0.94	0.81	46.7	23.9	20.6

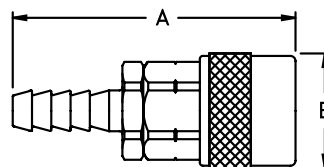

Figure 1

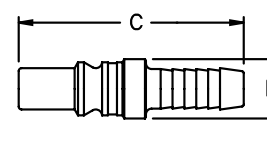

Figure 2

Hose Stem End Connections

Part Number	Coupling Type	Body Size	Hose I.D.	Fig.	Dimensions		A	B
					A	B		
					(in)	(in)	(mm)	(mm)
310222	Socket/Female	3/8	3/8	1	2.97	1.21	75.4	30.7
Part Number	Coupling Type	Body Size	Hose I.D.	Fig.	Dimensions		C	D
					C	D		
					(in)	(in)	(mm)	(mm)
3807	Plug/Male	3/8	3/8	2	2.37	0.59	60.2	15.0

100 Series

Pneumatic application



Danfoss' 100 Series quick disconnect couplings are designed to prevent the crossing of lines. These couplings are used for compressed air and gases.

Product Features

- Non-interchangeable design prevents crossing of lines
- Standard body material: Brass
- Standard seal material: Buna-N

Physical Characteristics

Series	Body Size	Max. Operating Pressure		Min. Burst Pressure		Rated Flow	
	(in)	(bar)	(psi)	(bar)	(psi)	(lpm)	scfm
100	1/4	24	350	96	2,800	566	20

Applications & Markets

- General Pneumatics
- Industrial Plants

Flow Data

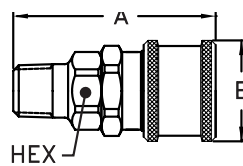
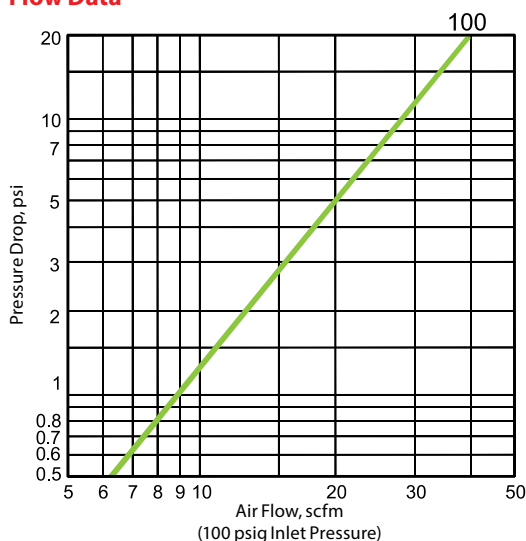

Figure 1

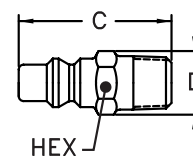

Figure 2

Male End Connections

Part Number	Coupling Type	Body Size	Port Size	Thread	Type	Fig.	Dimensions			A	B	Hex
							A	B	Hex			
							(in)	(in)	(in)	(mm)	(mm)	(mm)
101	Socket/Female	1/4	1/8	1/8-27	NPTF	1	1.86	1.03	0.69	47.2	26.2	17.5
103	Socket/Female	1/4	1/4	1/4-18	NPTF	1	2.05	1.03	0.69	52.1	26.2	17.5
105	Socket/Female	1/4	3/8	3/8-18	NPTF	1	2.01	1.03	0.69	51.1	26.2	17.5
Part Number	Coupling Type	Body Size	Port Size	Thread	Type	Fig.	Dimensions			C	D	Hex
							C	D	Hex			
							(in)	(in)	(in)	(mm)	(mm)	(mm)
1G1	Plug/Male	1/4	1/8	1/8-27	NPTF	2	1.38	0.65	0.56	35.1	16.5	14.2
1G3E	Plug/Male	1/4	1/4	1/4-18	NPTF	2	1.56	0.65	0.56	39.6	16.5	14.2
1G5E	Plug/Male	1/4	3/8	3/8-18	NPTF	2	1.56	0.79	0.69	39.6	20.1	17.5

100 Series

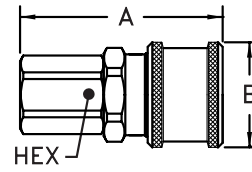

Figure 1

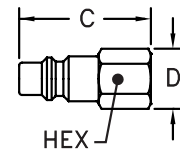

Figure 2

Female End Connections

Part Number	Coupling Type	Body Size	Port Size	Thread	Type	Fig.	Dimensions			A	B	Hex
							A	B	Hex			
							(in)	(in)	(in)	(mm)	(mm)	(mm)
100E	Socket/Female	1/4	1/8	1/8-27	NPTF	1	1.75	1.03	0.69	44.5	26.2	17.5
102E	Socket/Female	1/4	1/4	1/4-18	NPTF	1	1.97	1.03	0.69	50.0	26.2	17.5
104	Socket/Female	1/4	3/8	3/8-18	NPTF	1	2.05	1.03	0.75	52.1	26.2	19.1

Part Number	Coupling Type	Body Size	Port Size	Thread	Type	Fig.	Dimensions			C	D	Hex
							C	D	Hex			
							(in)	(in)	(in)	(mm)	(mm)	(mm)
1G2	Plug/Male	1/4	1/4	1/4-18	NPTF	2	1.43	0.79	0.69	36.3	20.1	17.5

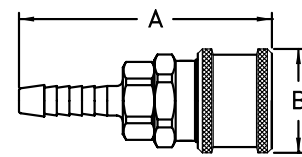

Figure 1

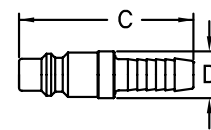

Figure 2

Hose Stem End Connections

Part Number	Coupling Type	Body Size	Hose I.D.	Fig.	Dimensions		A	B
					A	B		
					(in)	(in)	(mm)	(mm)
110E	Socket/Female	1/4	1/4	1	2.49	1.03	63.2	26.2
111E	Socket/Female	1/4	5/16	1	2.49	1.03	63.2	26.2
112E	Socket/Female	1/4	3/8	1	2.49	1.03	63.2	26.2

Part Number	Coupling Type	Body Size	Hose I.D.	Fig.	Dimensions		C	D
					C	D		
					(in)	(in)	(mm)	(mm)
1G10E	Plug/Male	1/4	1/4	2	2.00	0.56	50.8	14.2
1G12E	Plug/Male	1/4	3/8	2	2.03	0.56	51.6	14.2

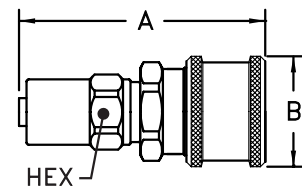

Figure 1

Hose Clamp End Connections

Part Number	Coupling Type	Body Size	Hose I.D.	Hose O.D.	Fig.	Dimensions			A	B	Hex	
						A	B	Hex				
							(in)	(in)	(in)	(mm)	(mm)	(mm)
1GB3	Socket/Female	1/4	1/4	1/2	1	2.58	1.03	0.63	65.5	26.2	16.0	
1GB7	Socket/Female	1/4	1/4	5/8	1	2.58	1.03	0.75	65.5	26.2	19.1	
1GD9	Socket/Female	1/4	3/8	11/16	1	2.70	1.03	0.81	68.6	26.2	20.6	

Dust Caps and Dust Plugs

Series	Dust Cap	Dust Plug
100	XPPDC1HK	XPSPDC1HK



180/280 Series

Pneumatic application

Danfoss' 180/280 series miniature ball lock quick disconnect couplings are designed for use with compressed air, gases and liquids.



Product Features

- Series 180 and 280 sockets/females mate with all Series 180 plugs/males
- Series 180 sockets/females have a tire valve
- Series 280 sockets/females have a 1HK valve, which provides higher flow capacity
- Chrome plating available as well as additional seal options
- Standard body material: Brass
- Standard seal material: Buna-N
- Interchange is proprietary to Danfoss

Physical Characteristics

Series	Body Size	Max. Operating Pressure		Min. Burst Pressure		Rated Flow	
	(in)	(bar)	(psi)	(bar)	(psi)	(lpm)	scfm
180	1/8	48	700	192	2,800	71	2.5
280	1/8	207	3,000	828	1,200	283	10

Applications & Markets

- Recreation and Entertainment
- Breathing Air
- General Pneumatics
- Pharmaceutical
- Laboratory Uses
- Medical

Flow Data

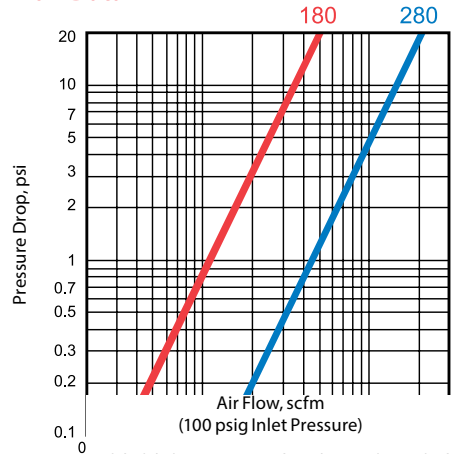

180/280 Series

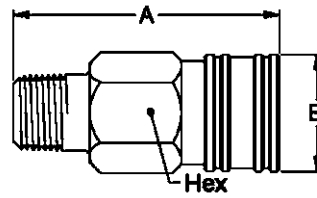

Figure 1

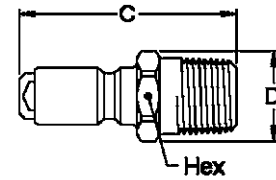

Figure 2

Male End Connections

Part Number	Coupling Type	Body Size	Port Size	Thread	Type	Fig.	Dimensions			A	B	Hex
							A	B	Hex			
							(in)	(in)	(in)	(mm)	(mm)	(mm)
180	Socket/Female	1/8	1/8	1/8-27	NPTF	1	1.42	0.63	0.56	36.1	16.0	14.2
28S25M	Socket/Female	1/8	1/4	1/4-18	NPTF	1	1.39	0.63	0.56	35.3	16.0	14.2

Part Number	Coupling Type	Body Size	Port Size	Thread	Type	Fig.	Dimensions			C	D	Hex
							C	D	Hex			
							(in)	(in)	(in)	(mm)	(mm)	(mm)
185E	Plug/Male	1/8	1/8	1/8-27	NPTF	2	1.16	0.51	0.44	29.5	13.0	11.2
186	Plug/Male	1/8	1/4	1/4-18	NPTF	2	1.44	0.63	0.56	36.6	16.0	14.2

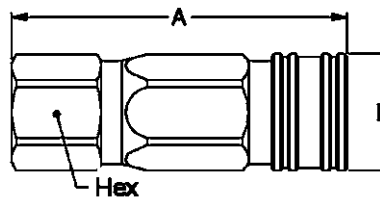

Figure 1

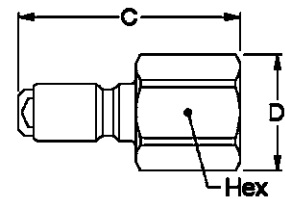

Figure 2

Female End Connections

Part Number	Coupling Type	Body Size	Port Size	Thread	Type	Fig.	Dimensions			A	B	Hex
							A	B	Hex			
							(in)	(in)	(in)	(mm)	(mm)	(mm)
28S12F	Socket/Female	1/8	1/8	1/8-27	NPTF	1	1.79	0.63	0.56	45.5	16.0	14.2

Part Number	Coupling Type	Body Size	Port Size	Thread	Type	Fig.	Dimensions			C	D	Hex
							C	D	Hex			
							(in)	(in)	(in)	(mm)	(mm)	(mm)
183	Plug/Male	1/8	1/8	1/8-27	NPTF	2	1.19	0.58	0.50	30.2	14.7	12.7

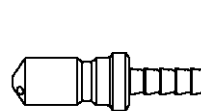

Figure 1

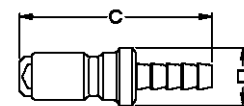

Figure 2

Hose Stem End Connections

Part Number	Coupling Type	Body Size	Hose I.D.	Fig.	Dimensions			
					C	D	C	D
					(in)	(in)	(mm)	(mm)
187	Plug/Male	1/8	1/8	1	1.25	0.38	31.8	9.7
189	Plug/Male	1/8	3/16	2	1.50	0.38	38.1	9.7

Full-Bore Series

Pneumatic application

Danfoss' Full-Bore Series is a premium automatic one-way shutoff quick disconnect coupling. Two sleeves must be actuated in sequence to bleed off back pressure and release the connector, preventing accidental uncoupling.



Product Features

- Pressure relieving feature fully vents downstream air, making connection/disconnection fast and easy, and eliminating hose whip
- Unique straight through design
- eliminates restrictive springs and poppet valves, allowing unimpeded air flow
- Two sleeve activation prevents accidental disconnect
- Standard body material: Zinc trivalent plated carbon steel
- Standard seal material: Buna-N

Physical Characteristics

Body Size (in)	Max. Operating Pressure		Min. Burst Pressure Rated Flow			
	(bar)	(psi)	(bar)	(psi)	(lpm)	(scfm)
3/8	15	250	60	1,000	1,784	63
1/2	15	250	60	1,000	2,860	101

Applications & Markets

- Construction
- Maintenance and Repair
- In-Plant/Industrial
- Railyards
- General Pneumatics

Flow Data

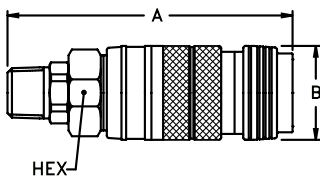
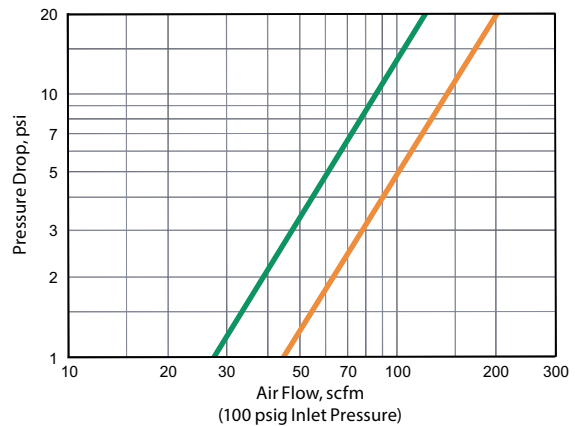

Figure 1

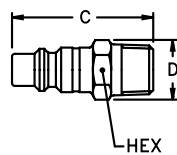
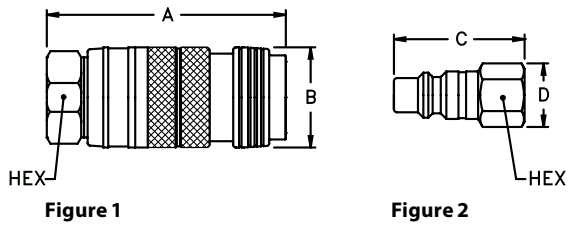

Figure 2

Male End Connections

Part Number	Coupling Type	Body Size	Port Size	Thread	Type	Fig.	Dimensions			A	B	Hex
							A	B	Hex			
							(in)	(in)	(in)	(mm)	(mm)	(mm)
23203013	Socket/Female	3/8	3/8	3/8-18	NPTF	1	3.80	1.25	1.00	96.5	31.8	25.4
23203014	Socket/Female	3/8	1/2	1/2-14	NPTF	1	4.10	1.25	1.00	71.1	31.8	25.4
23204014	Socket/Female	1/2	1/2	1/2-14	NPTF	1	4.43	1.38	1.13	112.5	35.1	28.7
23204015	Socket/Female	1/2	3/4	3/4-14	NPTF	1	4.67	1.38	1.13	118.6	35.1	28.7
Part Number	Coupling Type	Body Size	Port Size	Thread	Type	Fig.	Dimensions			C	D	Hex
							C	D	Hex			
							(in)	(in)	(in)	(mm)	(mm)	(mm)
40	Plug/Male	3/8	1/4	1/4-18	NPTF	2	1.88	0.72	0.63	47.8	18.3	16.0
42	Plug/Male	3/8	3/8	3/8-18	NPTF	2	1.88	0.79	0.69	47.8	20.1	17.5
44	Plug/Male	3/8	1/2	1/2-14	NPTF	2	2.09	1.01	0.88	53.1	25.7	22.4
52	Plug/Male	1/2	3/8	3/8-18	NPTF	2	2.25	0.87	0.75	57.2	22.1	19.1
54E	Plug/Male	1/2	1/2	1/2-14	NPTF	2	2.44	1.01	0.88	62.0	25.7	22.4
56	Plug/Male	1/2	3/4	3/4-14	NPTF	2	2.50	1.23	1.06	63.5	31.2	26.9

Full-Bore Series



Female End Connections

Part Number	Coupling Type	Body Size	Port Size	Thread	Type	Fig.	Dimensions			A	B	Hex
							A	B	Hex			
							(in)	(in)	(in)	(mm)	(mm)	(mm)
23203300	Socket/Female	3/8	3/8	3/8-18	NPTF	1	3.17	1.25	1.00	80.5	31.8	25.4
23203004	Socket/Female	3/8	1/2	1/2-14	NPTF	1	3.92	1.25	1.00	99.6	31.8	25.4
23204400	Socket/Female	1/2	1/2	1/2-14	NPTF	1	3.31	1.38	1.13	84.1	35.1	28.7
23204005	Socket/Female	1/2	3/4	3/4-14	NPTF	1	4.30	1.38	1.13	109.2	35.1	28.7

Part Number	Coupling Type	Body Size	Port Size	Thread	Type	Fig.	Dimensions			C	D	Hex
							C	D	Hex			
							(in)	(in)	(in)	(mm)	(mm)	(mm)
41	Plug/Male	3/8	1/4	1/4-18	NPTF	2	1.63	0.79	0.69	41.4	20.1	17.5
43	Plug/Male	3/8	3/8	3/8-18	NPTF	2	1.81	0.94	0.81	46.0	23.9	20.6
45E	Plug/Male	3/8	1/2	1/2-14	NPTF	2	2.06	1.15	1.00	52.3	29.2	25.4
53	Plug/Male	1/2	3/8	3/8-18	NPTF	2	2.06	0.94	0.81	52.3	23.9	20.6
55	Plug/Male	1/2	1/2	1/2-14	NPTF	2	2.34	1.15	1.00	59.4	29.2	25.4
57	Plug/Male	1/2	3/4	3/4-14	NPTF	2	2.44	1.37	1.19	62.0	34.8	30.2

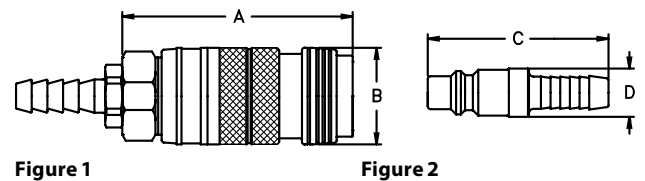

Hose Stem End Connections

Part Number	Coupling Type	Body Size	Hose I.D.	Fig.	Dimensions		A	B
					A	B		
					(in)	(in)	(mm)	(mm)
23203024	Socket/Female	3/8	1/4	1	4.36	1.25	110.7	31.8
23203025	Socket/Female	3/8	3/8	1	4.48	1.25	113.8	31.8
23204025	Socket/Female	1/2	1/2	1	4.80	1.38	121.9	35.1
23204026	Socket/Female	1/2	3/4	1	4.80	1.38	121.9	35.1

Part Number	Coupling Type	Body Size	Hose I.D.	Fig.	Dimensions		C	D
					C	D		
					(in)	(in)	(mm)	(mm)
404	Plug/Male	3/8	1/4	2	2.34	0.63	59.4	16.0
406	Plug/Male	3/8	3/8	2	2.34	0.63	59.4	16.0
408	Plug/Male	3/8	1/2	2	2.34	0.81	59.4	20.6
59	Plug/Male	1/2	3/8	2	2.66	0.69	67.6	17.5
60	Plug/Male	1/2	1/2	2	2.66	0.75	67.6	19.1
61E	Plug/Male	1/2	3/4	2	3.50	1.00	88.9	25.4

Gas-Mate Series

Pneumatic application

Danfoss' Gas-Mate™ Series quick disconnect couplings are a one-way shut-off safety couplings designed for the connection of gas fired devices or applications.



Product Features

- Connect and disconnect without the need for wrenches
- Automatic shut off when plug is removed from socket
- In case of fire, heat sensitive plug allows socket valve to close, stopping gas flow
- Tested to meet operating temperatures -40°F to 200°F (-40°C to 93°C) in sizes 3/8", 1/2", 3/4", and 1" when used in accordance with the CSA standard ANSI Z21.41b-2010/CSA 6.9b-2010 in both indoor and outdoor applications. Please note that the 1 1/4" size coupling is rated for indoor use only.
- Standard body material: Brass

Physical Characteristics

Sizes	Max. Operating Pressure		Min. Burst Pressure	
	(bar)	(psi)	(bar)	(psi)
All sizes	0.03	0.5	68	1,000

Applications & Markets

- Industrial
- Fuel Gas Systems
- Food & Beverage



*CSA design certified, in both the United States and Canada, for natural gas, manufactured gas, liquified petroleum and LP gas-air mixtures at pressures not in excess of 1/2 psig (3.5 kPa).

Capacities

Body Size (in)	Socket/Female P/N	Plug/Male P/N	Capacity (btu/hr)
3/8	100006E	100506	60,000
1/2	100008	100508	90,000
3/4	100010	100510	245,000
1	100012E	100512	310,000
1 1/4	GMS1250FH	GMP1250F	500,000

*Capacity is based on natural gas having a specific gravity of 0.64 and heat capacity of 1,000 BTU per cubic foot. Inlet pressure is 12 inches water column and the pressure drop is 0.3 inch water column.

Gas-Mate Series

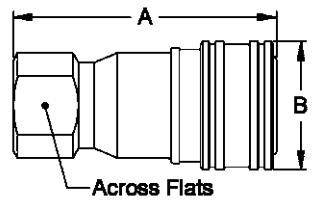

Figure 1

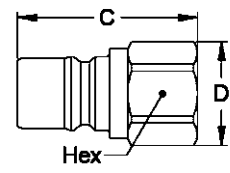

Figure 2

Sockets/Females

Part Number	Coupling Type	Body Size	Port Size	Thread	Type	Fig.	Dimensions			A	B	Across Flats
							A	B	Across Flats			
							(in)	(in)	(in)	(mm)	(mm)	(mm)
100006E	Socket/Female	3/8	3/8	3/8-18	NPTF	1	2.44	1.13	0.87	62.0	28.7	22.1
100008	Socket/Female	1/2	1/2	1/2-14	NPTF	1	2.84	1.38	1.00	72.1	35.1	25.4
100010	Socket/Female	3/4	3/4	3/4-14	NPTF	1	3.17	1.75	1.31	80.5	44.5	33.3
100012E	Socket/Female	1	1	1-11 1/2	NPTF	1	3.94	2.13	1.50	100.1	54.1	38.1

Part Number	Coupling Type	Body Size	Port Size	Thread	Type	Fig.	Dimensions			A	B	Hex
							A	B	Hex			
							(in)	(in)	(in)	(mm)	(mm)	(mm)
GMS1250FH*	Socket/Female	1 1/4	1 1/4	1 1/4-11 1/2	NPTF	3	4.15	2.28	2.00	105.4	57.9	50.8

*For indoor use only

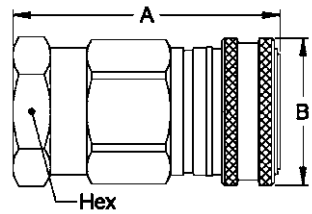

Figure 3

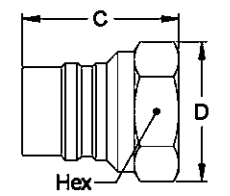

Figure 4

Plugs/Males

Part Number	Coupling Type	Body Size	Port Size	Thread	Type	Fig.	Dimensions			C	D	Hex
							C	D	Hex			
							(in)	(in)	(in)	(mm)	(mm)	(mm)
100506	Plug/Male	3/8	3/8	3/8-18	NPTF	2	1.59	0.94	0.81	40.4	23.9	20.6
100508	Plug/Male	1/2	1/2	1/2-14	NPTF	2	1.94	1.15	1.00	49.3	29.2	25.4
100510	Plug/Male	3/4	3/4	3/4-14	NPTF	2	2.06	1.51	1.31	52.3	38.4	33.3
100512	Plug/Male	1	1	1-11 1/2	NPTF	2	2.47	1.73	1.50	62.7	43.9	38.1
GMP1250F*	Plug/Male	1 1/4	1 1/4	1 1/4-11 1/2	NPTF	4	2.44	2.17	1.88	62.0	55.1	47.8

*For indoor use only

Dust Caps and Dust Plugs

Series	Dust Cap		Dust Plug	
	Metal	Vinyl	Metal	Vinyl
3/8	XPDC2HK*	XPPDC2HK	XPDC2HK*	XPPDC2HK
1/2	XPDC3HK*	XPPDC3HK	XPDC3HK*	XPPDC3HK
3/4	XPDC4HK**	XPPDC4HK	XPDC4HK**	XPPDC4HK
1	XPDC6HK**	XPPDC6HK	XPDC6HK**	XPPDC6HK

*Brass
**Aluminum



CANADIAN STANDARDS ASSOCIATION*

Complies with the requirements of ANSI Z21.41B-2010/CSA 6.96-2010.

*CSA design certified, in both the United States and Canada, for natural gas, manufactured gas, propane gas and LP gas-air mixtures at pressures not in excess of 1/2 psig (3.5 kPa).

2RL/3RL Series

Pneumatic application

Danfoss' 2RL/3RL ring lock series quick disconnect pneumatic couplings have a unique interchange which Danfoss designed for use with compressed air.



Product Features

- High Flow capacity
- Push to connect with a ring lock sleeve
- Ring lock design prevents accidental disconnection
- To disconnect rotate sleeve 20 degrees
- Standard body material: Zinc trivalent plated steel
- Standard seal material: Buna-N
- Optional seal materials: Silicone-138, FKM-143, EPDM-192

Physical Characteristics

Series	Coupling Size (in)	Max. Operating Pressure		Min. Burst Pressure		Rated Flow	
		(bar)	(psi)	(bar)	(psi)	(lpm)	scfm
2RL	1/4	20	300	80	1,200	1,350	48
3RL	3/8	20	300	80	1,200	2,250	80

Applications & Markets

- Shipyards
- General Pneumatics
- Mining
- Marine

Flow Data

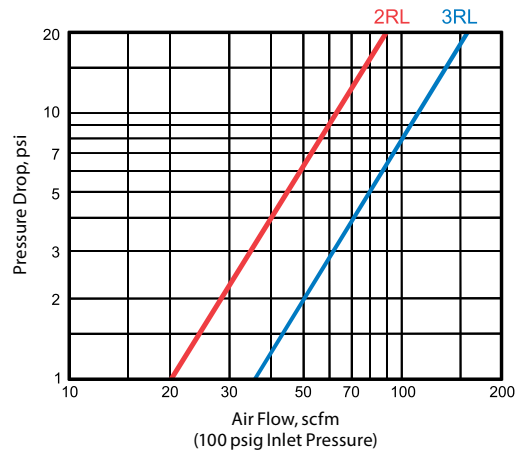

2RL Series

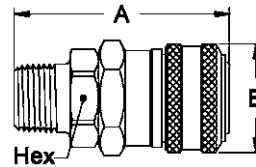

Figure 1

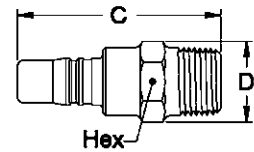

Figure 2

Male End Connections

Part Number	Coupling Type	Body Size	Port Size	Thread	Type	Fig.	Dimensions			A	B	Hex
							A	B	Hex			
							(in)	(in)	(in)	(mm)	(mm)	(mm)
2R10	Socket/Female	1/4	1/8	1/8-27	NPTF	1	2.01	1.06	0.88	51.1	26.9	22.4
2R15	Socket/Female	1/4	1/4	1/4-18	NPTF	1	2.16	1.06	0.88	54.9	26.9	22.4
2R20	Socket/Female	1/4	3/8	3/8-18	NPTF	1	2.16	1.06	0.88	54.9	26.9	22.4
2R25	Socket/Female	1/4	1/2	1/2-14	NPTF	1	2.35	1.06	0.88	59.7	26.9	22.4

Part Number	Coupling Type	Body Size	Port Size	Thread	Type	Fig.	Dimensions			C	D	Hex
							C	D	Hex			
							(in)	(in)	(in)	(mm)	(mm)	(mm)
2L10	Plug/Male	1/4	1/8	1/8-27	NPTF	2	1.51	0.58	0.50	38.4	14.7	12.7
2L15	Plug/Male	1/4	1/4	1/4-18	NPTF	2	1.66	0.65	0.56	42.2	16.5	14.2
2L15G†	Plug/Male	1/4	1/4	1/4-18	NPTF	2	2.64	0.77	0.69	67.1	19.6	17.5
2L20	Plug/Male	1/4	3/8	3/8-18	NPTF	2	2.04	0.79	0.69	51.8	20.1	17.5
2L20G†	Plug/Male	1/4	3/8	3/8-18	NPTF	2	2.64	0.77	0.69	67.1	19.6	17.5
2L25	Plug/Male	1/4	1/2	1/2-14	NPTF	2	2.31	1.01	0.88	58.7	25.7	22.4

†With Bleeder Ball Check—Reduces Hose Whip

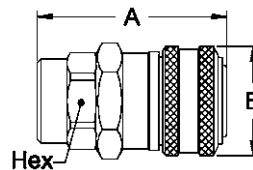

Figure 1

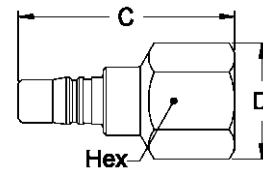

Figure 2

Female End Connections

Part Number	Coupling Type	Body Size	Port Size	Thread	Type	Fig.	Dimensions			A	B	Hex
							A	B	Hex			
							(in)	(in)	(in)	(mm)	(mm)	(mm)
2R11	Socket/Female	1/4	1/8	1/8-27	NPTF	1	1.91	1.06	0.88	48.5	26.9	22.4
2R16	Socket/Female	1/4	1/4	1/4-18	NPTF	1	1.91	1.06	0.88	48.5	26.9	22.4
2R21	Socket/Female	1/4	3/8	3/8-18	NPTF	1	2.16	1.06	0.88	54.9	26.9	22.4
2R26	Socket/Female	1/4	1/2	1/2-14	NPTF	1	2.43	1.06	1.00	61.7	26.9	25.4

Part Number	Coupling Type	Body Size	Port Size	Thread	Type	Fig.	Dimensions			C	D	Hex
							C	D	Hex			
							(in)	(in)	(in)	(mm)	(mm)	(mm)
2L11	Plug/Male	1/4	1/8	1/8-27	NPTF	2	1.36	0.65	0.56	34.5	16.5	14.2
2L16	Plug/Male	1/4	1/4	1/4-18	NPTF	2	1.54	0.79	0.69	39.1	20.1	17.5
2L16G†	Plug/Male	1/4	1/4	1/4-18	NPTF	2	2.55	0.77	0.69	64.8	19.6	17.5
2L21	Plug/Male	1/4	3/8	3/8-18	NPTF	2	1.88	0.94	0.81	47.8	23.9	20.6
2L26	Plug/Male	1/4	1/2	1/2-14	NPTF	2	2.18	1.15	1.00	55.4	29.2	25.4

†With Bleeder Ball Check—Reduces Hose Whip

2RL Series

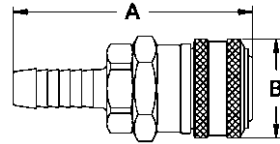

Figure 1

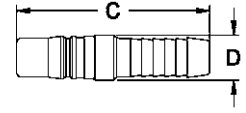

Figure 2

Hose Stem End Connections

Part Number	Coupling Type	Body Size	Hose I.D.	Fig.	Dimensions			
					A (in)	B (in)	A (mm)	B (mm)
2R17	Socket/Female	1/4	1/4	1	2.63	1.06	66.8	26.9
2R195	Socket/Female	1/4	5/16	1	2.63	1.06	66.8	26.9
2R22	Socket/Female	1/4	3/8	1	2.63	1.06	66.8	26.9
2R27	Socket/Female	1/4	1/2	1	2.63	1.06	66.8	26.9
Part Number	Coupling Type	Body Size	Hose I.D.	Fig.	Dimensions			
					C (in)	D (in)	C (mm)	D (mm)
2L17	Plug/Male	1/4	1/4	2	2.13	0.50	54.1	12.7
2L195	Plug/Male	1/4	5/16	2	2.13	0.50	54.1	12.7
2L22	Plug/Male	1/4	3/8	2	2.13	0.50	54.1	12.7
2L27	Plug/Male	1/4	1/2	2	2.5	0.81	63.5	20.6

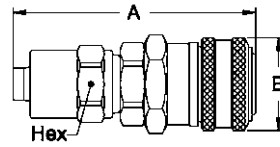

Figure 1

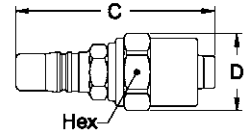

Figure 2

Hose Clamp End Connections

Part Number	Coupling Type	Body Size	Hose I.D.	Hose O.D.	Fig.	Dimensions			A (mm)	B (mm)	Hex (mm)
						A (in)	B (in)	Hex (in)			
2R18B1	Socket/Female	1/4	1/4	15/32	1	2.73	1.06	0.63	69.3	26.9	16.00
2R18B3	Socket/Female	1/4	1/4	1/2	1	2.73	1.06	0.63	69.3	26.9	16.00
2R18B7	Socket/Female	1/4	1/4	5/8	1	2.73	1.06	0.75	69.3	26.9	19.05
2R18B11	Socket/Female	1/4	1/4	3/4	1	2.73	1.06	0.88	69.3	26.9	22.35
2R185C7	Socket/Female	1/4	5/16	5/8	1	2.79	1.06	0.75	70.9	26.9	19.05
2R185C9	Socket/Female	1/4	5/16	11/16	1	2.79	1.06	0.81	70.9	26.9	20.57
2R23D7	Socket/Female	1/4	3/8	5/8	1	2.85	1.06	0.75	72.4	26.9	19.05
2R23D9	Socket/Female	1/4	3/8	11/16	1	2.85	1.06	0.81	72.4	26.9	20.57
2R23D11	Socket/Female	1/4	3/8	3/4	1	2.85	1.06	0.88	72.4	26.9	22.35
2R23D13	Socket/Female	1/4	3/8	13/16	1	2.85	1.06	0.94	72.4	26.9	23.88
2R28P13	Socket/Female	1/4	1/2	13/16	1	3.48	1.06	0.94	88.4	26.9	23.88
2R28P15	Socket/Female	1/4	1/2	7/8	1	3.48	1.06	1.00	88.4	26.9	25.40
Part Number	Coupling Type	Body Size	Hose I.D.	Hose O.D.	Fig.	Dimensions			C (mm)	D (mm)	Hex (mm)
						C (in)	D (in)	Hex (in)			
2L18B3	Plug/Male	1/4	1/4	1/2	2	2.23	0.70	0.63	56.6	17.8	16.00
2L185C7	Plug/Male	1/4	5/16	5/8	2	2.29	0.84	0.75	58.2	21.3	19.05
2L185C9	Plug/Male	1/4	5/16	11/16	2	2.29	0.91	0.81	58.2	23.1	20.57
2L23D5	Plug/Male	1/4	3/8	9/16	2	2.35	0.77	0.69	59.7	19.6	17.53
2L23D7	Plug/Male	1/4	3/8	5/8	2	2.35	0.84	0.75	59.7	21.3	19.05
2L23D9	Plug/Male	1/4	3/8	11/16	2	2.35	0.91	0.81	59.7	23.1	20.57
2L23D11	Plug/Male	1/4	3/8	3/4	2	2.35	0.98	0.88	59.7	24.9	22.35
2L23D13	Plug/Male	1/4	3/8	13/16	2	2.35	1.05	0.94	59.7	26.7	23.88
2L28P13	Plug/Male	1/4	1/2	13/16	2	3.41	1.05	0.94	86.6	26.7	23.88
2L28P15	Plug/Male	1/4	1/2	7/8	2	3.41	1.12	1.00	86.6	28.4	25.40

3RL Series

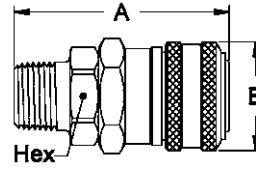

Figure 1

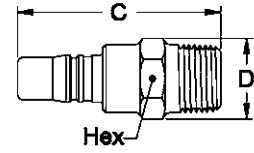

Figure 2

Male End Connections

Part Number	Coupling Type	Body Size	Port Size	Thread	Type	Fig.	Dimensions			A	B	Hex
							A	B	Hex			
							(in)	(in)	(in)	(mm)	(mm)	(mm)
3R15	Socket/Female	3/8	1/4	1/4-18	NPTF	1	2.34	1.31	1.00	59.4	33.3	25.4
3R20	Socket/Female	3/8	3/8	3/8-18	NPTF	1	2.35	1.31	1.00	59.7	33.3	25.4
3R25	Socket/Female	3/8	1/2	1/2-14	NPTF	1	2.54	1.31	1.00	64.5	33.3	25.4
3R30	Socket/Female	3/8	3/4	3/4-14	NPTF	1	2.54	1.31	1.06	64.5	33.3	26.9
Part Number	Coupling Type	Body Size	Port Size	Thread	Type	Fig.	Dimensions			C	D	Hex
							C	D	Hex			
							(in)	(in)	(in)	(mm)	(mm)	(mm)
3L10	Plug/Male	3/8	1/8	1/8-27	NPTF	2	1.54	0.72	0.63	39.1	18.3	16.0
3L15	Plug/Male	3/8	1/4	1/4-18	NPTF	2	1.70	0.72	0.63	43.2	18.3	16.0
3L15G†	Plug/Male	3/8	1/4	1/4-18	NPTF	2	2.64	0.98	0.88	67.1	24.9	22.4
3L20	Plug/Male	3/8	3/8	3/8-18	NPTF	2	1.76	0.79	0.69	44.7	20.1	17.5
3L20G†	Plug/Male	3/8	3/8	3/8-18	NPTF	2	2.64	0.98	0.88	67.1	24.9	22.4
3L25	Plug/Male	3/8	1/2	1/2-14	NPTF	2	2.31	1.01	0.88	58.7	25.7	22.4
3L25G†	Plug/Male	3/8	1/2	1/2-14	NPTF	2	2.83	0.98	0.88	71.9	24.9	22.4
3L30	Plug/Male	3/8	3/4	3/4-14	NPTF	2	2.38	1.23	1.06	60.5	31.2	26.9
3L30G†	Plug/Male	3/8	3/4	3/4-14	NPTF	2	2.88	1.19	1.06	73.2	30.2	26.9

†With Bleeder Ball Check—Reduces Hose Whip

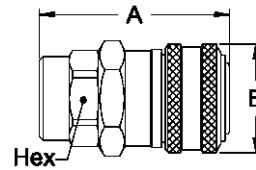

Figure 1

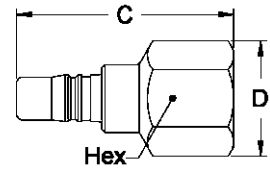

Figure 2

Female End Connections

Part Number	Coupling Type	Body Size	Port Size	Thread	Type	Fig.	Dimensions			A	B	Hex
							A	B	Hex			
							(in)	(in)	(in)	(mm)	(mm)	(mm)
3R16	Socket/Female	3/8	1/4	1/4-18	NPTF	1	2.29	1.31	1.00	58.2	33.3	25.4
3R21	Socket/Female	3/8	3/8	3/8-18	NPTF	1	2.35	1.31	1.00	59.7	33.3	25.4
3R26	Socket/Female	3/8	1/2	1/2-14	NPTF	1	2.63	1.31	1.00	66.8	33.3	25.4
3R31A	Socket/Female	3/8	3/4	3/4-14	NPTF	1	2.66	1.31	1.19	67.6	33.3	30.2
Part Number	Coupling Type	Body Size	Port Size	Thread	Type	Fig.	Dimensions			C	D	Hex
							C	D	Hex			
							(in)	(in)	(in)	(mm)	(mm)	(mm)
3L16	Plug/Male	3/8	1/4	1/4-18	NPTF	2	1.48	0.79	0.69	37.6	20.1	17.5
3L16G†	Plug/Male	3/8	1/4	1/4-18	NPTF	2	2.39	0.98	0.88	60.7	24.9	22.4
3L21	Plug/Male	3/8	3/8	3/8-18	NPTF	2	1.63	0.94	0.81	41.4	23.9	20.6
3L26	Plug/Male	3/8	1/2	1/2-14	NPTF	2	2.25	1.15	1.00	57.2	29.2	25.4
3L26G†	Plug/Male	3/8	1/2	1/2-14	NPTF	2	2.91	0.98	1.00	73.9	24.9	25.4
3L31	Plug/Male	3/8	3/4	3/4-14	NPTF	2	2.25	1.37	1.19	57.2	34.8	30.2

†With Bleeder Ball Check—Reduces Hose Whip

3RL Series

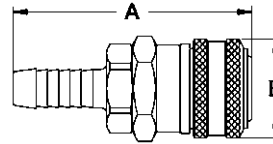

Figure 1

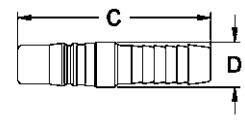

Figure 2

Hose Stem End Connections

Part Number	Coupling Type	Body Size	Hose I.D.	Fig.	Dimensions			
					A (in)	B (in)	A (mm)	B (mm)
3R17	Socket/Female	3/8	1/4	1	2.85	1.31	72.4	33.3
3R195	Socket/Female	3/8	5/16	1	2.85	1.31	72.4	33.3
3R22	Socket/Female	3/8	3/8	1	2.89	1.31	73.4	33.3
3R27	Socket/Female	3/8	1/2	1	2.81	1.31	71.4	33.3
3R32	Socket/Female	3/8	3/4	1	3.66	1.31	93.0	33.3

Part Number	Coupling Type	Body Size	Hose I.D.	Fig.	Dimensions			
					C (in)	D (in)	C (mm)	D (mm)
3L17	Plug/Male	3/8	1/4	2	2.16	0.63	54.9	16.0
3L17G†	Plug/Male	3/8	1/4	2	3.11	0.98	79.0	24.9
3L195	Plug/Male	3/8	5/16	2	2.16	0.63	54.9	16.0
3L195G†	Plug/Male	3/8	5/16	2	3.11	0.98	79.0	24.9
3L22	Plug/Male	3/8	3/8	2	2.16	0.75	54.9	19.1
3L22G†	Plug/Male	3/8	3/8	2	3.11	0.98	79.0	24.9
3L27	Plug/Male	3/8	1/2	2	2.16	0.81	54.9	20.6
3L27G†	Plug/Male	3/8	1/2	2	3.11	0.98	79.0	24.9
3L32	Plug/Male	3/8	3/4	2	3.13	1.00	79.5	25.4
3L32G†	Plug/Male	3/8	3/4	2	3.96	0.98	100.6	24.9

†With Bleeder Ball Check—Reduces Hose Whip

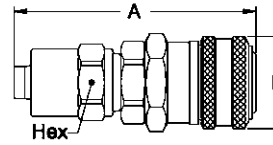

Figure 1

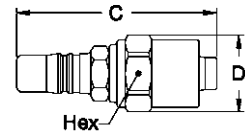

Figure 2

Hose Clamp End Connections

Part Number	Coupling Type	Body Size	Hose I.D.	Hose O.D.	Fig.	Dimensions			A (mm)	B (mm)	Hex (mm)
						A (in)	B (in)	Hex (in)			
3R23D7	Socket/Female	3/8	3/8	5/8	1	3.06	1.31	0.75	77.7	33.3	19.05
3R23D9	Socket/Female	3/8	3/8	11/16	1	3.06	1.31	0.81	77.7	33.3	20.57
3R23D11	Socket/Female	3/8	3/8	3/4	1	3.06	1.31	0.88	77.7	33.3	22.35
3R28P13	Socket/Female	3/8	1/2	13/16	1	3.66	1.31	0.94	93.0	33.3	23.88
3R28P15	Socket/Female	3/8	1/2	7/8	1	3.66	1.31	1.00	93.0	33.3	25.40
3R28P17	Socket/Female	3/8	1/2	15/16	1	3.66	1.31	1.06	93.0	33.3	26.92
3R33R23	Socket/Female	3/8	3/4	1 1/8	1	3.79	1.31	1.25	96.3	33.3	31.75
3R33R25	Socket/Female	3/8	3/4	1 3/16	1	3.79	1.31	1.31	96.3	33.3	33.27

Part Number	Coupling Type	Body Size	Hose I.D.	Hose O.D.	Fig.	Dimensions			C (mm)	D (mm)	Hex (mm)
						C (in)	D (in)	Hex (in)			
3L23D7	Plug/Male	3/8	3/8	5/8	2	2.45	0.84	0.75	62.2	21.3	19.05
3L23D9	Plug/Male	3/8	3/8	11/16	2	2.45	0.91	0.81	62.2	23.1	20.57
3L23D11	Plug/Male	3/8	3/8	3/4	2	2.45	0.98	0.88	62.2	24.9	22.35
3L28P13	Plug/Male	3/8	1/2	13/16	2	3.14	1.05	0.94	79.8	26.7	23.88
3L28P15	Plug/Male	3/8	1/2	7/8	2	3.14	1.12	1.00	79.8	28.4	25.40
3L33R23	Plug/Male	3/8	3/4	1 1/8	2	3.56	1.40	1.25	90.4	35.6	31.75
3L33R25	Plug/Male	3/8	3/4	1 3/16	2	3.56	1.47	1.31	90.4	37.3	33.27

Dust Caps and Dust Plugs

Series	Dust Cap	Dust Plug
2RL	XPPDC1HK	XPSDC1HK
3RL	XPPDC2HK	XPSDC2HK



Flex-Air Series

Pneumatic application



Danfoss' Flex-Air™ fittings are designed to rotate 360 degrees up to a 75° angle. These fittings help to alleviate Carpal Tunnel Syndrome and other stress related injuries in the workplace.

Product Features

- Unique design provides free 360 degree rotation with up to a 75° flex angle in any direction
- Many styles and sizes available
- Prevents kinking of air supply hose

Physical Characteristics

Sizes	Max. Operating Pressure		Min. Burst Pressure	
	(bar)	(psi)	(bar)	(psi)
All sizes	10	145	40	580

Applications & Markets

- General Industry
- Pneumatic Tools

Flex-Air Series

Part Number	Type	Fig.	Connector Ends	ID
FA25F25M	Female to Male	1	1/4" NPT Female & 1/4" NPT Male	0.2" (5 mm)
FA25F37M	Female to Male	2	1/4" NPT Female & 3/8" NPT Male	0.3" (7.5 mm)
FA37F37M	Female to Male	3	3/8" NPT Female & 3/8" NPT Male	0.3" (7.5 mm)
FA37H37M	Hose Barb to Male	4	3/8" Barb & 3/8" NPT Male	0.3" (7.5 mm)
FA25M25M	Male to Male	5	1/4" NPT Male & 1/4" NPT Male	0.2" (5 mm)
FA37M37M	Male to Male	6	3/8" NPT Male & 3/8" NPT Male	0.3" (7.5 mm)
FA25AR25M	ARO to Male	7	ARO 210 Interchange & 1/4" NPT	0.2" (5 mm)
FA25P25M	Industrial Plug to Male	8	1/4" Industrial Interchange & 1/4" NPT Male	0.2" (5 mm)
FA37P25M	Industrial Plug to Male	9	3/8" Industrial Interchange & 1/4" NPT Male	0.3" (7.5 mm)



Figure 1



Figure 5



Figure 8

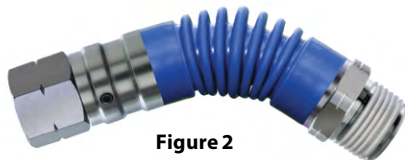

Figure 2



Figure 6



Figure 9



Figure 3



Figure 7



Figure 4

Blow-Guns

Pneumatic application

Danfoss offers two styles of blow-guns to fit your application needs.



Product Features

100 Series

- Progressive flow-control
- The airtight version protects the operator against particle blow-back
- Body material: Nickel-plated brass
- Seals: NBR

200 Series

- Pressure reduces to 2 bar(30 PSI) if the nozzle is obstructed by an obstacle
- Complies with OSHA STD 01-13-2001 standard
- When in use, the gun is designed to produce low noise levels with the comfort of the operator in mind. Complies with Directive 2003/10/EC and OSHA 1910.95(b) standard
- The "soft touch" trigger and ergonomic design make it easy to grip and handle, even with work gloves. The graduated-opening system enables the operator to adjust the flow rate to his/her requirements.
- Body material: Nylon
- Nozzle: Stainless steel
- Seals: NBR

Physical Characteristics

Series	Type	Connection	Max. Operating Pressure		Temperature Range	
			(bar)	(psi)	C	F
100	Metal	G 1/4	20	290	+100C/ -20C	+212F/-4F
200	Plastic	G 1/4	10	145	+70C/-20C	+158F/-4F

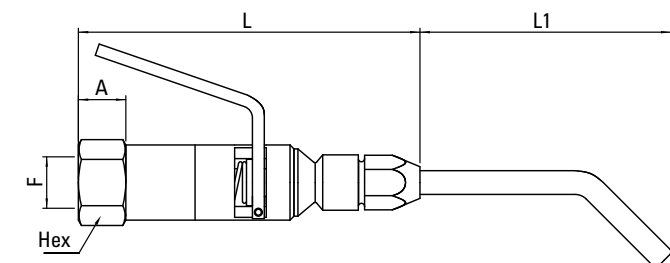

Figure 1

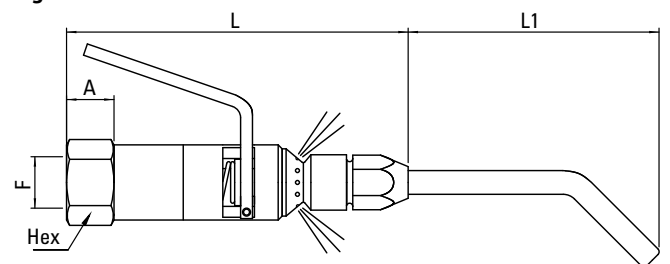

Figure 2 Series 100

Applications & Markets

- Pneumatic
- Manufacturing and Assembly

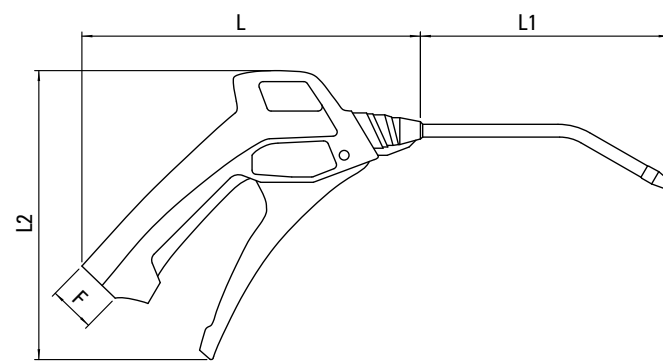

Figure 3 Series 200

Series	Part Number	Description	Fig.	F	L	L1	Hex	A	Weight
				(mm)	(mm)	(mm)	(mm)	(g)	
100	SA0017014	Progressive-flow blow-gun	1	G1/4	90	65	19	12	150
100	SA0017514	Blow-gun with airtight	2	G1/4	90	65	19	12	150

Series	Part Number	Description	Fig.	F	L	L1	L2	Weight
				(mm)	(mm)	(mm)	(g)	
200	SP0020014	Blow-gun with metal nozzle	3	G1/4	153	105	130	140

Adapters

Pneumatic application



200 Series



700 Series

Product Features

200 Series

- Zinc-plated steel

700 Series

- Zinc-plated steel
- *EL is brass

Physical Characteristics

Series	Max. Operating Pressure	
	(bar)	(psi)
200	120-250	1740-3625
700	35	508

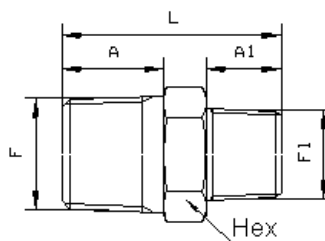

Figure 1

200 Series

Male BSP Taper Nipple				Dimensions						
Connection F	Connection F1	Part Number	Fig.	L	A	Hex	A1	Weight	Pressure	
				(mm)	(mm)	(mm)	(mm)	(g)	(bar)	
R 1/8	R 1/8	MA0024318	1	26	10	12	10	13	250	
R 1/4	R 1/8	MA0024484	1	31	14	14	10	20	250	
R 3/8	R 1/8	MA0024588	1	32	15	17	9	29	250	
R 1/4	R 1/4	MA0024314	1	35	14	14	14	25	250	
R 3/8	R 1/4	MA0024448	1	36	15	17	14	34	250	
R 1/2	R 1/4	MA0024524	1	41	19	22	14	62	250	
R 3/8	R 3/8	MA0024338	1	37	15	17	15	39	250	
R 1/2	R 3/8	MA0024482	1	42	19	22	15	67	250	
R 3/4	R 3/8	MA0024548	1	44	20	27	15	95	175	
R 1/2	R 1/2	MA0024312	1	46	19	22	19	68	250	
R 3/4	R 1/2	MA0024424	1	48	20	27	19	94	175	
R 1	R 1/2	MA0024512	1	53	24	36	19	191	150	
R 3/4	R 3/4	MA0024334	1	49	20	27	20	107	175	
R 1	R 3/4	MA0024441	1	54	24	36	20	182	150	
R 1	R 1	MA0024310	1	58	24	36	24	205	150	

Adapters

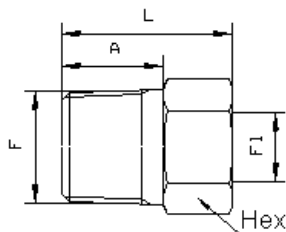

Figure 2

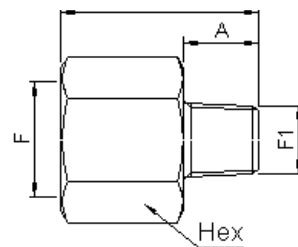

Figure 3

200 Series (cont.)

Reducing Bush									
Connection F	Connection F1	Part Number	Fig.	Dimensions			Weight	Pressure	
				L	A	Hex			
				(mm)	(mm)	(mm)	(g)	(bar)	
R 1/4	G 1/8	MA0025548	2	21	14	14	14	250	
R 3/8	G 1/8	MA0025688	2	22	15	17	27	250	
R 3/8	G 1/4	MA0025584	2	23	15	19	20	250	
R 1/2	G 1/4	MA0025624	2	27	19	22	49	250	
R 1/2	G 3/8	MA0025528	2	27	19	22	37	250	
R 3/4	G 3/8	MA0025648	2	29	20	27	77	175	
R 3/4	G 1/2	MA0025542	2	29	20	27	52	175	
R 1	G 1/2	MA0025612	2	34	24	36	139	150	
R 1	G 3/4	MA0025514	2	34	24	36	100	150	

Female/Male Reducer									
Connection F	Connection F1	Part Number	Fig.	Dimensions			Weight	Pressure	
				L	A	Hex			
				(mm)	(mm)	(mm)	(g)	(bar)	
G 1/4	R 1/8	MA0024248	3	31	10	19	40	250	
G 3/8	R 1/8	MA0026888	3	32	10	22	49	250	
G 3/8	R 1/4	MA0024284	3	35	14	22	46	250	
G 1/2	R 1/4	MA0026824	3	41	14	27	84	250	
G 1/2	R 3/8	MA0024228	3	40	15	27	80	250	
G 3/4	R 3/8	MA0026848	3	44	15	36	172	175	
G 3/4	R 1/2	MA0024242	3	47	19	32	125	175	
G 1	R 1/2	MA0026812	3	56	19	41	230	150	
G 1	R 3/4	MA0024214	3	55	20	41	240	150	

Adapters

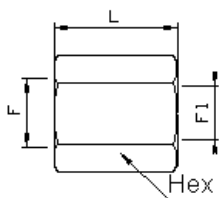

Figure 1

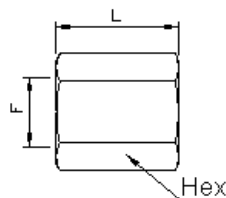

Figure 2

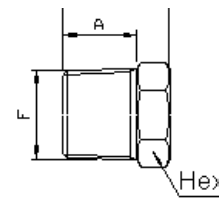

Figure 3

200 Series (cont.)

Reducing Socket									
Connection F	Connection F1	Part Number	Fig.	Dimensions			Weight	Pressure	
				L	A	Hex			
				(mm)	(mm)	(mm)	(g)	(bar)	
G 1/4	G 1/8	MA0026748	1	24	-	19	39	250	
G 3/8	G 1/4	MA0026784	1	27	-	22	53	250	
G 1/2	G 3/8	MA0026728	1	32	-	27	89	250	
G 3/4	G 1/2	MA0026742	1	36	-	32	126	175	
G 1	G 3/4	MA0026714	1	45	-	41	131	150	

Equal Socket									
Connection F	Connection F1	Part Number	Fig.	Dimensions			Weight	Pressure	
				L	A	Hex			
				(mm)	(mm)	(mm)	(g)	(bar)	
G 1/8	-	MA0026918	2	20	-	14	17	250	
G 1/4	-	MA0026914	2	25	-	19	35	250	
G 3/8	-	MA0026938	2	27	-	22	45	250	
G 1/2	-	MA0026912	2	35	-	27	76	250	
G 3/4	-	MA0026934	2	40	-	32	113	175	
G 1	-	MA0026910	2	45	-	41	217	150	

Male-Threaded Cap									
Connection F	Connection F1	Part Number	Fig.	Dimensions			Weight	Pressure	
				L	A	Hex			
				(mm)	(mm)	(mm)	(g)	(bar)	
R 1/8	-	MA0026618	3	16	10	12	10	250	
R 1/4	-	MA0026614	3	21	14	14	22	250	
R 3/8	-	MA0026638	3	22	15	17	31	250	
R 1/2	-	MA0026612	3	27	19	22	55	250	
R 3/4	-	MA0026634	3	29	20	27	89	175	
R 1	-	MA0026610	3	34	24	36	164	150	

Adapters

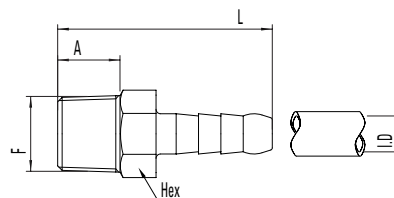

Figure 1

700 Series

Male-Threaded Hose Tail				Dimensions			
Connection F	Hose I.D.	Part Number	Fig.	L	A	Hex	Weight
	(mm)			(mm)	(mm)	(mm)	(g)
R 1/8	6	EL0070267	1	32	7.5	12	10
R 1/8	7	EA0070278	1	41	9	14	15
R 1/8	8	EA0070289	1	41	9	14	16
R 1/8	9	EA0070290	1	41	9	14	18
R 1/4	6	EA0070467	1	45	13	14	18
R 1/4	7	EA0070478	1	45	13	14	19
R 1/4	8	EA0070489	1	45	13	14	20
R 1/4	9	EA0070490	1	45	13	14	20
R 1/4	10	EA0070401	1	45	13	14	21
R 1/4	11	EA0070411	1	50	13	14	24
R 1/4	12	EA0070412	1	50	13	17	31
R 1/4	13	EA0070413	1	50	13	17	36
R 3/8	7	EA0070678	1	48	14	17	31
R 3/8	8	EA0070689	1	48	14	17	32
R 3/8	9	EA0070690	1	48	14	17	33
R 3/8	10	EA0070601	1	48	14	17	33
R 3/8	11	EA0070611	1	49	14	17	33
R 3/8	12	EA0070612	1	53	14	17	36
R 3/8	13	EA0070613	1	53	14	19	43
R 3/8	16	EA0070616	1	60	14	19	50
R 1/2	8	EA0070889	1	52	17	22	50
R 1/2	11	EA0070811	1	57	17	22	55
R 1/2	12	EA0070812	1	57	17	22	55
R 1/2	13	EA0070813	1	57	17	22	58
R 1/2	16	EA0070816	1	63	17	22	61
R 1/2	19	EA0070819	1	69	17	22	73
R 3/4	16	EA0071016	1	65	19	27	85
R 3/4	19	EA0071019	1	71	19	27	100
R 3/4	25	EA0071025	1	77	19	27	130
R 1	19	EA0072019	1	76	22	35	165
R 1	25	EA0072025	1	82	22	35	203
R 1	30	EA0072030	1	94	22	35	270

Adapters

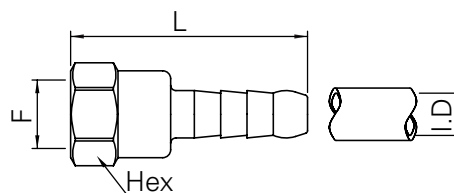

Figure 2

700 Series (cont.)

Female-Threaded Hose Tail							
Connection F	Hose I.D. (mm)	Part Number	Fig.	Dimensions			Weight (g)
				L (mm)	A (mm)	Hex (mm)	
G 1/4	6	EA0078167	2	45	-	17	23
G 1/4	7	EA0078178	2	45	-	17	23
G 1/4	8	EA0078189	2	45	-	17	25
G 1/4	9	EA0078190	2	45	-	17	26

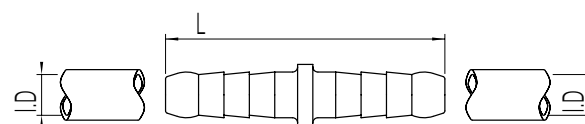

Figure 3

Hose Splicer							
Connection F	Hose I.D. (mm)	Part Number	Fig.	Dimensions			Weight (g)
				L (mm)	A (mm)	Hex (mm)	
-	6	EA0079767	3	55	-	-	10
-	7	EA0079778	3	55	-	-	13
-	8	EA0079789	3	55	-	-	14
-	9	EA0079790	3	55	-	-	16
-	10	EA0079701	3	55	-	-	19
-	12	EA0079712	3	55	-	-	24
-	16	EA0079716	3	78	-	-	50
-	19	EA0079719	3	88	-	-	81

FLOCS
(Fast Lube Oil Change System)



Table of Contents

FD14 Series.....	243
FLOCS	254

FD14 Series Oil Drain Coupling

FLOCS application

Danfoss' FD14 Drain Coupling is designed to serve as a drain port for use with Danfoss' FLOCS (Fast Lube Oil Change System) as well as providing a purging port for use during pre-fill operations. The FD14 provides a leak free push to connect operation for improving speed and efficiency for oil evacuation systems.



Product Features

- Low-Profile design with multiple sealing mechanisms
- Push-To-Connect socket/female half for easy one-hand operation
- Broad range of standard thread styles for plug/male half
- Utilizes a Copper-Crush gasket to seat against the port face
- Standard plug/male half seal material: FKM
- Standard socket/female half seal material: Buna-N
- Standard body material: High resistance carbon steel with zinc trivalent plating with zinc die-cast valve

Physical Characteristics

Body Size (in)	Max. Operating Pressure		Min. Burst Pressure Connected		Vacuum Connected Only	Rated Flow	
	(bar)	(psi)	(bar)	(psi)	(in./Hg)	(lpm)	(gpm)
3/8	3.5	50	7.0	200	28	12	3

Applications & Markets

- Automated oil evacuation systems
- Gravity drain oil evacuation systems

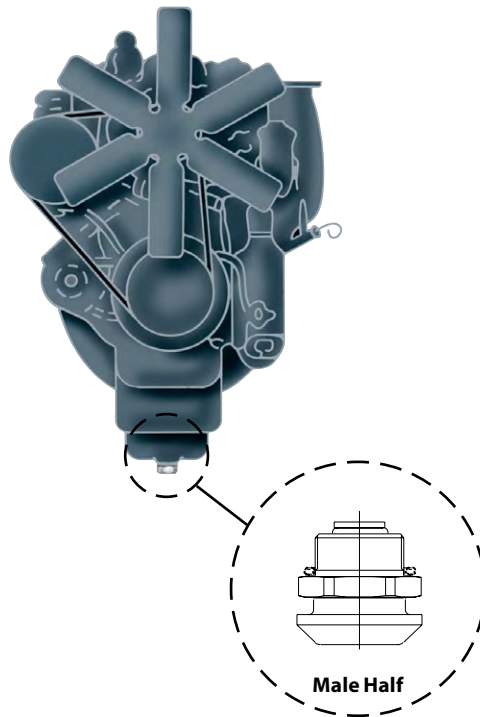

FD14 Series Oil Drain Coupling

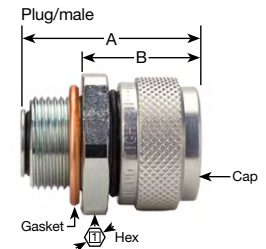

Figure 1

Dimensions (English Thread)

Body Size	Thread Size	Fig.	Dimensions				Hex ①		Min. Assy. Torque		Part Number Assembly (includes Gasket & Cap)	Gasket (Copper-Crush)	Cap (Brass)
			A	B					N-m	(lbs-ft)			
	P		mm	(in)	mm	(in)	mm	(in)					
3/8	1 1/16-12 UN-2A	1	39.1	(1.54)	24.4	(.96)	38.1	(1 1/2)	41-81	(30-60)*	FD14-4002-20-06	FD14-1206-08	FD14-1210-06
3/8	1 1/4-18 UNEF-2A	1	39.1	(1.54)	24.4	(.96)	38.1	(1 1/2)	41-81	(30-60)*	FD14-4002-05-06	FD14-1206-11	FD14-1210-06
3/8	1 1/8-12 UNF-2A	1	39.1	(1.54)	24.4	(.96)	38.1	(1 1/2)	41-81	(30-60)*	FD14-4002-14-06	FD14-1206-09	FD14-1210-06
3/8	1/2-14 DRYSEAL NPTF	1	40.6	(1.60)	24.4	(.96)	27.0	(1 1/16)	-	-	FD14-4002-27-06*	None Needed	FD14-1210-06
3/8	1/2-14 UNS-2A	1	38.6	(1.52)	24.4	(.96)	27.0	(1 1/16)	27-33	(20-24)*	FD14-4002-22-06*	FD14-1206-01	FD14-1210-06
3/8	1/2-20 UNF-2A	1	38.6	(1.52)	24.4	(.96)	27.0	(1 1/16)	27-33	(20-24)*	FD14-4002-01-06*	FD14-1206-01	FD14-1210-06
3/8	1-18 UNS-2A	1	39.1	(1.54)	24.4	(.96)	31.8	(1 1/4)	41-81	(30-60)*	FD14-4002-06-06	FD14-1206-07	FD14-1210-06
3/8	3/4-14 DRYSEAL NPTF	1	43.8	(1.72)	24.4	(.96)	31.8	(1 1/4)	-	-	FD14-4002-26-06	None Needed	FD14-1210-06
3/8	3/4-16 UNF-2A	1	39.1	(1.54)	24.4	(.96)	31.8	(1 1/4)	41-68	(30-50)*	FD14-4002-09-06	FD14-1206-04	FD14-1210-06
3/8	5/8-18 UNF-2A	1	38.6	(1.52)	24.4	(.96)	27.0	(1 1/16)	27-54	(20-40)*	FD14-4002-08-06*	FD14-1206-03	FD14-1210-06
3/8	7/8-14 UNF-2A	1	39.1	(1.54)	24.4	(.96)	31.8	(1 1/4)	41-81	(30-60)*	FD14-4002-10-06	FD14-1206-06	FD14-1210-06
3/8	7/8-18 UNS-2A	1	39.1	(1.54)	24.4	(.96)	31.8	(1 1/4)	41-81	(30-60)*	FD14-4002-07-06	FD14-1206-06	FD14-1210-06
3/8	9/16-18 UNF-2A	1	38.6	(1.52)	24.4	(.96)	27.0	(1 1/16)	27-54	(20-40)*	FD14-4002-12-06*	FD14-1206-02	FD14-1210-06

*⚠CAUTION: Failure to meet minimum assembly torque could result in fluid leakage.

Dimensions (English Thread)

Body Size	Thread Size	Fig.	Dimensions				Hex ①		Min. Assy. Torque		Part Number Assembly (includes Gasket & Cap)	Gasket (Copper-Crush)	Cap (Brass)
			A	B					N-m	(lbs-ft)			
	P		mm	(in)	mm	(in)	mm	(in)					
3/8	M12 X 1.5 6g	1	38.6	(1.52)	24.4	(.96)	27.0	(1 1/16)	27-33	(20-24)*	FD14-4002-23-06*	FD14-1206-01	FD14-1210-06
3/8	M12 X 1.75 6g	1	38.6	(1.52)	24.4	(.96)	27.0	(1 1/16)	27-33	(20-24)*	FD14-4002-25-06*	FD14-1206-01	FD14-1210-06
3/8	M14 X 1.25 6g	1	38.6	(1.52)	24.4	(.96)	27.0	(1 1/16)	27-33	(20-24)*	FD14-4002-03-06*	FD14-1206-02	FD14-1210-06
3/8	M14 X 1.5 6g	1	38.6	(1.52)	24.4	(.96)	27.0	(1 1/16)	27-33	(20-24)*	FD14-4002-24-06*	FD14-1206-02	FD14-1210-06
3/8	M18 X 1.5 6g	1	38.6	(1.52)	24.4	(.96)	31.8	(1 1/4)	27-33	(20-24)*	FD14-4002-02-06*	FD14-1206-04	FD14-1210-06
3/8	M20 X 1.5 6g	1	39.1	(1.54)	24.4	(.96)	31.8	(1 1/4)	41-81	(30-60)*	FD14-4002-16-06	FD14-1206-05	FD14-1210-06
3/8	M22 X 1.5 6g	1	39.1	(1.54)	24.4	(.96)	31.8	(1 1/4)	41-81	(30-60)*	FD14-4002-18-06	FD14-1206-06	FD14-1210-06
3/8	M24 X 1.5 6g	1	39.1	(1.54)	24.4	(.96)	31.8	(1 1/4)	41-81	(30-60)*	FD14-4002-19-06	FD14-1206-07	FD14-1210-06
3/8	M24 X 2 6g	1	39.1	(1.54)	24.4	(.96)	31.8	(1 1/4)	41-81	(30-60)*	FD14-4002-11-06	FD14-1206-07	FD14-1210-06
3/8	M25 X 1.5 6g	1	39.1	(1.54)	24.4	(.96)	31.8	(1 1/4)	41-81	(30-60)*	FD14-4002-17-06	FD14-1206-07	FD14-1210-06
3/8	M27 X 2 6g	1	36.3	(1.43)	24.4	(.96)	38.1	(1 1/2)	41-81	(30-60)*	FD14-4002-29-06	FD14-1206-06	FD14-1210-06
3/8	M30 X 1.5 6g	1	39.1	(1.54)	24.4	(.96)	38.1	(1 1/2)	41-81	(30-60)*	FD14-4002-21-06	FD14-1206-10	FD14-1210-06

*⚠CAUTION: Failure to meet minimum assembly torque could result in fluid leakage.

Dimensions (Socket/Female Half NPTF, Valved)

Body Size	Thread Size	Fig.	Dimensions				Hex ①		Part Number Assembly
			A	B					
	P		mm	(in)	mm	(in)	mm	(in)	
3/8	3/4-14 Dryseal NPTF	2	46.5	(1.83)	45.7	(1.80)	33.0	(1 5/16)	FD14-1001-12-06

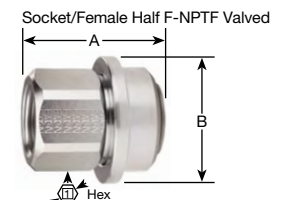

Figure 2

Dimensions (Socket/Female Half Assembly, Non-Valved)

Body Size	Hose Size	Fig.	Dimensions				Part Number Assembly
			A	B			
	P		mm	(in)	mm	(in)	
3/8	5/8"SOCKETLESS™	3	59.4	(2.34)	38.1	(1.50)	FD14-4003-10-06

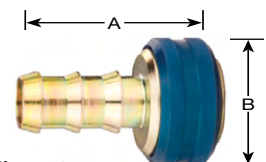

Figure 3

FD14 Series Oil Drain Coupling

Dimensions (Cap Molded Rubber)

Body Size	Fig.	Dimensions A		Dimensions B		Part Number Cap (Buna-N)
		mm	(in)	mm	(in)	
3/8	4	13.2	(.519)	35.6	(1.40)	FD14-1204-06

Dimensions (Cap)

Body Size	Fig.	Dimensions A		Dimensions B		Part Number Cap (Buna-N)
		mm	(in)	mm	(in)	
3/8	5	18.4	(.726)	31.8	(1.25)	FD14-1210-06

Swivel Joint

Body Size	Fig.	Thread Size	Cap	Part Number (Buna-N)
3/8	6	3/4-14	Dryseal NPTF	FD14-1004-12-12

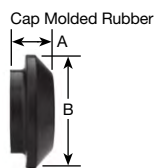

Figure 4

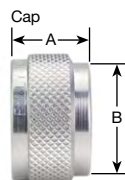

Figure 5

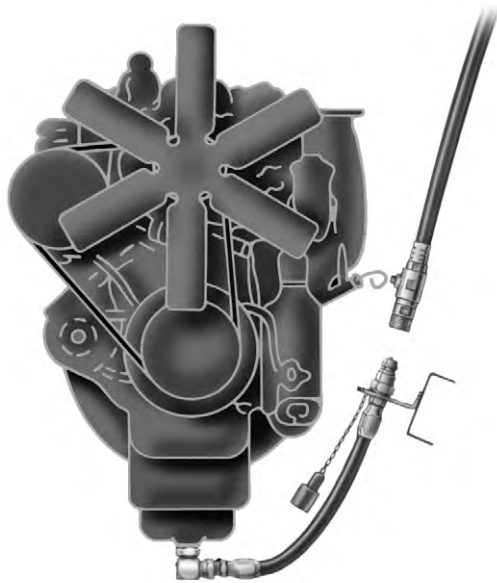

Figure 6

Access Methods

Remote Access

The FLOCS Remote Access Conversion Kit replaces the old drain plug with a 90 degree pan adapter, hose assembly and quick-disconnect coupling.



Installation:

1. Remove old drain plug.
2. Replace with the proper size FF1187 pan adapter.
3. Install mounting bracket (and optional 90° adapter).
4. Attach hose assembly to FF1187 pan adapter and mounting bracket.
5. Attach coupling and dust cap.

Your installation is now complete.

Evacuation:

When it is time to change the oil:

1. Remove the dust cap.
2. Connect the evacuation hose to the quick-disconnect coupling.
3. Activate the pump, and the used oil is quickly evacuated to storage tanks.
4. Disconnect the evacuation hose and replace the dust cap.

Direct Access

The FLOCS Direct Access Conversion Kit uses the Danfoss-developed FD14 Drain Coupling as an alternative to the standard remote hose kit. This coupling design permits easy, one-hand connection and disconnection of the evacuation unit's hose.

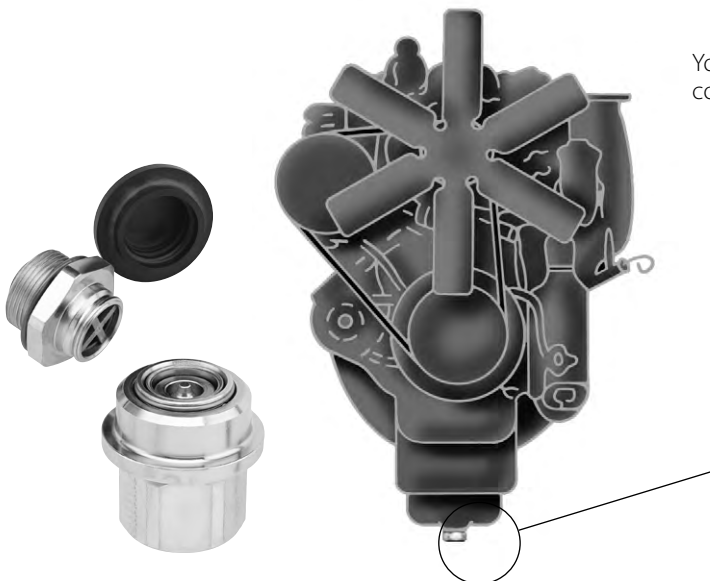

Installation:

1. Remove old drain plug.
2. Replace with the proper size FD14 Drain Coupling.
3. Install protective cap.

Your installation is now complete.

Evacuation:

When it is time to change the oil:

1. Remove the protective cap.
2. Connect the evacuation hose to the FD14 Drain Coupling.
3. Activate the pump, and the used oil is quickly evacuated to storage tanks.
4. Disconnect the evacuation hose and replace the protective cap.

Evacuation Systems

FLOCS 30A Air-powered Unit

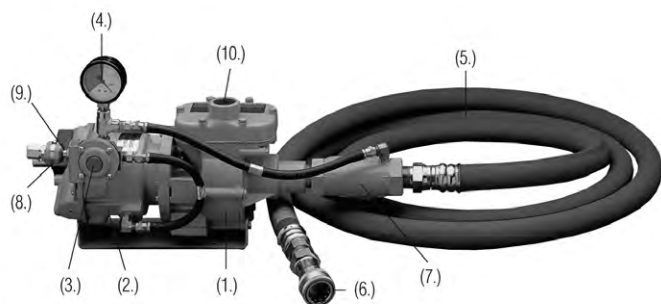

- | | |
|--|-----------------------------|
| 1. Piston pump | 6. Coupling half** |
| 2. 5 cfm air-operated motor (80-150 psi) | 7. Suction strainer |
| 3. Override button | 8. 1/4" air-supply coupling |
| 4. Cycle gauge | 9. 1/4" air-supply nipple |
| 5. 15' of 1" I.D. suction hose* | 10. 1" NPT discharge port |

(Part No. FF9330A-01) Remote Access (Part No. FF9330A-19) Direct Access

The FLOCS 30A Oil-evacuation Unit is a versatile, air-powered unit designed to be used where an air-power source is available, and electrical units may present a fire hazard. The unit can be adapted for use either on a lube truck or in a maintenance bay.

A FLOCS 30A unit can be used with equal effectiveness on vehicles with small oil-pan capacities (taxicabs, delivery trucks, school buses, etc.), medium capacities (highway equipment, tree-harvesting equipment, etc.) or large capacities (mining or construction equipment, etc.). Speed, ease of operation and versatility make the FLOCS 30A the best rapid oil-evacuation unit for many applications.

* FLOCS 30A Oil-evacuation Unit with 25' hose assembly is ordered by part number FF9330A-100 (Remote Access), FF9330A-20 (Direct Access).

** Differs with access method.

FLOCS 15 Electric-powered Unit

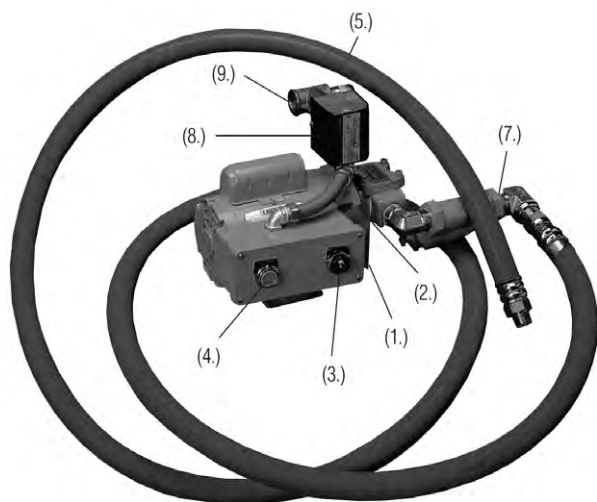

- | | |
|--|--|
| 1. 3/4" hp electric motor, 115V AC, 20 amp | 6. Coupling half** |
| 2. Gear pump | 7. Suction strainer |
| 3. Cycle-run starter button | 8. 115V AC flow-control switch |
| 4. Cycle-run signal light | 9. Backflow check valve with a 3/4" NPT discharge port |
| 5. 15' of 1" I.D. suction hose* | |

(Part NO. FF9315-01) Remote Access (Part No. FF9315-28) Direct Access

The FLOCS 15 Oil-evacuation Unit is electric powered and is designed for use in fleet maintenance service bays. Used in conjunction with overhead oil-dispensing reels, the FLOCS 15 speeds oil changes in large fleets. In some multilane maintenance shops, the FLOCS 15 concept has been used to implement a "fast-lane" operation, with one lane set aside for high-frequency, routine maintenance functions, leaving the other lanes free for more complex and time-consuming operations.

The FLOCS 15 is compatible with existing oil service equipment and can be installed quickly, without interrupting normal maintenance operations. It discharges old oil into existing storage tanks and shuts off automatically when the old oil has been evacuated. A signal light goes off when the evacuation is complete.

* FLOCS 15 Oil-evacuation Unit with 30' hose assembly is ordered by part number FF9516-01 (Remote Access), FF9516-02 (Direct Access).

** Differs with access method.

Remote Access (Aeroquip) Conversion Kits

Standard Vehicles

All kits are designed to accommodate manual drain when necessary.

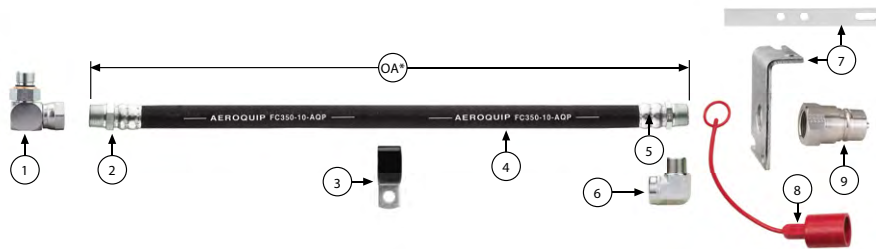

These components are common to each kit regardless of the part number.

Item #	Part #	Description
Item # 2	4412-8-10S	Hose Fitting (Reusable)
Item # 2	FJ3152-0810S	Hose Fitting (Crimp)
Item # 3	900729-6	Hose Clamp
Item # 4	FC350-10	Hose
Item # 5	4412-12-10S	Hose Fitting
Item # 5	FJ3152-1210S	Crimp
Item # 6	2089-12-12S	Connection At Mounting Flange
Item # 7	FF9363-01S	Bracket
Item # 8	5657-12	Dust Cap
Item # 9	5602-12-12S	Coupling Half

Kit Numbers are selected by matching the drain port thread size with the oil pan adapter of the same thread.

Thread Size	#1 Oil Pan Adapter & Gasket	Hardware Kit (Includes Items 1, 3, 6, 7, 8, & 9)	Assembled Kit* (Includes Items 1 through 9)
1/2 - 20	FF1187-0801S	FF428	FF400-OA
m 18 x 1.5	FF1187-0802S	FF429	FF401-OA
m 14 x 1.25	FF1187-0803S	FF430	FF402-OA
m 10 x 1	FF1187-0804S	FF431	FF403-OA
1 1/4 - 18	FF1187-0805S	FF432	FF404-OA
1 - 18	FF1187-0806S	FF433	FF405-OA
7/8 - 18	FF1187-0807S	FF434	FF406-OA
5/8 - 18	FF1187-0808S	FF435	FF407-OA
3/4 - 16	FF1187-0809S	FF436	FF408-OA
7/8 - 14	FF1187-08010S	FF437	FF409-OA
9/16 - 18UNF - 2A	FF1187-08012S	FF11042	FF11041-OA
1 1/8 - 12UNF - 2A	FF1187-08014S	FF11301	FF10452-OA
1 1/8 - 12UNF - 2A	**FF1187-08015S	FF11303	FF11302-OA
m 20 x 1.5	FF1187-0816S	FF11499	FF11498-OA
m 25 x 1.5	FF1187-0817S	FF11826	FF11825-OA
3/8 - 18 NPT (Pipe)	2047-8-6S	FF439	FF411-OA
1/2 - 14 NPT (Pipe)	2047-8-8S	FF440	FF412-OA
3/4 - 14 NPT (Pipe)	2047-8-12S	FF441	FF413-OA

* OA indicates overall length of hose assembly in inches. (Available to Aeroquip only.)

** Long Drop Version for oil pans covered by sound attenuation shields.

Large-capacity Vehicle Kit

All kits are designed to accommodate manual drain when necessary.

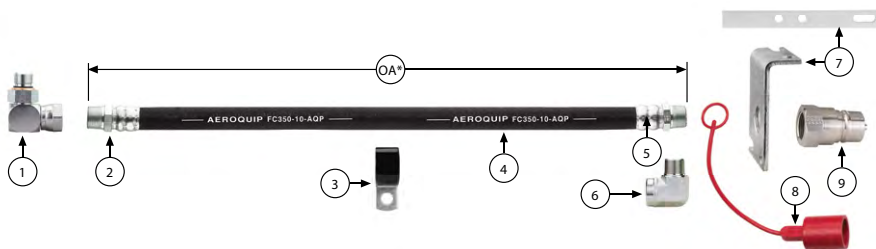

These components are common to each kit regardless of the part number.

Item #	Part #	Description
Item # 2	4412-8-12S FJ3152-0812S	(Reusable) (Crimp)
Item # 3	900729-8	Hose Clamp
Item # 4	FC350-10	Hose
Item # 5	4412-12-12S	Hose Fitting
Item # 5	FJ3152-1212S	(Crimp)
Item # 6	2089-12-12S	Connection At Mounting Flange
Item # 7	FF9363-01S/ FF9270-01S	Bracket
Item # 8	5657-12	Dust Cap
Item # 9	5602-12-12S	Coupling Half

Kit Part Numbers are selected by choosing the appropriate drain port thread size.

Items Thread Size	#1 Oil Pan Adapter & Gasket	#2 Hose Fitting	Hardware Kit (Includes Items 1, 3, 6, 7, 8, & 9)	Assembled Kit* (Includes Items 1 through 9)
3/4 - 14 NPT (Pipe)	2047-8-12S	4412-8-12S	FF943	FF293-OA
3/8 - 18 NPT (Pipe)	2047-8-6S	44112-8-12S	FF945	FF322-OA
7/8 - 18	FF1187-0807S	4412-8-12S	FF944	FF317-OA
7/8 - 14	FF1187-0810S	4412-8-12S	FF946	FF380-OA
1 - 18	FF1187-0806S	4412-8-12S	FF947	FF395-OA
1 - 11 1/2 NPT (Pipe)	2024-16-12S	4411-8-12S	FF948	FF833-OA
1/2 - 14 NPT (Pipe)	2024-8-12S	4411-8-12S	FF949	FF834-OA

* OA indicates overall length of hose assembly in inches. (Available to Aeroquip only.)

Remote Access (Weatherhead) Conversion Kits

Standard Vehicles

All kits are designed to accommodate manual drain when necessary.

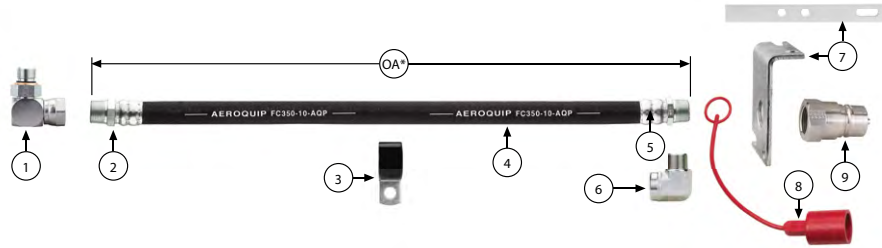

These components are common to each kit regardless of the part number.

Item #	Part #	Description
Item # 2	0A10E-108	Hose Fitting
Item # 3	900729-6	Hose Clamp
Item # 4	H56910	Hose
Item # 5	069	Hose Fitting Adapter for 90
Item # 6	2089-12-12S	Connection At Mounting Flange
Item # 7	FF9363-01S	Bracket
Item # 8	5657-12	Dust Cap
Item # 9	5602-12-12S	Coupling Half

Kit Numbers are selected by matching the drain port thread size with the oil pan adapter of the same thread.

Thread Size	#1 Oil Pan Adapter & Gasket	Hardware Kit (Includes Items 1, 3, 6, 7, 8, & 9)
1/2 - 20	FF1187-0801S	FF428
m 18 x 1.5	FF1187-0802S	FF429
m 14 x 1.25	FF1187-0803S	FF430
m 10 x 1	FF1187-0804S	FF431
1 1/4 - 18	FF1187-0805S	FF432
1 - 18	FF1187-0806S	FF433
7/8 - 18	FF1187-0807S	FF434
5/8 - 18	FF1187-0808S	FF435
3/4 - 16	FF1187-0809S	FF436
7/8 - 14	FF1187-0810S	FF437
9/16 - 18UNF - 2A	FF1187-08012S	FF11042
1 1/8 - 12UNF - 2A	FF1187-08014S	FF11301
1 1/8 - 12UNF - 2A	**FF1187-08015S	FF11303
m 20 x 1.5	FF1187-0816S	FF11499
m 25 x 1.5	FF1187-0817S	FF11826
3/8 - 18 NPT (Pipe)	2047-8-6S	FF439
1/2 - 14 NPT (Pipe)	2047-8-8S	FF440
3/4 - 14 NPT (Pipe)	2047-8-12S	FF441

** Long Drop Version for oil pans covered by sound attenuation shields.

Large-capacity Vehicle Kit

All kits are designed to accommodate manual drain when necessary.

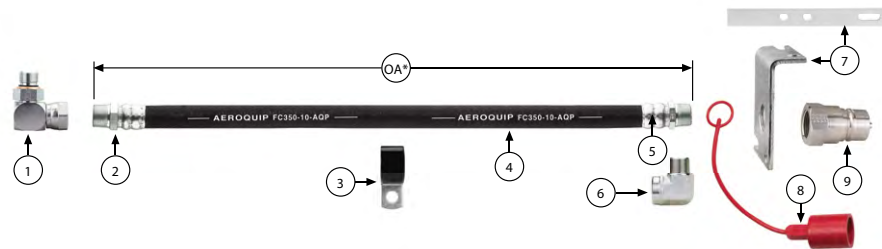

These components are common to each kit regardless of the part number.

Item #	Part #	Description
Item # 2	069	Hose Clamp
Item # 3	900729-8	Hose
Item # 4	H56912	Hose
Item # 5	069	Hose Fitting
Item # 6	2089-12-12S	Connection At Mounting Flange
Item # 7	FF9363-01S/ FF9270-01S	Bracket
Item # 8	5657-12	Dust Cap
Item # 9	5602-12-12S	Coupling Half

Kit Part Numbers are selected by choosing the appropriate drain port thread size.

Thread Size	#1 Oil Pan Adapter & Gasket	Hardware Kits (Includes Items 1, 3, 6, 7, 8, & 9)
3/4 - 14 NPT (Pipe)	2047-8-12S	FF943
3/8 - 18 NPT (Pipe)	2047-8-6S	FF945
7/8 - 18	FF1187-0807S	FF944
7/8 - 14	FF1187-0810S	FF946
1 - 18	FF1187-0806S	FF947
1 - 11 1/2 NPT (Pipe)	2047-8-16S	FF948
1/2 - 14 NPT (Pipe)	2047-8-8S	FF949

Oil Thief System



Providing easy access to oil samples for spectro-graphic analysis.

With the spectrographic analysis of engine oil being increasingly required, the problem of obtaining oil samples quickly, economically and efficiently has demanded more attention.

With the push of a button, an oil sample can be taken during the evacuation cycle of any FLOCS unit and collected in a standard sampling bottle for analysis. It takes less than 15 seconds to collect an oil sample with the Oil Thief.

Because oil-analysis facilities provide differing oil sample bottles, the FLOCS Oil Thief is available with a sample bottle port thread to match your needs. (Refer to the sample bottle thread sizes and corresponding Oil Thief part numbers listed in this chart.)

Physical Characteristics:

Buna-N Seals for -40 to +225 Degrees Fahrenheit Service. Vacuum Capable to 28" Hg.

In a typical FLOCS system, a Male NPTF-to-Male NPTF adapter (2083-12-12s) is used on one end of the Oil Thief to connect to the female quick-disconnect coupling.

Operating Instructions:

The Oil Thief is compatible with any FLOCS evacuation unit. Simply install an Oil Thief between the evacuation hose line and the coupling half; then attach a sample bottle. Wait a few seconds after starting the evacuation cycle (to flush away any oil from the last evacuation); then depress the sample collection button for approximately ten seconds. Release the button and remove the sample bottle. Clean the Oil Thief sample bottle port, attach another bottle and you are ready for the next sample.

Note: When not in use, the Oil Thief should have a spare sample bottle attached to maintain valve cleanliness.

Features:

- Push-button operation
- Light weight
- Repairable seals
- Accepts a wide variety of sample bottle threads

Benefits:

- No-mess oil sample
- Economical – one Oil Thief per maintenance bay evacuation pump
- Allows oil sampling while oil is still hot, without employee hazard

Oil Thief Part Number	Sample Bottle Thread Size (In Inches)
FF9300-75-0001	1.480-6 (or 38mm)
FF9300-75-0002	2.070-6
FF9300-75-0003*	1.580-6
FF9300-75-0004*	1.750-6 (or 45mm)

*Available by special order.

Remote Access Conversion Kit Installation

1. Selecting the Conversion Kit

Remove the oil pan drain plug and drain engine oil. Measure the thread on the pan plug with a thread gauge. The thread size will determine the specific conversion kit to be used. Kits are available in two styles: 1) assembly kits (contain mounting hardware and hose assembly), and 2) oil pan drain fitting and coupling with mounting bracket (installer must finish hose assembly). Hose length in inches ("L") is added to the basic part number when ordering assembled kits.

2. Installation

Determine the length of hose required for your vehicle. If the hose length is not known, mount the quick disconnect coupling and bracket and route the hose from the coupling bracket to the oil pan drain. Refer to step 5 for proper routing, mark and cut the hose to length. Following step 3 install the hose fittings to complete the hose assembly. Install the oil pan drain fitting (per step 6) and the hose assembly.

Pan Plug Thread Size	Assembled Kit No.	Hardware Kit No.
1/2-20	F400-L	FF428
18 x 1.5 mm	FF401-L	FF429
14 x 1.25 mm	FF402-L	FF430
10 x 1 mm	FF403-L	FF431
1 1/4-18	FF404-L	FF432
1-18	FF405-L	FF433
7/8 - 18	FF406-L	FF434
24 x 2 mm	FF410-L	FF438
9/16 - 18	FF952-L	FF453
3/8 - 18 NPT (Pipe)	FF411-L	FF439
1/2 - 14 NPT (Pipe)	FF412-L	FF440
3/4 - 14 NPT (Pipe)	FF413-L	FF441

3. Assembling the Hose Line

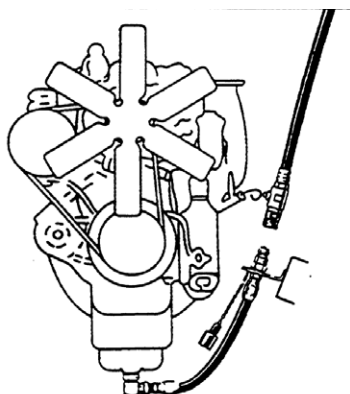

A. Put the socket in vise and screw hose into socket counterclockwise until it bottoms. Back off 1/4 turn.

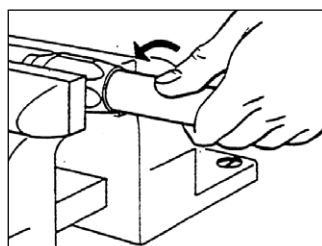

B. Oil nipple threads and inside of hose liberally. Use heavy lube oil.

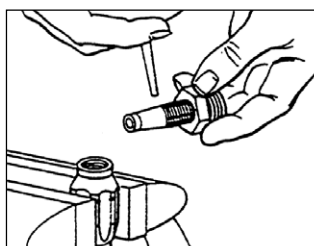

C. Screw nipple clockwise into socket and hose. Keep hose from turning while assembling nipple. Leave 1/32" to 1/16" clearance between nipple hex and socket.

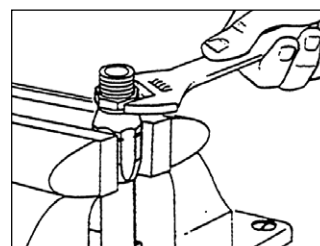

4. Mounting the Coupling

Note: The coupling bracket should be mounted so that the coupling valve is located above the oil level in the crank case. Make sure that the coupling is mounted firmly and located so that it will not be damaged during normal operation of the vehicle.

A. Attach mounting bracket to desired location on vehicle, preferably near the dipstick. Screw assembled fitting into bracket until enough thread is exposed on opposite side to assemble and tighten the quick disconnect coupling.

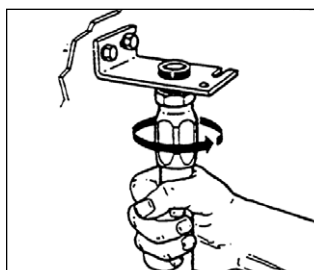

B. Assemble dust cap and coupling to mounted hose fitting. Use pipe thread sealant. Check for any leakage after kit is installed.

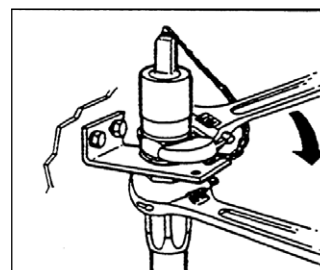

5. Routing the Hose

- A.** Avoid heat. If the hose must be routed past the manifold or exhaust pipe, use Firesleeve for heat protection.
- B.** Avoid sharp or abrasive edges. Use Danfoss protective coil/sleeve if hose might be cut or chafed or use support clamp provided to avoid abrasion.
- C.** Avoid kinking. Tight bends may kink hose. Observe bend radius limitations.

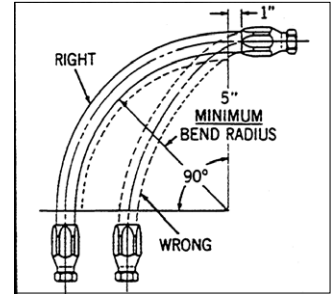
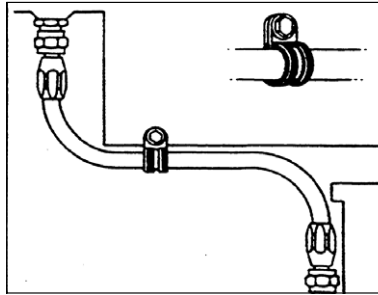
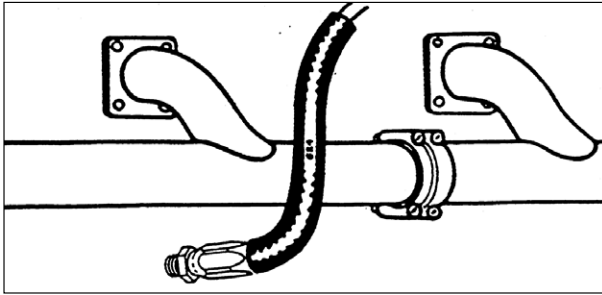

6. Installing the Oil Pan Drain Fitting

- Lubricate the O-ring seal on the Oil Pan Drain Fitting. Screw the fitting into the oil pan until the last thread on the upper set of threads is engaged.
- Position the elbow and tighten the jam nut (two wrenches needed). Screw the hose fitting into the elbow and tighten all connections.
- Oil may be manually drained by disconnecting the hose fitting from the oil pan adapter.

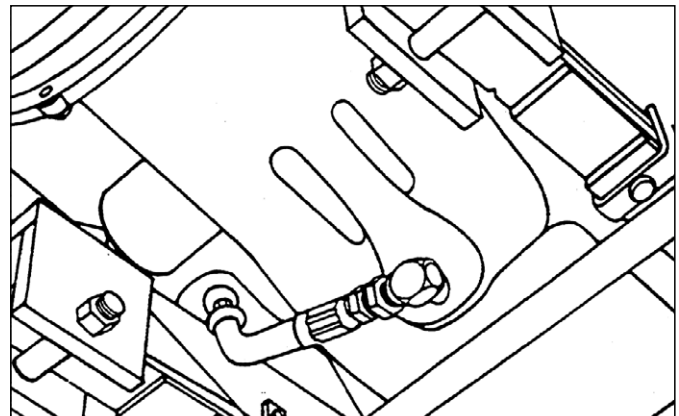
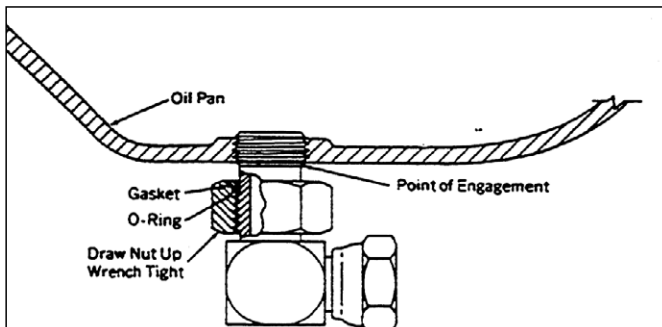

Air Units

Operation and Service Info

FLOCS 30A Air-powered Unit

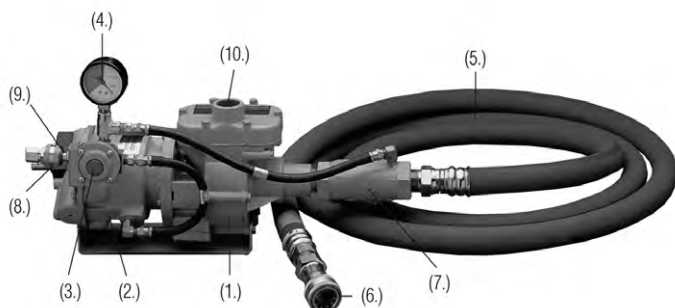

- | | |
|---|--|
| <ol style="list-style-type: none"> 1. Piston pump 2. 5 cfm air-operated motor (80-150 psi) 3. Override button 4. Cycle gauge 5. 15' of 1" I.D. suction hose* | <ol style="list-style-type: none"> 6. Coupling half** 7. Suction strainer 8. 1/4" air-supply coupling 9. 1/4" air-supply nipple 10. 1" NPT discharge port |
|---|--|

Specifications

- Maximum discharge pressure: 1/5 of the input air pressure (power source).
- Recommended operating temperature of fluid: +60°F. to 180°F.
- Strainer screen size: size 35 mesh.
- Flow rate: see flow chart.
- Pump power source: 80 to 150 psi air at 5 CFM minimum.
- Fluid handling compatibility: all petroleum base fluids below 6000 SSU
- Minimum discharge line: size 1" I.D. (-16).
- Mounting requirements:

Installation Instructions

Mount the unit for easy accessibility to the vehicles to be serviced. It may be mounted in either a horizontal or vertical position. A mounting bracket is provided for rigid mounting of the pump (reference Figure 3 for detail dimensions). The pump motor operates on 80-150 psi air at 5 CFM minimum. The unit is to be mounted so that the cycle gauge is in full view of the operator and the override button and strainer cleanout are readily accessible.

1. Connect the used oil discharge line to the 1" pipe port at the top of the unit. The discharge line must be no higher than 10 feet above FLOCS unit. It is important to keep the discharge line large to maintain maximum efficiency.

Use a 1" I.D. pipe for lines 15' to 30' long and a 1 1/4" I.D. pipe for lines 30' to 100' long. Make sure the discharge line does not develop more head pressure than 1/5 of the air pressure source. (Example: air power source of 150 psi, discharge head pressure of 30 psi maximum.)

2. Connect the air supply line into the 1/4" NPTF port of the quick disconnect coupling supplied with the unit. The air supply line should be equipped with an air line water filter to prevent water from contaminating the pump control and/or causing freezing-up. A lubricator is also recommended for the air supply line (use non-detergent oil in the lubricator).

Operation

The FLOCS 30A unit is a simple self-controlled automatic oil evacuator. Once it has been started it will operate until all the oil has been evacuated from the oil pan. The unit will stop automatically when air enters the suction hose.

This unit is controlled by a normally closed, air supply shut-off valve, which requires the pump vacuum to hold it open. At the end of the evacuation cycle air in the suction line destroys the vacuum causing the control valve to shut off the air pressure supply and stop the pump. The unit also incorporates a strainer to prevent large particles from damaging the pump.

To operate:

1. Attach the FLOCS 30A unit quick disconnect coupling to the mating conversion kit coupling half on the equipment.
2. Press the red override button to start the unit; hold for approximately 5 seconds. Cycle gauge will indicate run condition.
3. The unit will shut off automatically when all oil is evacuated. The cycle gauge will indicate when the unit is off. Disconnect the evacuation line.

- see Fig. 3, page 3.
- 15' of 1" I.D. suction line standard.
- 5601-12-12 female coupling.

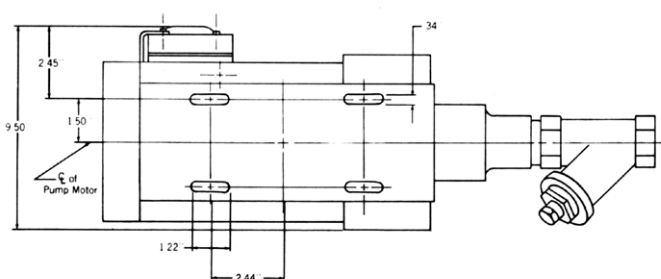

Figure 3

3. Install the 15' evacuation line by screwing the swivel hose fitting into the female thread on the strainer. Use pipe dope to insure a proper seal. Do not over tighten.

Note: The unit should not be mounted in a position requiring more than 10 feet of evacuation lift.

FLOCS 30A

Parts List and Assembly Drawing

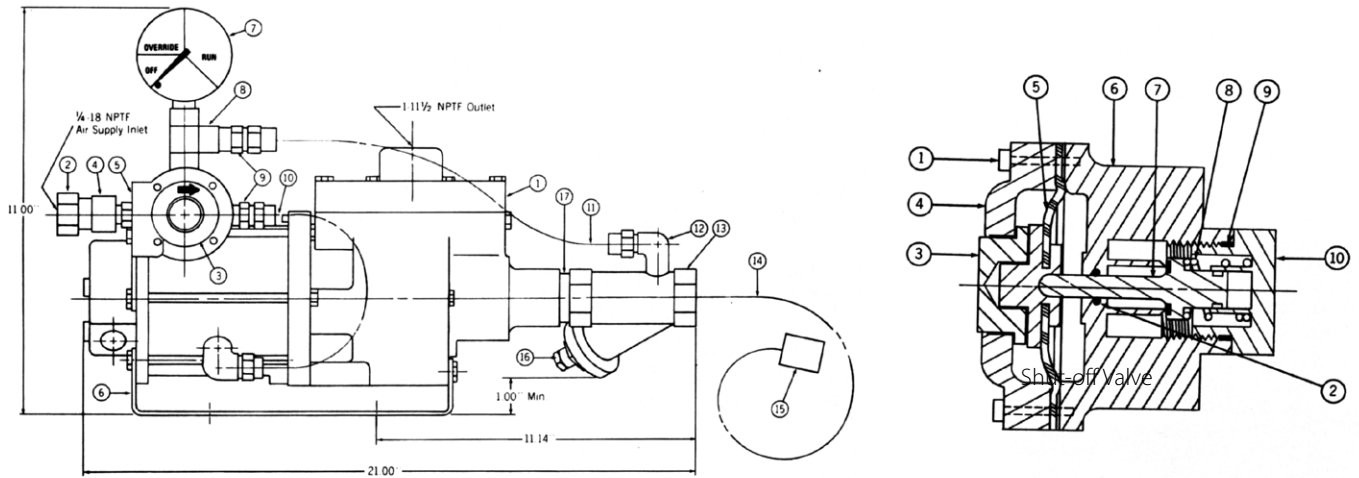

Item No.	Quality Required	Description	Part No.	Basic Material
1	1	Pump	FF9330A-02	Cast Aluminum
2	1	Coupling Half	FD40-1000-04-04	Steel
3	1	Shut-off Valve	FF9330A-03	Aluminum
4	1	Coupling Body	FD40-1014-04-04	Steel
5	1	Bracket	FF9330A-14	Steel
6	1	Bracket	FF9330A-13	Steel
7	1	Cycle Gauge	FF9330A-11	Steel
8	1	Service Tee	2092-4-4S	Steel
9	1	Adapter	2021-4-4B	Brass
10	2	Hose Assembly	255603-4B-8	Brass Fittings
11	1	Hose Assembly	255603-4B-13	Brass Fittings
12	2	Adapter	2024-4-4B	Brass
13	1	Strainer	FF9330A-12	Steel
14	1	Hose Assembly	FA1552KMM1800	Steel Fittings
15	1	Coupling Half	5501-12-12S	Steel
16	1	Pipe Plug	2082-12S	Steel
17	1	Adapter	2084-16S-11/2	Steel

Shut-Off Valve Parts List				
Item No.	Quality Required	Description	Part No.	Basic Material
1	4	Screw	FF9144-0110-12	Steel
2	1	O-ring	22550-008	Buna-N
3	1	Button	FF9330A-09	Aluminum
4	1	Cover	FF9330A-10	Aluminum
5	1	Diaphragm	FF9330A-08	Steel and Rubber
6	1	Valve Body	FF9330A-04	Cast Aluminum
7	1	Valve	FF9330A-05	Brass & Rubber
8	1	Spring	FF9330A-06	Spring Steel
9	1	O-ring	22550-018	Buna-N
10	1	Cap	FF9330A-07	Plastic

FLOCS 30A

Parts List and Assembly Drawing

Servicing Components

Instructions for Rebuilding Shut-Off valve (P/N FF9330A-03)

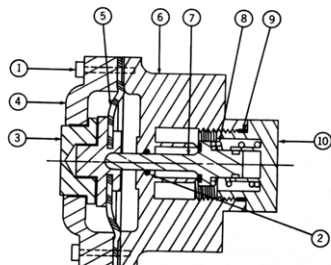

Figure 2

1. Remove the four cover screws, item #1; remove button, item #3; remove and replace diaphragm if necessary, item #5. For assembling, torque cover screws 25-30 in.-lbs.

2. Remove plastic cap, item #10; spring, item #8, and valve, item #7. Replace the O-ring seal, item #9, on the cap. Check the bonded seal on the valve, item #7; inspect for foreign particles or burrs and replace if necessary.

3. Replace O-ring seal, item #2, with a 22559-00B O-ring. Care must be taken not to scar the seal area upon removal of the O-ring.

4. Lubricate all seals with petroleum jelly prior to installation. Make sure all metal parts are clean and not damaged.

5. Assemble in reverse order.

Note: A complete shut-off valve is available as an assembly for replacement.

Order by Part Number FF9330A-03.

Servicing the Strainer

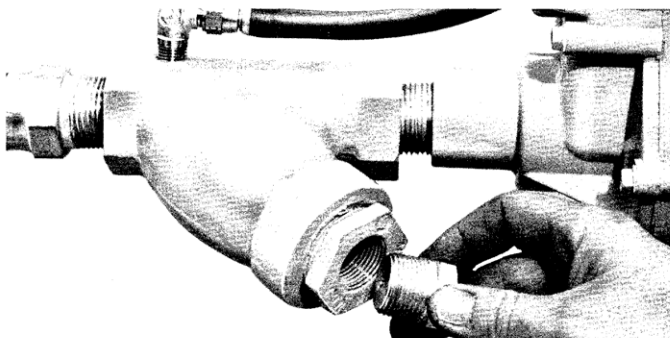

The strainer should be serviced daily under normal fleet operation conditions. If the strainer becomes clogged or partially blocked with residue, the evacuation operation will slow down due to lack of oil flow to the pump.

1. Remove the strainer clean-out plug and screen.
2. Wash the plug and screen with clean fuel oil.

3. Replace the plug and screen. Tighten wrench-tight.

4. Be careful not to crack the castings or pipe bushings when reassembling the plug. Cracked and/or leaking castings will result in insufficient pumping.

Troubleshooting the FLOCS 30A

Problem

Unit will not run when override button is pushed.

Correction

- (A) Check the air supply line to see if it is connected and the air is turned on.

Problem

Unit will not continue running after the button is released.

Correction

- (A) Button was not in override long enough; hold override button until cycle gauge indicates run.

(B) Check for vacuum leakage at strainer suction line, vehicle kit and/or hose fittings on control regulator.

(C) Check air pressure and CFM to make sure that the minimum 80 psi and 5 CFM are available to pump.

(D) Check the strainer for contamination.

(E) Check regulator for damaged seals or diaphragm. Reference Figure 5, page 6 for servicing.

(F) Check oil dipstick; oil pan may be empty.

Problem

Unit shuts off before all oil is evacuated.

Correction

- (A) Check all threaded connections in suction line for vacuum leakage. Mount vacuum gauge in mating coupling half. Plug into end of suction line. Run pump to get a vacuum. Watch gauge. A sudden loss of vacuum indicates a suction leak.

Problem

Unit will not shut off after all the oil has been evacuated.

Correction

- (A) Check for plugged coupling at vehicle kit.
- (B) Check regulator for damaged seals or diaphragm. Reference Figure 5, page 6 for servicing.

Problem

Cycle gauge will not indicate the mode the pump is in.

Correction

- (A) Check gauge to see if indicator hand is loose.
- (B) Check for any leaks in thread and hose fitting connections.

FLOCS 30A UNIT EVACUATION RATES

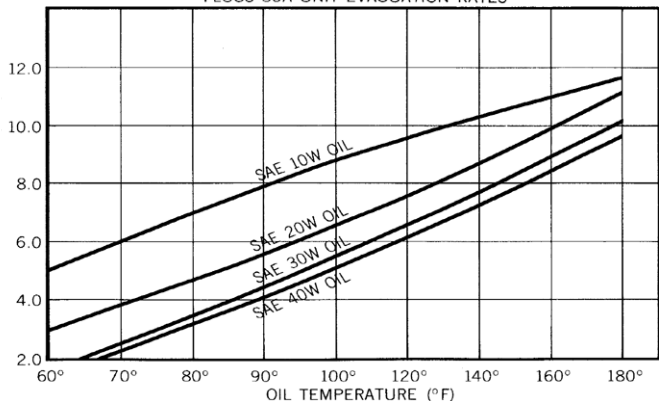

Electric Units

Operation and Service Info

FLOCS 15

Electric-powered Unit

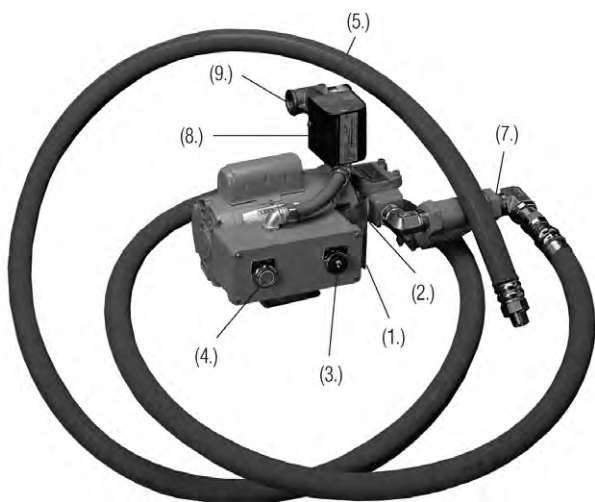

Specifications

- Maximum discharge pressure-50 psi
- Maximum fluid lift-10ft

- Operating temperature (of fluid) +20°F. to +180°F.
- Strainer screen size-35 mesh
- Flow rate-see flow chart on back cover

Installation Instructions

Mount the unit for easy accessibility to vehicles to be serviced. The pump motor operates on 115V AC 20 AMP. To install unit:

1. Remove cover plate from the control panel.
2. Drill an access hole on the side or the bottom of the control box (3/4" hole recommended for conduit). Run service wiring through access hole.

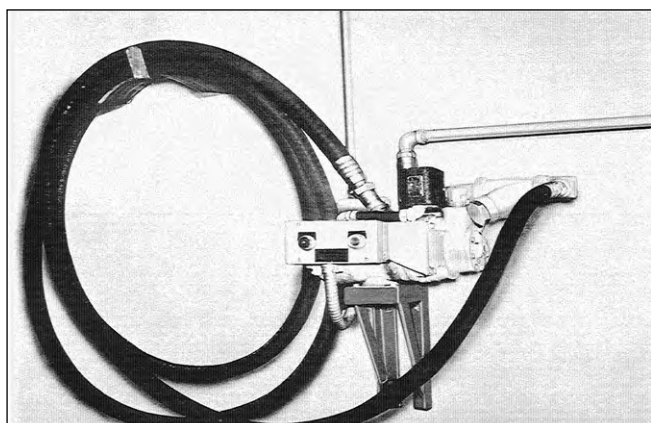

1. 3/4 hp electric motor, 115V AC, 20 amp
2. Gear pump
3. Cycle-run starter button
4. Cycle-run signal light
5. 15' of 1" I.D. suction hose*
6. Coupling half**
7. Suction strainer
8. 115V AC flow-control switch
9. Backflow check valve with a 3/4" NPT discharge port

The FLOCS 15 is a simple, almost totally automatic machine.

To operate:

1. Attach the suction line coupling half to the FLOCS coupling half on the vehicle. To connect the coupling, retract the knurled sleeve, push the coupling halves together and release the sleeve.
2. Press the cycle start button to start the unit. The cycle run light will come on.
3. The unit will shut off automatically when all oil is evacuated. The signal light will shut off. Disconnect the evacuation line.

- Motor electrical rating-115V, 60CY., 20 APM AC
- Fluid handling compatibility-all petroleum base fluids below 6000 SSU

- Minimum discharge line 3/4" I.D.
- Mounting requirements-per NEMA 56 C Frame

3. Connect a service grounding wire to one of the two bracket bolts on the side of the control box.
4. Connect the live wire to the 6" black lead.
5. Connect the neutral wire to the 6" white lead.
6. Tighten conduit or cord connector in 3/4" access hole.
7. Replace control panel and tighten in place.
8. Connect the old oil discharge line to the 3/4" NPT port on the check valve. NOTE: the check valve can be swung up or down for more direct routing.
9. Install the 15' evacuation line by screwing the swivel hose fitting into the female NPT thread on the strainer adapter (a 90° adapter is available to suit installation). Caution: Do not over tighten pipe threads into strainer. The use of pipe sealant is recommended.
10. The timing relay (in the control box) is factory set for 25 seconds. The purpose of the timing relay is to keep the pump engaged until the initial flow of oil reaches the pump from the vehicle. For instructions on adjustment of the timing relay, see page 6.

Note: The unit should not be mounted more the 10 ft. above floor level to allow no more than 10 ft. of evacuation height. The discharge line should be plumbed so as not to cause more than 50 psi head pressure.

FLOCS 15

Parts List and Assembly Drawing

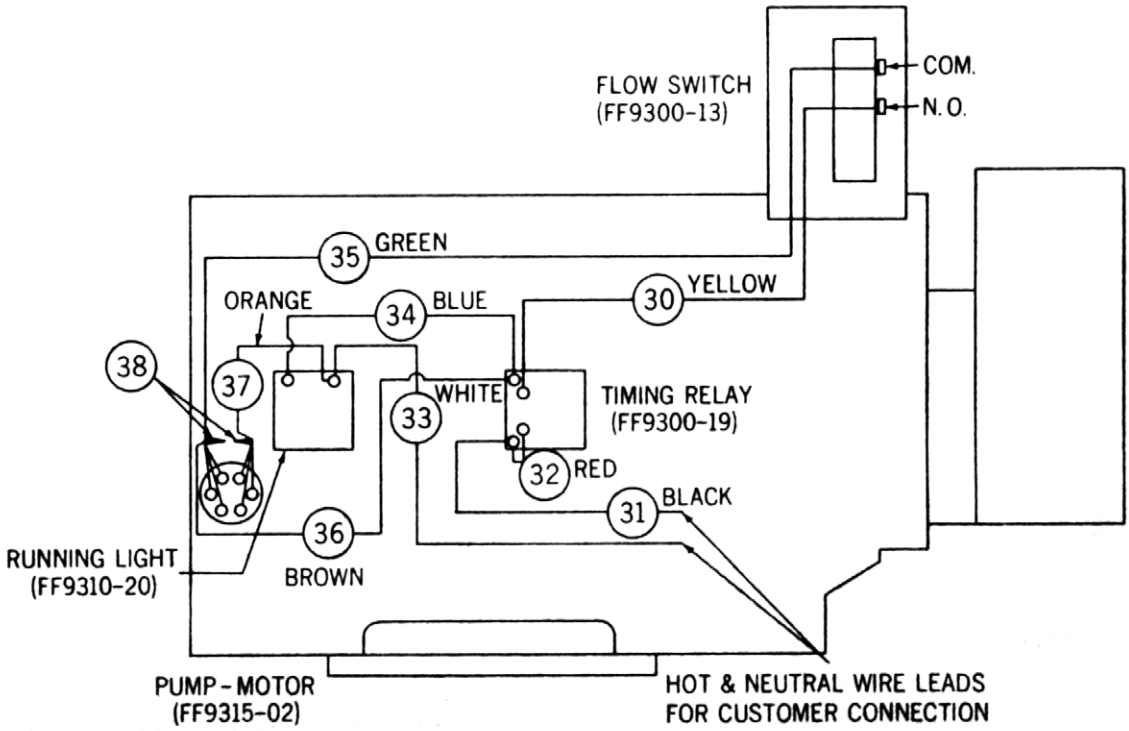
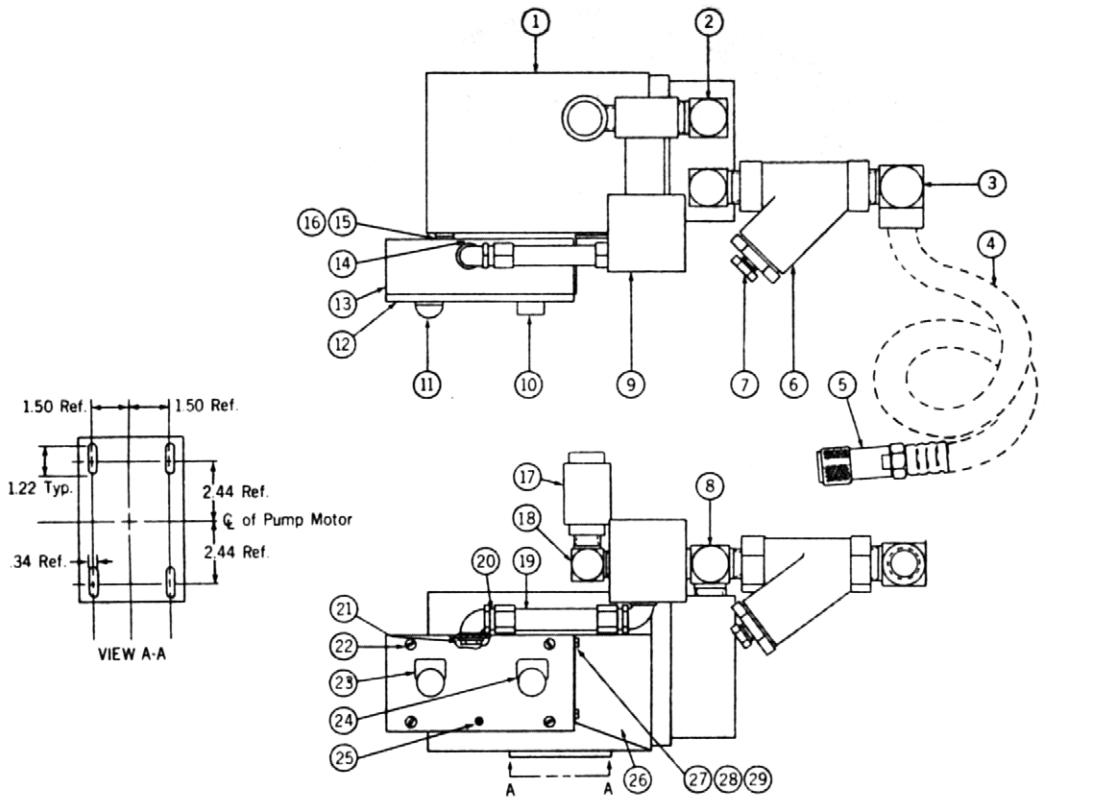

WIRING DIAGRAM

FLOCS 15

Parts List and Assembly Drawing

Item Number	Quantity Required	Description	Part Number	Basic Material
1	1	Pump Motor	FF9315-02	Steel
2	1	Adapter	2085-16-12S	Steel
3	1	Adapter	2089-16-16S	Steel
4	1	Hose Assembly	FA1552KMM1800	Steel
5	1	Coupling Half	5601-12-12S	Steel
6	1	Strainer	FF9315-03	Steel
7	1	Pipe Plug	2082-12S	Steel
8	1	Adapter	2085-16-16S	Steel
9	1	Flow Switch	FF9300-13	Steel
10	1	Timing Relay	FF9300-19	Steel
11	1	Running Light	FF9310-20	Steel
12	1	Cover	FF9315-20	Steel
13	1	Control Box	FF9315-05	Steel
14	1	Decal	FF9315-10	-
15	1	Conduit Nipple	FF9315-18	Steel
16	2	Lock Nut	FF9315-19	Steel
17	1	Check Valve	FF9315-24	Brass
18	1	Adapter	2085-12-12S	Steel
19	1	Conduit	FF9315-23	Steel & PVC
20	2	90° Angle Connector	FF9315-22	Steel
21	3	Reducing Washer	FF9315-21	Steel
22	4	Screw	210002-1-8-7S	Steel
23	1	Legend Plate	FF9315-07	Steel
24	1	Legend Plate	FF9315-06	Steel
25	1	Decal	FF9315-09	-
26	1	Bracket	FF9315-08	Steel
27	2	Bolt	FF9309-0110-04S	Steel
28	2	Lock Washer	210104-1-10S	Steel
29	2	Nut	FF9236-0110S	Steel
30	1	Wire Assembly	FF9315-11	Copper & Vinyl
31	1	Wire Assembly	FF9315-17	Copper & Vinyl
32	1	Wire Assembly	FF9300-30	Copper & Vinyl
33	1	Wire Assembly	FF9315-16	Copper & Vinyl
34	1	Wire Assembly	FF9315-13	Copper & Vinyl
35	1	Wire Assembly	FF9315-12	Copper & Vinyl
36	1	Wire Assembly	FF9315-25	Copper & Vinyl
37	1	Wire Assembly	FF9315-15	Copper & Vinyl
38	2	Wire Connector	FF9310-38	Steel & Plastic

Servicing Components

Servicing Components

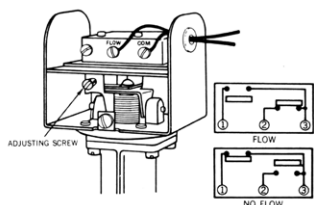

Instructions on adjustments of the flow switch:

1. Remove the black switch cover by loosening the two screws on the side and pull off the cover.

2. If a small amount of oil remains in the crankcase after the pump shuts off, the adjusting screw should be turned counterclockwise to decrease the sensitivity of the switch. DO NOT remove the screw completely or back it out so far as to cause interference with the replacement of the cover.

3. If the pump stays on when no oil is flowing, the adjusting screw should be turned clockwise until the pump shuts off.

Instructions on adjustment of the time delay-relay switch:

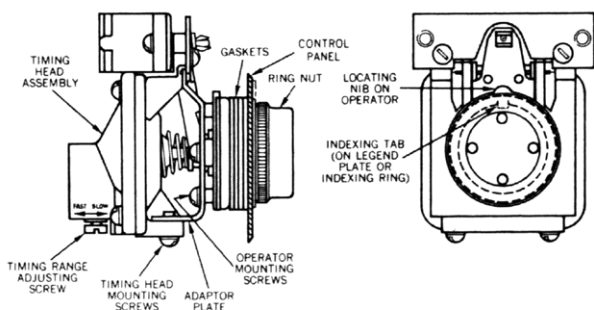

1. The timing relay is factory pre-set for a normal time delay on most applications (approximately 25 seconds).

2. To increase the time setting, turn the adjusting screw clockwise.

3. To decrease the time setting, turn the adjusting screw counterclockwise. A fraction of a turn will add or subtract 10-15 seconds of time.

Servicing Components

Servicing the Strainer:

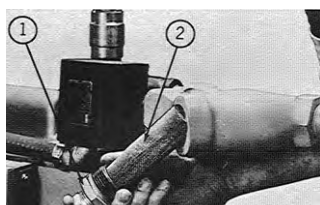

The strainer should be serviced daily under normal operating conditions. If the strainer becomes clogged or partially blocked with engine residue, the evacuation operation will slow down due to lack of oil flow to the pump.

1. Remove the strainer clean out plug (Figure 7-1), and pull the screen (Figure 7-2) out.

2. Wash the plug and screen in clean fuel oil.

3. Place screen in plug counter bore and replace assembly in strainer housing. Tightening plug wrench tight. Use of pipe thread sealant is recommended.

Figure 5

Troubleshooting

Problem:

Unit operates approximately 25 seconds, then shuts off before all of the oil is out of the vehicle engine.

Correction:

- (a) Oil may have too heavy viscosity due to a heavy weight oil or cold oil. The engine of the vehicle should be started and run to heat the oil to above 70°F, or set the time delay switch to hold the pump engaged longer than the standard 25 seconds factory setting. See time delay switch adjustment (Figure 6).
- (b) Strainer screen may be plugged with foreign material. Clean strainer screen in diesel fuel (Figure 7).
- (c) The FLOCS unit may be trying to lift oil from too low a level. 10 feet lift is maximum. Move the FLOCS unit closer to the vehicle oil pan level.
- (d) Hose connections may not be right at the vehicle pan plug. Check and tighten hose to plug union connection.

Problem:

Unit doesn't go into the evacuation cycle when "cycle run" button is pushed.

Correction:

- (a) Check wiring to be sure there are no broken or disconnected wires.
- (b) Check fuse on the power line to be sure power is being supplied to the unit.

Problem:

Evacuation is not fully completed when unit shuts off.

Correction:

- (a) Flow switch may be set too high and be too sensitive to the lower stream of oil near the completion of evacuation. Adjust flow switch (Figure 5)
- (b) Broad flat oil pans with drain connection coming out the side instead of the bottom can cause air to enter into the drain line causing premature shut off. Run a second cycle by resetting the cycle start button.
- (c) Cold oil in the oil pan can cause slow drain down of the oil pan and allow the FLOCS unit to shut off prematurely. Start vehicle engine and warm oil above 70°F, before evacuating.

Flow Rate Chart

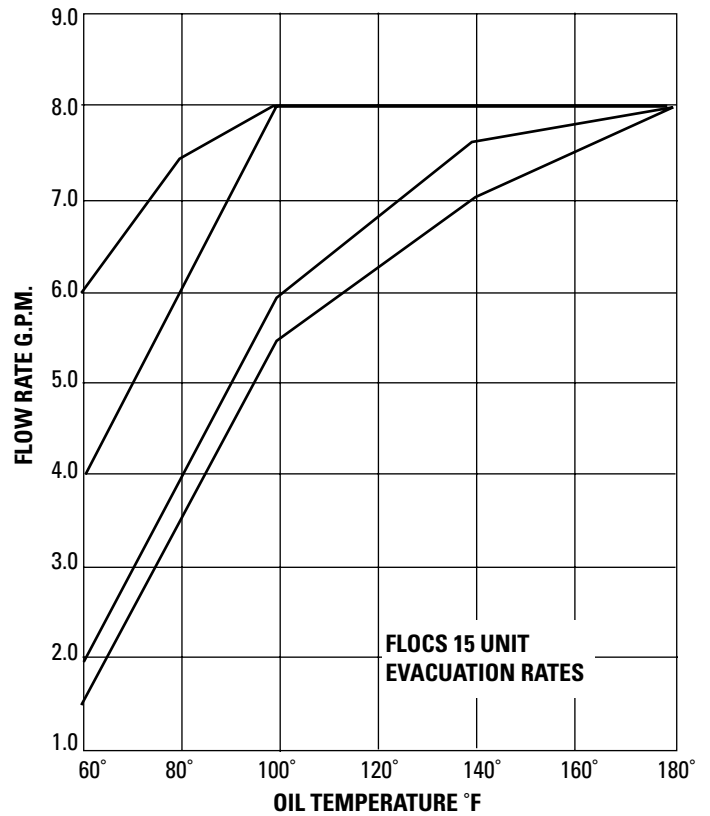

Quick Seal



Table of Contents

PR Series.....	265
TC/MTC/RTC/OTC Series.....	267
H and K Series.....	270

Basic Sealing Methods



End Seal — Seals on End of Tube

- General purpose leak testing
- For air, water, refrigerant



Inside Diameter (I.D.) Seal

- Works well with all test media including helium, air, an most refrigerants and gases
- I.D. sealing usually done with inexpensive, easy to replace O-rings



Outside Diameter (O.D.) Seal

- Full flow, minimal restrictions
- Seals on smooth surface
- Seals have minimal exposure to test medium, last longer in hazardous duty
- Seals are larger and longer for better sealing

QUICK SEAL® Reference Guide

Tube Connector Part	PR	TC	RTC	OTC	MTC
Standard Tube Sizes (inches)	1/4 thru 7/8	1/8 thru 2-1/4	1/4 thru 1	.060 thru 3/8	N/A
Metric Tube Sizes (mm)	7 mm thru 22 mm	3 mm thru 57 mm	7 mm thru 25 mm	2 mm thru 9 mm	4 mm thru 54 mm
Maximum Pressure PSI (BAR)	650 (44)	650 (44)	650 (44)	650 (44)	650 (44)
Vaccum (MICRONS)	10	**	**	**	**
*Sealing Method	O.D.	E	E	O.D.	E

Tube Type

Straight



Expanded



Test Plug/Filling Connector Part	H	K
Standard Bore Sizes (inches)	0.343 thru 4.250	0.343 thru 4.250
Metric Bore Sizes (mm)	9 mm thru 108 mm	9 mm thru 108 mm
Maximum Pressure		
Smooth Bore - PSI (BAR)	50 (3.4)	50 (3.4)
Treaded Bore - PSI (BAR)	100 (6.8)	100 (6.8)
*Sealing Method	I.D.	I.D.

Opening Type

Smooth Bore



Threaded Bore



* Sealing Method: E = End Seal I.D. = Seal on Inside Diameter O.D. = Seal on Outside Diameter

** Not recommended for vacuum applications
For special applications, consult factory

QUICK SEAL®

Tube Connectors – Straight Tube

For pressure testing, vacuum dehydrating and other applications requiring a quick, leak-free connection.

PR

1/4" to 7/8" O.D. (7 mm to 22 mm)
Pressures to 650 PSI (44 BAR)



AMER region



Automatic Self-Locking Retention

No adjustments other than routine maintenance by the operator are ever necessary.

Single 1/4" Long Seal

Lasts longer and provides a greater sealing surface which enables it to withstand the sensitivity of helium leak testing.

Independent Locking and Sealing Actuation

Allows the operator to safely release pressure before removing the connector from the tube.

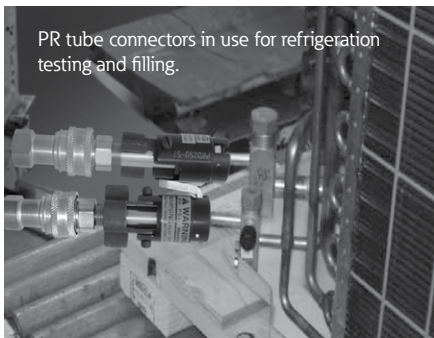

PR tube connectors in use for refrigeration testing and filling.

Designed to provide the sealing necessary for the greater sensitivity of today's demanding leak detection techniques.

- Specially designed for nitrogen, water, helium* and most refrigerants (R12, R22, R134A, R407, R409A, R410, AZ220, AZ250).
- Capable of sealing a 10 micron vacuum, pressures to 650 PSI (44 BAR).
- Exclusive design eliminates need for lubrication, allows easy seal replacement.
- Withstands temperatures from -20° to 250° F (-29° to 121° C).

*Helium leak rate less than 1×10^{-7} cc/sec @ 150 PSI (10 BAR)

QUICK SEAL® Tube Connectors

Straight Tube

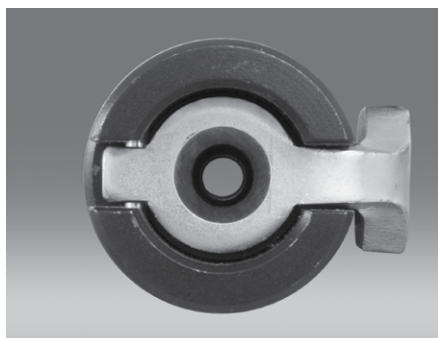

Design allows full flow for quick evacuation and charging. No restrictive small seal or plunger.

Two locking positions for highest possible secured seal:

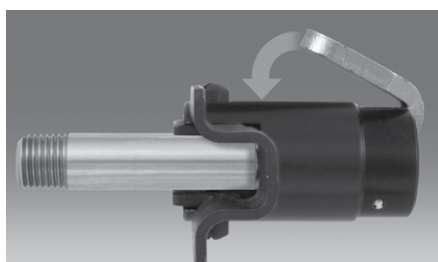

Lock Lever

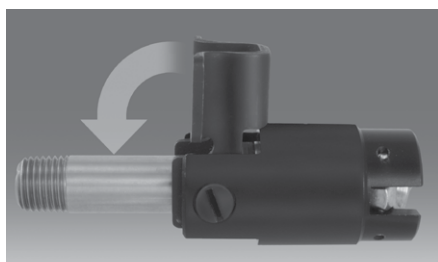

Locking Cam Lever – compresses seal around O.D. of tube.

PR Connectors

The PR Tube Connectors feature the Danfoss automatic self-locking device, which instantly connects seal pressure and vacuum lines to straight end tubing creating a leak-free seal. These units work on the push-on, pull-off principle – the higher the pressure, the tighter the hold.

Connection to tube is instantaneous. Just connect unit to service line, depress the lock lever, push on over tubing, pressing firmly to stop position and actuate cam lever. This automatically locks the tube in place for a leak-free seal, ready for pressure testing, vacuum dehydrating or charging with refrigerant. To disconnect from tubing, relieve test pressure, actuate cam lever 90°, depress lock lever and pull off. It's that simple

Simplified design eliminates lubrication requirements and allows easy seal

replacement, which can be done in seconds. The seal is compressed around the O.D. of tube and actuated by the cam lever independent of the locking mechanism. Since it's not an end type seal, the surface condition of the tube's cutoff end does not affect the seal. It lasts longer and has a greater sealing area to withstand the sensitivity of helium and freon testing.

A quick disconnect can be assembled directly to the male pipe thread inlet port without the need of a short nipple or adapter.

Recommended for a range of services including helium, air, water, vacuum and most refrigerants. The PR is constructed with a heat treated and plated steel lock lever and neoprene seal suitable for temperatures from -20° to 250° F (-29° to 121° C).

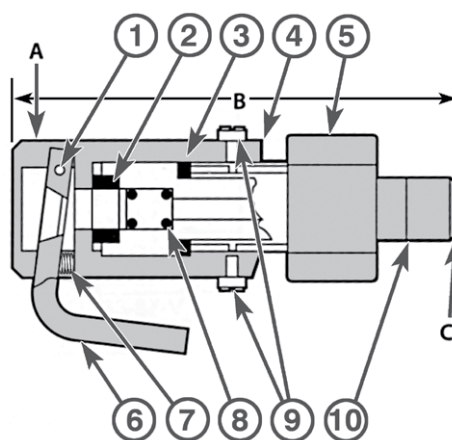

PART material

- ① LEVER PIN hardened and plated steel
- ② SEAL neoprene
- ③ WEAR WASHER hardened and plated steel
- ④ BODY anodized aluminium
- ⑤ CAM LEVER hardened and plated steel
- ⑥ LOCK LEVER hardened and plated steel
- ⑦ LEVER SPRING stainless steel
- ⑧ SPRING stainless steel
- ⑨ SCREWS hardened and plated steel
- ⑩ PISTON stainless steel

Series HK Socket and Plug Option



Part Number*	Tube Size	Minimum Tube Length	Connector Dimensions		
			O.D. (A)	Length (B)	Inlet (C)
PR Series					
PR0250-57	1/4"	1.00"	1.13" rd.	3.50"	1/4" NPT
PR0312-57	5/16"				
PR0375-57	3/8"				
PR0437-57	7/16"	1.13"	1.38" rd.	3.63"	1/4" NPT
PR0500-57	1/2"				
PR0625-57	5/8"				
PR0750-57	3/4"	1.38"	2.00" hex	5.25"	3/4" NPT
PR0875-57	7/8"				

* When ordering, please specify part number, tube O.D., minimum available tube length, test pressure, media and media temperature. Tube O.D. tolerance must be +.003/-0.005 maximum.

QUICK SEAL®

Tube Connectors – Straight Tube Single Motion/High Speed Leak Test Tool

TC/MTC/RTC/OTC

Pressure to 650 PSI (44 BAR)



AMER region

This self-sealing, automatic locking device works on a push-on, pull-off principle. Instantly connects and seals pressure lines.

TC Tube Connectors 1/8" to 2-1/4" O.D. (3 to 57 mm)

The TC Tube Connectors were originally developed for production line use on refrigeration coils, but have also earned overwhelming acceptance for use on compressor units, heat exchangers and any other assemblies which require a quick, easy and efficient way to attach pressure lines to straight end tubing.

RTC Tube Connectors For short length tubes 1/4" to 1" O.D. (7 to 25 mm)

The RTC Tube Connectors have been specially designed for use in applications where only a short length of tube is available for engagement. Just attach the connector to the service line, depress the lock lever and push on over the tubing, until the spring loaded seat and plunger assembly is depressed a minimum of 1/8 inch.

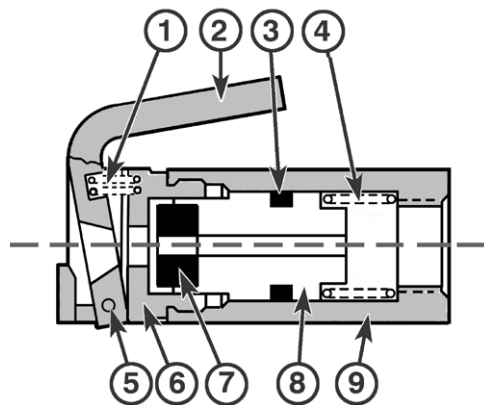

PART material

- ① LEVER SPRING stainless steel
- ② LOCK LEVER hardened and plated steel
- ③ QUAD RING neoprene
- ④ COMPRESSION SPRING stainless steel
- ⑤ LEVER PIN hardened and plated steel
- ⑥ HEAD anodized aluminum
- ⑦ TUBE SEAL neoprene
- ⑧ PLUNGER anodized aluminum
- ⑨ CYLINDER anodized aluminum

QUICK SEAL® Tube Connectors

Straight Tube Single Motion/High Speed Leak Test Tool

OTC with Outside Diameter Type Seal

0.060" to 3/8" O.D. (2 mm to 9 mm)

The OTC Tube Connectors have been designed specifically for use in those applications where there are advantages to making the tube connector's seal on the outside diameter of the tube – for example, where connection has to be made to smooth tubes which do not have square cut ends. They feature a "Full Flow" design with an internal tube stop. A seal is compressed around

the tube by the plunger as it is actuated by the test pressure. In 1500 Series OTC connectors for capillary tubes, a leak-free seal is created by an O-ring which is compressed around the tube by the plunger as it is actuated by the test pressure. A lock lever grips the tube for positive hold.

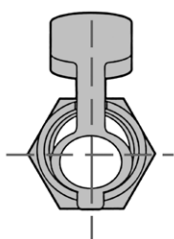
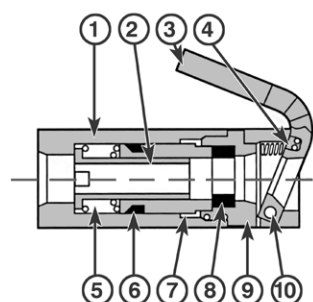

PART material

- ① CYLINDER anodized aluminum
- ② STOP SLEEVE stainless steel
- ③ LOCK LEVER hardened and plated steel
- ④ LEVER SPRING stainless steel
- ⑤ COMPRESSION SPRING stainless steel
- ⑥ QUAD RING neoprene
- ⑦ PLUNGER anodized aluminum
- ⑧ SEAL neoprene
- ⑨ HEAD anodized aluminum
- ⑩ LEVER PIN stainless steel



to 121° C) and are standard; other seal and quad ring materials are available. Also available are STC connectors with stainless steel construction (except the lock lever).

Danfoss TC, RTC and OTC Connectors are recommended for a wide variety of services with air, water and most refrigerants.

Connection to tubing is instantaneous. Just attach the connector to the service line, depress the lock lever and push on over tubing, pressing firmly to the stop position. This automatically locks the tube into place

for a leak-free seal, ready for pressure testing or charging with refrigerant. To disconnect the tubing, relieve the test pressure and then press the lock lever and pull off. It's that simple.

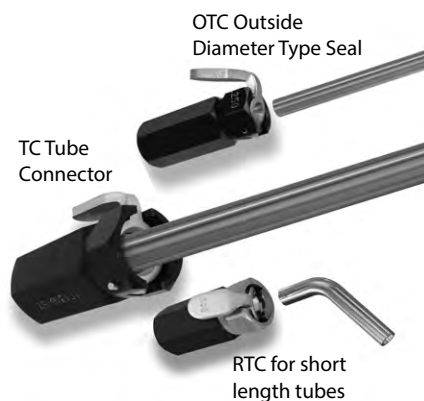

TC, RTC & OTC Connectors

Standard TC, RTC and OTC Connectors are of aluminum construction with a heat treated and plated steel lock lever. Neoprene seals and packing are suitable for temperatures from -20° to 250° F (-29°

QUICK SEAL® Tube Connectors

Straight Tube Single Motion/High Speed Leak Test Tool

Part Number*	Tube Size	Connector Dimensions			
		Minimum Tube Length	Across Flats	Length	Inlet
TC Series					
TC1300-57*	1/8"	1.25"	0.88"	2.38"	1/4" NPT
TC1301-57*	3/16"				
TC1302-57	1/4"	1.00"	0.88"	2.38"	1/4" NPT
TC1303-57	5/16"				
TC1304-57	3/8"				
TC1305-57	1/8" pipe	1.25"	1.25"	3.00"	1/4" NPT
TC1306-57	7/16"				
TC1307-57	1/2"				
TC1308-57	1/4" pipe				
TC1309-57	9/16"				
TC1310-57	5/8"				
TC1311-57	3/8" pipe	1.50"	1.75"	3.88"	3/8" NPT
TC1312-57	11/16"				
TC1313-57	3/4"				
TC1314-57	13/16"				
TC1314-57	13/16"				
TC1316-57"	7/8"				
TC1317-57"	15/16"				
TC1000-57	1"	1.88"	2.25"	5.06"	1/2" NPT
TC1319-57	3/4" pipe				
TC1321-57	1-1/8"				
TC1322-57	1-3/16"				
TC1323-57	1-1/4"				
TC1324-57	1-5/16"				
TC1326-57"	1-3/8"				
TC1327-57"	1-1/2"				
MTC Series					
MTC5060-57	6 mm	25 mm	0.88"	2.38"	1/4" NPT
MTC5070-57	7 mm				
MTC5090-57	9 mm				
MTC5100-57	10 mm				
MTC5120-57	12 mm	32 mm	1.25"	3.00"	1/4" NPT
MTC5150-57	15 mm				
MTC5160-57	16 mm				
MTC5180-57	18 mm	38 mm	1.75"	3.88"	3/8" NPT
MTC5200-57	20 mm				
MTC5220-57	22 mm				
MTC5280-57	28 mm	48 mm	2.25"	5.06"	1/2" NPT
MTC5540-57"	54 mm	57 mm	3.00"	6.13"	3/4" NPT

Part Number*	Tube Size	Connector Dimensions			
		Minimum Tube Length	Across Flats	Length	Inlet
RTC Series					
RTC1602-57	1/4"	0.69"	0.88"	2.38"	1/4" NPT
RTC1603-57	5/16"				
RTC1604-57	3/8"				
RTC1605-57	1/8" pipe	0.88"	1.25"	3.00"	1/4" NPT
RTC1606-57	7/16"				
RTC1607-57	1/2"				
RTC1609-57	9/16"				
RTC1610-57	5/8"				
RTC1616-57	7/8"				
•OTC Series					
OTC2502-57	1/4"	1.00"	0.88"	2.38"	1/4" NPT
OTC2503-57	5/16"				
OTC2504-57	3/8"				
OTC1500-57	.060 – .063"	1.00"	0.88"	2.38"	1/4" NPT
OTC1501-57	.072 – .078"				
OTC1502-57	.081 – .087"				
OTC1503-57	.093 – .099"				
OTC1504-57	.106 – .112"				

* Seal on O.D. of tube

** Pressures to 500 PSI only

*** Pressures to 300 PSI only

♦ When ordering, please specify part number, tube O.D., minimum available length, test pressure, media and media temperature. Tolerance of tube O.D. must be +.003/- .005 maximum.

• For OTC: Tolerance of tube O.D. must be +.002/- .002 maximum.

QUICK SEAL®

Connecto-Valves For Gas Leak Detection

0.343" to 4.25" (9 mm to 108 mm) Bores
 Threaded Holes – Pressures to 100 PSI (6.8 BAR)
 Smooth Bore Holes – Pressures to 50 PSI (3.4 BAR)

H
 Expanding Seal Filling Connectors

K
 Expanding Seal Test Plugs

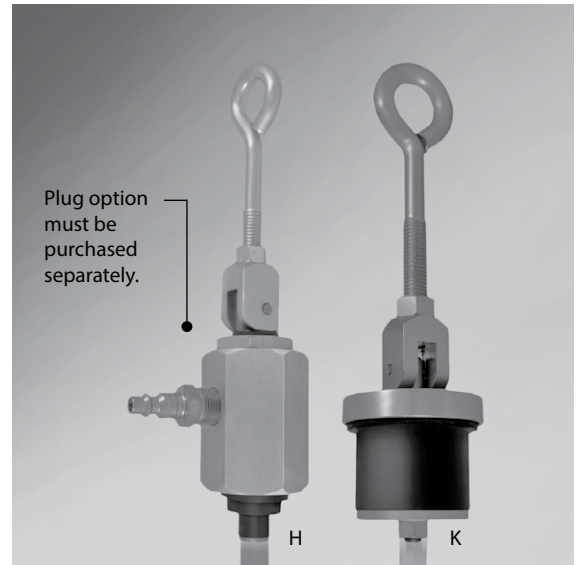

AMER region



H expanding seal filling connector shown servicing an automotive radiator.

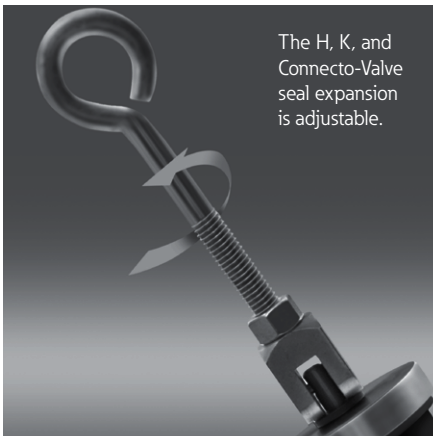

The H, K, and Connecto-Valve seal expansion is adjustable.

H Expanding Seal Filling Connectors

H Expanding Seal Filling Connectors are widely used for adapting and connecting pressure lines to tanks, drums, castings, etc., during leak testing. These tools effectively seal flanges, couplings, blind holes, deep openings or holes with restricted clearance. Actuation of the hand cam lever expands the seal firmly inside an opening, creating a dependable To remove the connector, relieve test pressure and lift cam lever. leak-free connection. Inlet openings are pipe tapped for connecting pressure lines.

Construction materials are aluminum, stainless steel, and plated carbon steel. Neoprene seals are standard.

The connectors are suitable for operation from -20° to 250° F (-29° to 121° C).

K Expanding Seal Test Plugs

K Test Plugs use the same sealing principle, materials of construction and action as the type H filling connector, but do not have an inlet port. They are frequently used in pressure testing rough castings. Seals are made of tough long-wearing neoprene and are easily replaced.

All expanding seal plugs and connectors are ruggedly built to assure long, trouble-free service.

Part Number*	Piped Tapped	Opening To Be Sealed		
		Bore	Min. Depth	Inlet
H2075-57	1/8" NPT	0.339"	0.59"	1/4" NPT
H2076-57	1/4" NPT	0.438"	0.72"	1/4" NPT
H2077-57	3/8" NPT	0.578"	0.72"	1/4" NPT
H2078-57	1/2" NPT	0.719"	0.88"	3/8" NPT
H2079-57	3/4" NPT	0.922"	1.13"	3/8" NPT
H2080-57	1" NPT	1.156"	1.38"	1/2" NPT
H2081-57	1-1/4" NPT	1.500"	1.38"	1/2" NPT
H2082-57	1-1/2" NPT	1.734"	1.69"	1/2" NPT
H2083-57	2" NPT	2.219"	1.69"	1/2" NPT

* To order, specify thread size, depth of hole, test pressure and test media.

Part Number*	Piped Tapped	Opening To Be Sealed	
		Bore	Min. Depth
K2063-57	1/8" NPT	0.339"	0.59"
K2064-57	1/4" NPT	0.438"	0.72"
K2065-57	3/8" NPT	0.578"	0.72"
K2066-57	1/2" NPT	0.719"	0.88"
K2067-57	3/4" NPT	0.922"	1.13"
K2068-57	1" NPT	1.156"	1.38"
K2069-57	1-1/4" NPT	1.500"	1.38"
K2070-57	1-1/2" NPT	1.734"	1.69"
K2071-57	2" NPT	2.219"	1.69"
K9072-57	2-1/2" NPT	2.625"	1.56"
K9073-57	3" NPT	3.250"	1.56"

* To order, specify thread size, depth of hole, test pressure and test media.

Accessories

HK Series

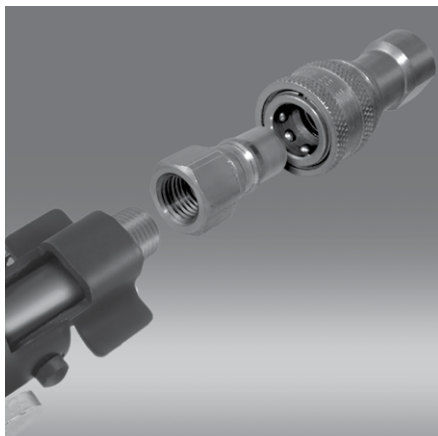

HK Series ISO 7241-1B

HK Series Couplings are designed for general purpose hydraulic service. Some are suitable for use with various liquids, chemicals, steam, gases and vacuum. HK Series couplings conform to the dimensional requirements of the ISO 7241-1 Series B standard.

Body sizes in the chart below range from 1/8" to 1". See our QDC section for the complete product line

Features

- End connections are female NPTF (BSPP also available)

Standard Materials

- Zinc-plated steel construction (also available in brass and stainless steel)
- Stainless steel springs, balls and retaining rings
- Buna-N (Nitrile) seals
- PTFE back-up rings in 1-HK through 8-HK steel sockets

Options

- Bleeder-style plug
- Sleeve lock
- Seals: Ask about availability

Series HK Accessories

- Dust caps and dust plugs



- Release clamp with chain



Rated Pressure and Flow Capacity

Series	Body Size	PSI	BAR
1HK	1/8"	4,000	275
2HK	1/4"	5,000	345
3HK	3/8"	4,000	275
4HKP	1/2"	5,000	345
6HKP	3/4"	4,000	275
8HKP	1"	4,000	275"

Other sizes available.

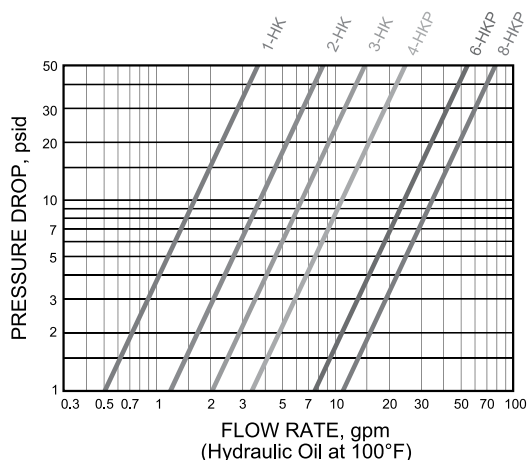

Accessories

HK Series

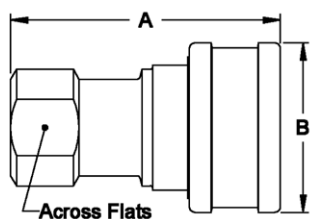

SOCKET

Steel Construction
(also available in brass and stainless steel)

Body Size (inch)	Part Number	Thread Size Female NPTF	Dimensions (inches)		
			A	B	Across Flats
1/8	1H11	1/8-27	1.91	0.98	0.56
1/4	2H16	1/4-18	2.26	1.17	0.75
3/8	3H21	3/8-18	2.56	1.42	0.88
1/2	4HP26	1/2-14	2.96	1.86	1.13
3/4	6HP31	3/4-14	3.48	2.22	1.31
1	8HP36	1-11 1/2	4.13	2.61	1.75

A = Overall length B = Maximum diameter

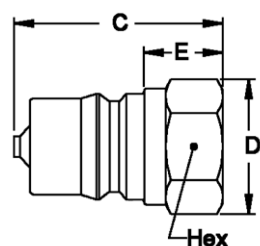

PLUG

Steel Construction
(also available in brass and stainless steel)

Body Size (inch)	Part Number	Thread Size Female NPTF	Dimensions (inches)			
			C	D	E	Hex
1/8	1K11	1/8-27	1.26	0.65	0.44	0.56
1/4	2K16	1/4-18	1.52	0.87	0.56	0.75
3/8	3K21	3/8-18	1.76	1.01	0.61	0.88
1/2	4KP26	1/2-14	2.03	1.30	0.76	1.13
3/4	6KP31	3/4-14	2.36	1.52	0.71	1.31
1	8KP36	1-11 1/2	2.85	1.88	0.97	1.63

C = Overall length D = Maximum diameter E = Exposed length when connected

More plug and socket configurations are available – see our coupling catalog for the complete product line.

Accessories

3000/4000/5000/6000 Series

3000/4000/5000/6000 Series

Industrial Interchange Pin Lock Couplings are designed for compressed air, gases and liquids. Body sizes are 1/4", 3/8", 1/2" and 3/4".

Features

- Easy, automatic, push-to-connect design provides instantaneous connection and disconnection of lines, plus automatic shut-off of socket end of line
- 1/4" and 1/2" sockets accept ISO 6150 Series B and A-59439 plugs/males
- Optional sleeve lock prevents accidental disconnection
- Optional seal and valve materials available

Standard Materials

Socket

- Brass Body
- Zinc Plated Steel Valve
- Buna-N (Nitrile) Seal
- Stainless Steel Springs
- Stainless Steel Locking Pins

Plug

- Zinc Plated Case
- Hardened Steel (All Sizes)
- Brass (All Sizes)
- Stainless Steel (Series 3000)

Accessories

- Dust caps and dust plugs

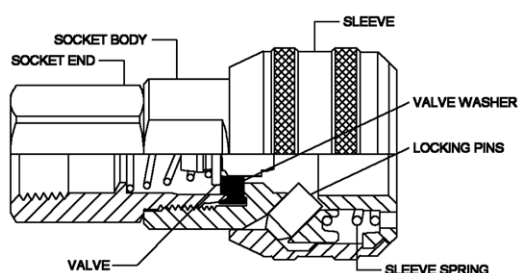
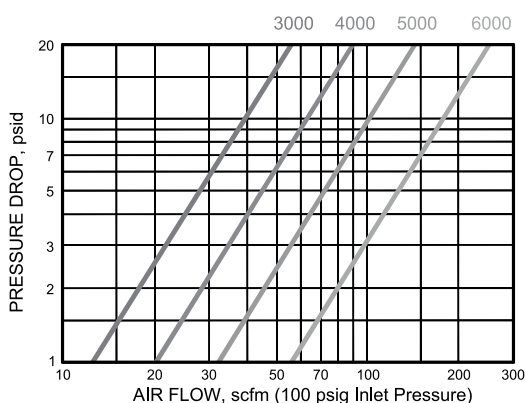

Rated Pressure

Series	Body Size	PSI	BAR
3000	1/4"	2,000	138
4000	3/8"	1,000	69
5000	1/2"	500	35
6000	3/4"	220	15

Flow Capacity

Series	*Scfm
3000	24
4000	45
5000	72
6000	125

* Air flow (scfm) with 5 PSI pressure drop and 100 PSIG inlet pressure.

Accessories

3000/4000/5000/6000 Series

Series 3000 1/4" Nominal

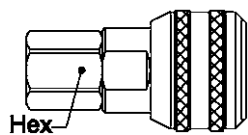

SOCKET - male end connections

Model	Thread Size	Finish
2900	1/8-27 NPTF	Brass
3100E	1/4-18 NPTF	Brass
3300E	3/8-18 NPTF	Brass

Series 4000 3/8" Nominal

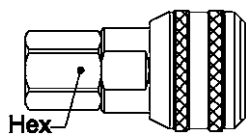

SOCKET - male end connections

Model	Thread Size	Finish
4100A	1/8-27 NPTF	Brass
4100	1/4-18 NPTF	Brass
4300	3/8-18 NPTF	Brass
4500E	1/2-14 NPTF	Brass

Series 5000 1/2" Nominal

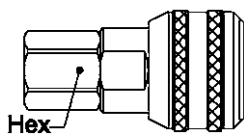

SOCKET - male end connections

Model	Thread Size	Finish
50100	1/4-18 NPTF	Brass
5100E	3/8-18 NPTF	Brass
5300E	1/2-14 NPTF	Brass
5500	3/4-14 NPTF	Brass

Series 6000 3/4" Nominal

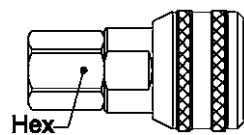

SOCKET - male end connections

Model	Thread Size	Finish
6300	1/2-14 NPTF	Brass
6500	3/4-14 NPTF	Brass
6700E	1-11/2 NPTF	Brass

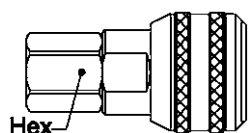

SOCKET - female end connections

Model	Thread Size	Finish
2800	1/8-27 NPTF	Brass
3000	1/4-18 NPTF	Brass
3200	3/8-18 NPTF	Brass

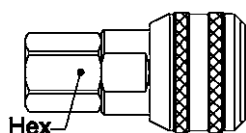

SOCKET - female end connections

Model	Thread Size	Finish
4000A	1/8-27 NPTF	Brass
4000	1/4-18 NPTF	Brass
4200	3/8-18 NPTF	Brass
4400	1/2-14 NPTF	Brass

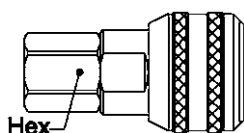

SOCKET - female end connections

Model	Thread Size	Finish
5000A	1/4-18 NPTF	Brass
5000	3/8-18 NPTF	Brass
5200	1/2-14 NPTF	Brass
5400E	3/4-14 NPTF	Brass

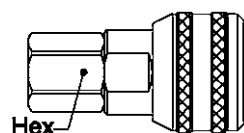

SOCKET - female end connections

Model	Thread Size	Finish
6200E	1/2-14 NPTF	Brass
6400E	3/4-14 NPTF	Brass
6600E	1-11/2 NPTF	Brass



PLUG - male end connections

Model	Thread Size	Finish
10	1/4-18 NPTF	Steel
14	3/8-18 NPTF	Steel
B10	1/4-18 NPTF	Brass
LL10	1/4-18 NPTF	Stainless



PLUG - male end connections

Model	Thread Size	Finish
38	1/8-27 NPTF	Steel
40	1/4-18 NPTF	Steel
42	3/8-18 NPTF	Steel
44	1/2-14 NPTF	Steel
B40	1/4-18 NPTF	Brass
B42	3/8-18 NPTF	Brass

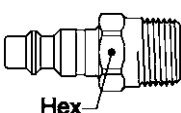

PLUG - male end connections

Model	Thread Size	Finish
50E	1/4-18 NPTF	Steel
52	3/8-18 NPTF	Steel
54E	1/2-14 NPTF	Steel
56	3/4-14 NPTF	Steel
B52	3/8-18 NPTF	Brass
B54	1/2-14 NPTF	Brass



PLUG - male end connections

Model	Thread Size	Finish
64A	1/2-14 NPTF	Steel
66A E	3/4-14 NPTF	Steel
68A	1-11/2 NPTF	Steel
B64A	1/2-14 NPTF	Steel
B66A	3/4-14 NPTF	Brass

More plug and socket configuration are available – see our coupling catalog for the complete product line.

Overall catalog summary

Series	Section	Looking mechanism	Material	Region	Page number
5100	Fluid transfer&Hydraulic	Screw to connect	Brass	Global	95
5600	Fluid transfer&Hydraulic	Ball latch poppet	Carbon steel	AMER	15
5600	Fluid transfer&Hydraulic	Ball latch poppet	Stainless steel	Global	20
2HKIG/2HKIL	Fluid transfer&Hydraulic	Ball latch poppet	Stainless steel	Global	35
FD48	Fluid transfer&Hydraulic	Ball latch poppet	Carbon steel	AMER	47
FD49	Fluid transfer&Hydraulic	Flat face	Steel	AMER	73
FD72/76	Fluid transfer&Hydraulic	Ball latch poppet	Carbon steel	AMER	22
FD85	Fluid transfer&Hydraulic	Screw to connect	Steel	Global	102
FD85	Fluid transfer&Hydraulic	Screw to connect	Stainless steel	Global	102
FD86	Fluid transfer&Hydraulic	Screw to connect	Steel	Global	99
FD96	Fluid transfer&Hydraulic	Flat Face	Steel	Global	75
FF	Fluid transfer&Hydraulic	Flat Face	Steel	Global	61
FFCUP	Fluid transfer&Hydraulic	Flat Face	Steel	Global	66
Safe Breakaway	Fluid transfer&Hydraulic	Flat Face	Stainless steel	EMEA	81
GA90090	Fluid transfer&Hydraulic	Screw to connect	Steel	EMEA	87
H15000	Fluid transfer&Hydraulic	Ball latch poppet	Steel	EMEA	10
H5000	Fluid transfer&Hydraulic	Ball latch poppet	Steel	Global	38
H5000	Fluid transfer&Hydraulic	Ball latch poppet	Brass	Global	41
H5000	Fluid transfer&Hydraulic	Ball latch poppet	Stainless steel	Global	44
HK	Fluid transfer&Hydraulic	Ball latch poppet	Steel	Global	23
HK	Fluid transfer&Hydraulic	Ball latch poppet	Brass	Global	26
HK	Fluid transfer&Hydraulic	Ball latch poppet	Stainless steel	Global	29
HKFR	Fluid transfer&Hydraulic	Ball latch poppet	Carbon steel	Global	34
IA	Fluid transfer&Hydraulic	Ball latch poppet	Steel	EMEA	12
IP	Fluid transfer&Hydraulic	Screw to connect	Stainless steel	EMEA	82
K8000	Fluid transfer&Hydraulic	Flat Face	Steel	EMEA	77
L7000	Fluid transfer&Hydraulic	Ball latch straight through	Steel	EMEA	52
L7000	Fluid transfer&Hydraulic	Ball latch straight through	Brass	EMEA	55
L7000	Fluid transfer&Hydraulic	Ball latch straight through	Stainless steel	EMEA	58
LL2M5	Fluid transfer&Hydraulic	Push to connect	Stainless steel	EMEA	33
LL4KP26	Fluid transfer&Hydraulic	Special short valve	Stainless steel	EMEA	32
MLDB	Fluid transfer&Hydraulic	Flat Face	Stainless steel	Global	79
MLFF	Fluid transfer&Hydraulic	Flat Face	Stainless steel	Global	68
Multi-FF	Fluid transfer&Hydraulic	Multiplate Flat face	Steel	Global	69
Q9000	Fluid transfer&Hydraulic	Flat Face	Steel	EMEA	78
ST	Fluid transfer&Hydraulic	Ball latch straight through	Steel	Global	48
ST	Fluid transfer&Hydraulic	Ball latch straight through	Brass	Global	48
ST	Fluid transfer&Hydraulic	Ball latch straight through	Stainless steel	Global	48
W36000	Fluid transfer&Hydraulic	Screw to connect	Steel	EMEA	83
W46000	Fluid transfer&Hydraulic	Screw to connect	Steel	EMEA	101
W6000	Fluid transfer&Hydraulic	Screw to connect	Steel	Global	89
W6000	Fluid transfer&Hydraulic	Screw to connect	Stainless steel	Global	92
FD35	High pressure	Ball latch	Steel	Global	107
HP3	High pressure	Screw to connect	Steel	Global	105
UH	High pressure	Ball latch	Steel	Global	109
W56000	High pressure	Screw to connect	Steel	Global	106
FD69	Water blast	Ball latch	Steel	Global	111
FD69	Water blast	Ball latch	Stainless steel	Global	111
R4000	Check valves	-	Steel	Global	114
R4000	Check valves	-	Brass	Global	116
R4000	Check valves	-	Stainless steel	Global	118
FD15	Diagnostic	Screw to connect	Brass	Global	121
FD90	Diagnostic	Screw to connect	Steel	Global	123
FF14802 pressure gauge kit	Diagnostic	-	Steel	AMER	125
FS flow sensor	Diagnostic	-	Brass	AMER	127
2500	Breathing air	Ball latch	Stainless steel/Brass and steel	Global	132
FD17	Breathing air	Screw to connect	Stainless steel	Global	129
FD17	Breathing air	Screw to connect	Aluminium	Global	129
Safe Breathe	Breathing air	Push to connect	Stainless steel	Global	130
ADB	Thermal management	Flat Face	Aluminium	Global	134
FD83	Thermal management	Bajonette	Steel	Global	136
Flo-Temp	Thermal management	Thread to connect	Brass	AMER	140
UQD	Thermal management	Push to connect	Stainless steel	Global	138
5400	Refrigerant	Thread to connect	Steel	Global	144
LF	Industrial gas	Thread to connect	Aluminium+Brass	Global	150
600/700	Industrial gas	Thread to connect	Brass	AMER	201
2HKGL	Food and beverage	Push to connect	Stainless steel	EMEA	153
100	Pneumatic	Push to connect	Brass	AMER	209
1000/400/500	Pneumatic	Ball latch	Brass/Steel	Global	170
180/280	Pneumatic	Push to connect	Brass	AMER	211
210/310	Pneumatic	Push to connect	Zinc plated carbon steel	AMER	206
2RL/3RL	Pneumatic	Push to connect with ring lock sleeve	Zinc plated steel	AMER	217
3000/4000/5000/6000	Pneumatic	Push to connect	Brass	Global	187
Adapters	Pneumatic	Accessory	-	EMEA	225
AutoFlo23/24	Pneumatic	Push to connect	Brass	Global	197
Blow guns	Pneumatic	Accessory	-	EMEA	224
Flex-air	Pneumatic	Accessory	-	AMER	222
Full Bore	Pneumatic	Push to connect	Zinc plated carbon steel	AMER	213
G600/900/T1100/T1300	Pneumatic	Ball latch	Brass	EMEA	178
Gas-mate	Pneumatic	Push to connect	Brass	AMER	215
Safeline GD/ID10500	Pneumatic	Push button	Aluminium/Brass	Global	159
Safeline GD18500	Pneumatic	Push button	Aluminium/Brass	Global	164
Safeline ID10900	Pneumatic	Push button	Aluminium/Brass	Global	162
Safeline ID18900	Pneumatic	Push button	Aluminium/Brass	Global	166
Safeline TD18300	Pneumatic	Push button	Aluminium/Brass	Global	168
FD14	FLOCs section	Push to connect	Carbon steel	AMER	231
FLOC5	FLOCs section	-	-	AMER	230
H and K	Quick seal section	-	-	AMER	258
PR	Quick seal section	-	-	AMER	252
TC/MTC/RTC/OTC	Quick seal section	-	-	AMER	254

About

Danfoss Power Solutions

Danfoss Power Solutions is a global manufacturer and supplier of high-quality hydraulic and electric components. We specialize in providing state-of-the-art technology and solutions that excel in the harsh operating conditions of the mobile off-highway market as well as the marine sector. Building on our extensive applications expertise, we work closely with you to ensure exceptional performance for a broad range of applications. We help you and other customers around the world speed up system development, reduce costs and bring vehicles and vessels to market faster.

We offer you expert worldwide support for ensuring the best possible solutions for outstanding performance. And with an extensive network of Global Service Partners, we also provide you with comprehensive global service for all of our components.

Danfoss Power Solutions – your strongest partner in mobile hydraulics and mobile electrification.

Products we offer:

- Aeroquip by Danfoss
- Boston by Danfoss
- Danfoss Hansen
- Danfoss Waltech
- DCV directional control valves
- Electric converters
- Electric machines
- Electric motors
- Hydrostatic motors
- Hydrostatic pumps
- Orbital motors
- PLUS+1® controllers
- PLUS+1® displays and sensors
- PLUS+1® joysticks and pedals
- PLUS+1® operator interfaces
- PLUS+1® software services, support and training
- PLUS+1® software
- Position controls and sensors
- PVG proportional valves
- SEL by Danfoss
- Steering components and systems
- Synflex by Danfoss
- Telematics
- Weatherhead by Danfoss
- Winner by Danfoss

Go to www.danfoss.com for further product information.

Danfoss Power Solutions (US) Company

2800 East 13th Street
Ames, IA 50010, USA
Phone: +1 515 239 6000

Danfoss Power Solutions ApS

Nordborgvej 81
DK-6430 Nordborg, Denmark
Phone: +45 7488 2222

Danfoss Power Solutions GmbH & Co. OHG

Krokamp 35
D-24539 Neumünster, Germany
Phone: +49 4321 871 0

Danfoss Power Solutions Trading (Shanghai) Co. Ltd.

Building #22, No. 1000 Jin Hai Rd
Jin Qiao, Pudong New District
Shanghai, China 201206
Phone: +86 21 3418 5200